



Jazz 510/610 Crossbar

en **Walking aids**
Service Manual

I General

en

I.1 About this manual

This manual belongs to an Invacare accessory and it contains important information about handling and assembly. In order to ensure safety when using the product, read the user manual of the related product carefully and follow the safety instructions.

Symbols in this manual

In this user manual, warnings are indicated by symbols. The warning symbols are accompanied by a heading that indicates the severity of the danger.



WARNING

Indicates a hazardous situation that could result in serious injury or death if it is not avoided.



CAUTION

Indicates a hazardous situation that could result in minor or slight injury if it is not avoided.



IMPORTANT

Indicates a hazardous situation that could result in damage to property if it is not avoided.



Tips and Recommendations

Gives useful tips, recommendations and information for efficient, trouble-free use.



Gives information about the required tools.

I.2 General warnings



Risk of damage to the product

Damage to the brake wires

- If needed, always fold the crossbar downwards to protect the cable when the rollator is not used as a walking aid.



Risk of damage to the product

- When using the crossbar on Jazz 510, be careful when opening the crossbar if the handles are adjusted in the lowest position. The crossbar can hit the ground and get damaged when opened.

2 Assembly

2.1 Removing the brakes

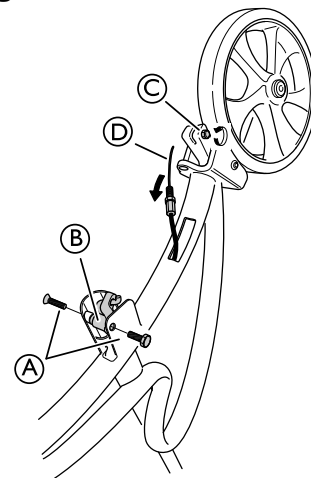

1. Loosen and remove the screw and sleeve nut (A) and the plastic bushing (B) for the wire holder .



allen key 4 mm + 10 mm fixed spanner

2. Loosen the screw for brake pad (C).



allen key 3 mm



DEALER: Keep this manual.

The procedures in this manual MUST be performed by a qualified technician.



Yes, you can.

- Loosen the wire **D** from the brake pad.

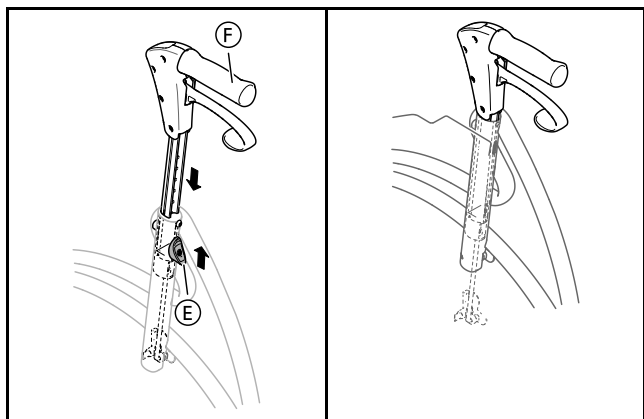

- Push the height adjustment button **E** upwards .
- Lower the handle **F** to the lowest position in order to easily get access to the wire holder and brake rod.

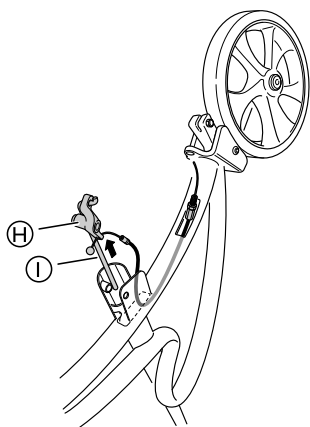

- Remove the wire holder **H** and the brake rod **I**.

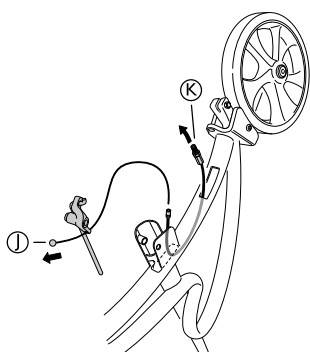

- Remove the existing wire **J** from the wire protection.
- Remove the empty wire protection **K**.

 fixed spanner 10 mm

- Repeat the procedure on the opposite side.

2.2 Mounting the crossbar

Removing the existing handles

-

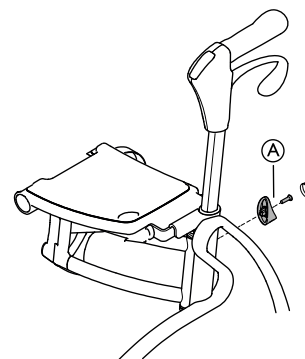

Loosen the screw and remove the height adjustment button **A**.

 allen key 2,5 mm

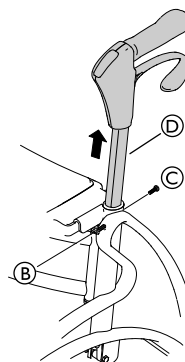

- Loosen the adjustment screw **B**.

 allen key 3 mm

- Loosen and remove the attachment screw for the handle **C**.

 allen key 4 mm

- Remove the existing handle **D**.
- Repeat the procedure on the opposite side.

Mounting the crossbar

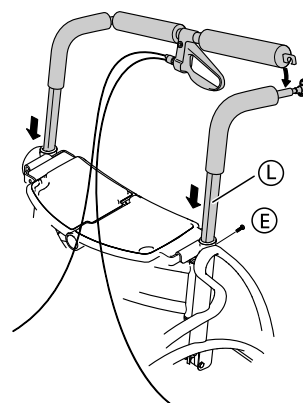

- Mount the crossbar **L**.
- Tighten the screws for the handles **E**.

 allen key 4 mm

3.

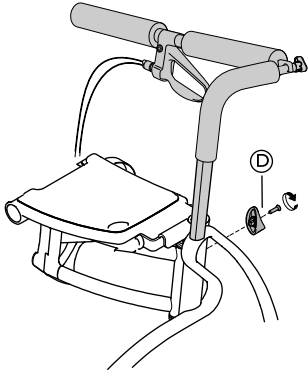

Mount the adjustment button **D** and tighten the screw.

 allen key 2,5 mm

4.

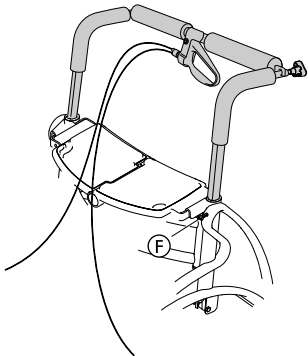

Tighten the adjustment screws **F** in order to remove the free play in the handle.

 Make sure that the height adjustment works smoothly after adjustment of the screw.

 allen key 3 mm

5. Repeat the procedure on the other side.

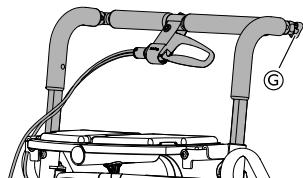

6. Tighten the knob **G**.

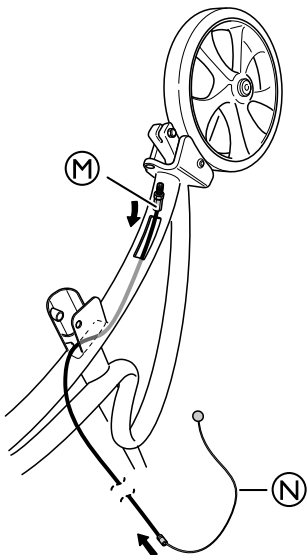

7. Thread the new wire protection **M** through the frame from the rear fork to the front.

 The longer part of the wire protection must be threaded on the side where the crossbar is opened. The shorter part of the wire protection is threaded on the opposite side.

8. Thread the new double wire **N** through the wire protections **M**.

 The upper wire must be threaded through the shorter wire protection and the lower wire must be threaded through the longer wire protection.

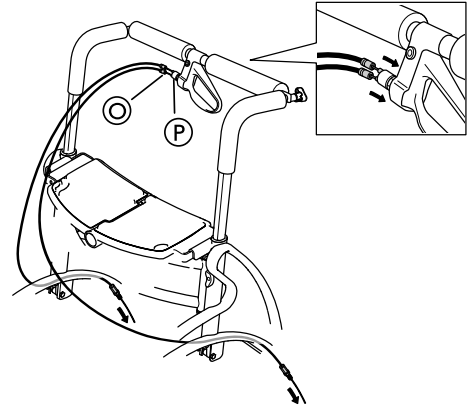

9. Mount the top of the double wire **O** in the attachment **P**.

 Make sure the wire protection is pushed into the attachment **P**.

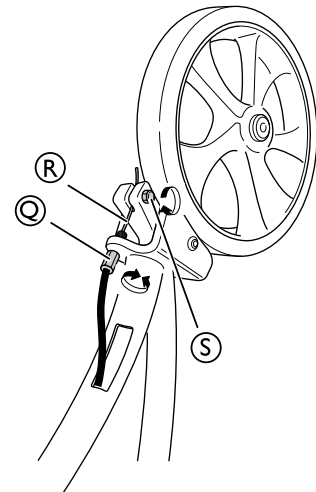

10. Mount the wire protection to the frame **O**.

 fixed spanner 10 mm

11. Mount the wire **R** in the brake pad.

12. Tighten the screw **S**

 allen key 3 mm

13. Repeat the procedure on the opposite side.

14.

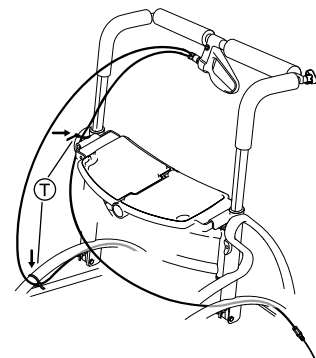

Attach the wires to the frame with cable ties **T**.

2.3 Adjusting the brake effect



WARNING!

Risk of injury

Poor brake effect

- Always adjust the brake effect after mounting or adjusting the brake system.

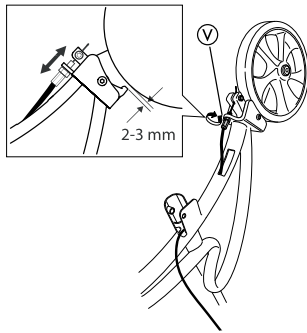

- I. Adjust the brake effect with the adjustment nut (V).



Distance between the brake pad and the wheel should be 2–3 mm.



fixed spanner 8 mm + 10 mm

Invacare Sales Companies

Ireland:

Invacare Ireland Ltd,
Unit 5 Seatown Business Campus
Seatown Road, Swords, County
Dublin
Tel : (353) | 810 7084
Fax: (353) | 810 7085
ireland@invacare.com
www.invacare.ie

United Kingdom:

Invacare Limited
Pencoed Technology Park, Pencoed
Bridgend CF35 5AQ
Tel: (44) (0) 1656 776 222
Fax: (44) (0) 1656 776 220
uk@invacare.com
www.invacare.co.uk



Manufacturer:

Invacare Rea AB
Växjövägen 303
SE-343 71 Diö
Sweden

1582610-A 2016-02-22



Making Life's Experiences Possible™

DOLOMITE

INVACARE
Yes, you can.