

Invacare® LiNX

DLX-REM400, Supplement to power wheelchair user manual

en Remote
User Manual

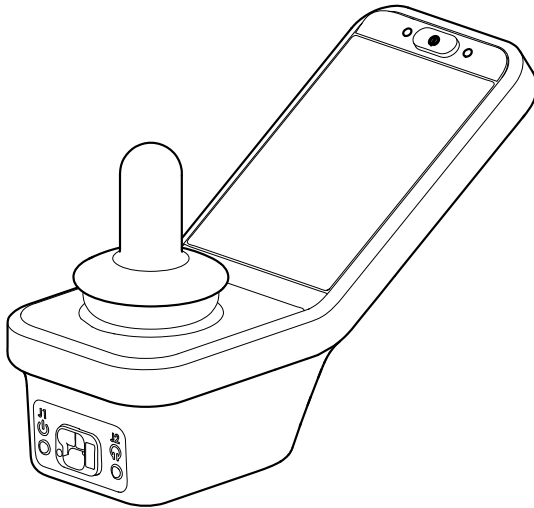

This manual **MUST** be given to the user of the product.
BEFORE using this product, this manual **MUST** be read and saved for future reference.



Yes, you can.®

© 2019 Invacare Corporation

All rights reserved. Reproduction, duplication or modification in whole or in part is prohibited without prior written permission from Invacare. Trademarks are identified by ™ and ®. All trademarks are owned by or licensed to Invacare Corporation or its subsidiaries unless otherwise noted.

Contents

1 General	5
1.1 About This Manual	5
1.2 Symbols in this manual	5
1.3 Warranty Information	5
1.4 Service Life	5
1.5 Limitation of Liability	6
2 Safety	7
2.1 General safety notes	7
3 Components	9
3.1 User interface REM400	9
3.2 Screen composition overview	9
3.2.1 Battery bar	10
3.2.2 Status Bar	10
3.2.3 User Function Card Overview	11
3.3 Navigation button	15
3.4 Labels on the Product	16
4 Setup	20
4.1 General information on setup	20
4.2 Wiring	20
4.3 Connecting the remote	21
5 Usage	22
5.1 Operating the remote	22
5.1.1 Controls on Menu Screen	23
5.1.2 Settings on Menu Screen	23
5.1.3 Configuring Menu Screen	26
5.1.4 Locking Screen to Avoid Unintentional Response	27
5.2 Navigating through user function cards	28
5.2.1 Function Change Inhibits	28
5.2.2 Using direct navigation	29
5.2.3 Using indirect navigation	31
5.2.4 Menu select	32
5.2.5 Overview scan select	35
5.2.6 Scan select	35
5.3 Using the multipurpose buttons	38
5.4 Using the Toggle Switches (Optional)	38
5.5 Proportional driving mode	39
5.5.1 Using the joystick	39
5.5.2 Controlling the maximum speed	40
5.6 Latched driving mode	41
5.6.1 External stop switch	42
5.6.2 1 Step Up	43
5.6.3 3 Step Up	44
5.6.4 5 Step Up	44
5.6.5 3 Step Up/Down	45
5.6.6 5 Step Up/Down	46
5.6.7 Cruise Control	46
5.7 Emergency stop	47
5.8 Operating the position lights	47
5.9 Operating the hazard lights	49
5.10 Operating the direction indicators	50
5.11 Operating the horn	52
5.12 Operating Lighting Functions and Horn via Utility Function Card	52
5.13 Locking/unlocking the remote	52
5.14 The sleep mode	53
5.15 Operating powered seating functions	54
5.15.1 Through Seating Cards	54
5.15.2 Through External Switches	56
5.15.3 Speed Reduction and Seating Function Inhibits	60
5.16 Connectivity Cards	62
5.16.1 Configuring Connectivity Card	62
5.16.2 Mouse Mover	70
5.16.3 Switch Control	75
5.17 Using secondary inputs	81
5.17.1 Using Manual Swing-Away Chin Control	82
5.17.2 Using Powered Swing-Away Chin Control	83
5.17.3 Using the Compact Single Switch Joystick	85

5.17.4	Using Micro Extremity Control Joystick	85
5.17.5	Using Pediatric Compact Joystick	86
5.17.6	Using the Sip-N-Puff	87
5.17.7	Using the Sip-N-Puff Head Array	89
5.17.8	Using the Head Array	91
5.17.9	Using the Four Switch Proximity Array	93
5.17.10	Using the Remote Stop Switch	94
5.17.11	Using the Wireless Mouse Emulator	95
5.18	Disabling Bluetooth	97
5.19	Charging the Batteries	97
5.19.1	Battery alarms	98
5.20	Using the USB charger	99
6	Maintenance	101
6.1	Replacing Mouthpiece	101
6.2	Replacing Saliva Trap	101
6.3	Cleaning Sip-N-Puff	102
7	Troubleshooting	103
7.1	Fault diagnosis	103
7.1.1	Fault Codes and Diagnosis Codes	103
7.2	OON (“Out Of Neutral”)	105
8	Technical Data	106
8.1	Technical specifications	106

1 General

1.1 About This Manual

This document is a supplement to the power wheelchair's documentation.

The product itself does not bear a CE mark but is part of a product that complies with Directive 93/42/EEC concerning medical devices. It is therefore covered by the power wheelchair's CE marking. See the power wheelchair's documentation for more information.

Invacare reserves the right to alter product specifications without further notice.

Before reading this document, make sure you have the latest version. You find the latest version as a PDF on the Invacare website.

For more information about the product, for example product safety notices and product recalls, contact your Invacare representative. See addresses at the end of this document.

1.2 Symbols in this manual

In this manual, hazard statements are indicated by symbols. The symbols are accompanied by a signal word that indicates the severity of the risk.



WARNING

Indicates a hazardous situation that could result in serious injury or death if it is not avoided.



CAUTION

Indicates a hazardous situation that could result in minor or slight injury if it is not avoided.



IMPORTANT

Indicates a hazardous situation that could result in damage to property if it is not avoided.



Gives useful tips, recommendations and information for efficient, trouble-free use.



This symbol identifies a list of various tools, components and items which you will need in order to carry out certain work.

1.3 Warranty Information

We provide a manufacturer's warranty for the product in accordance with our General Terms and Conditions of Business in the respective countries.

Warranty claims can only be made through the provider from whom the product was obtained.

1.4 Service Life

We estimate a service life of five years for this product, provided it is used in strict accordance with the intended use as set out in this document and all maintenance and service requirements are met. The estimated service life can be exceeded if the product is carefully used and properly maintained, and provided technical and scientific advances

do not result in technical limitations. The service life can also be considerably reduced by extreme or incorrect usage. The fact that we estimate a service life for this product does not constitute an additional warranty.

1.5 Limitation of Liability

Invacare accepts no liability for damage arising from:

- Non-compliance with the user manual
- Incorrect use
- Natural wear and tear
- Incorrect assembly or set-up by the purchaser or a third party
- Technical modifications
- Unauthorised modifications and/or use of unsuitable spare parts

2 Safety

2.1 General safety notes

**WARNING!****Risk of injury or damage to the mobility device**

Do not install, maintain or operate this equipment before you have read and understood all the instructions and all the manuals for this product and all other products that you use or install together with this product.

- Follow the instructions in the user manuals.

**WARNING!****Risk of serious injury or damage to the mobility device or surrounding property**

Wrong settings can make the mobility device uncontrollable or unstable. An uncontrolled or unstable mobility device can cause an unsafe situation such as a crash.

- Performance adjustments must only be made by qualified technicians or by persons who completely understand the programming parameters, the adjustment process, the configuration of the mobility device and the capabilities of the driver.
- Performance adjustments must only be made in dry conditions.

**WARNING!****Risk of injury or damage due to electrical shorts**

Connector pins on cables connected to the power module can still be live even when the system is off.

- Cables with live pins should be connected, restrained or covered (with non-conductive materials) so that they are not exposed to human contact or materials that could cause electrical shorts.
- When cables with live pins have to be disconnected, for example, when removing the bus cable from the remote for safety reasons, make sure to restrain or cover the pins (with non-conductive materials).

**CAUTION!****Risk of injury from hot surfaces**

Remote module can get hot when exposed to strong sunlight for long periods.

- Do not leave mobility device in direct sunlight for long periods.

**Risk of damage to the connector pins**

If you touch the connector pins, they can become dirty or they can be damaged by electrostatic discharge.

- Do not touch the connector pins.



Risk of damage to the mobility device

There are no user-serviceable parts inside any case.

- Do not open or disassemble any case.

3 Components

3.1 User interface REM400

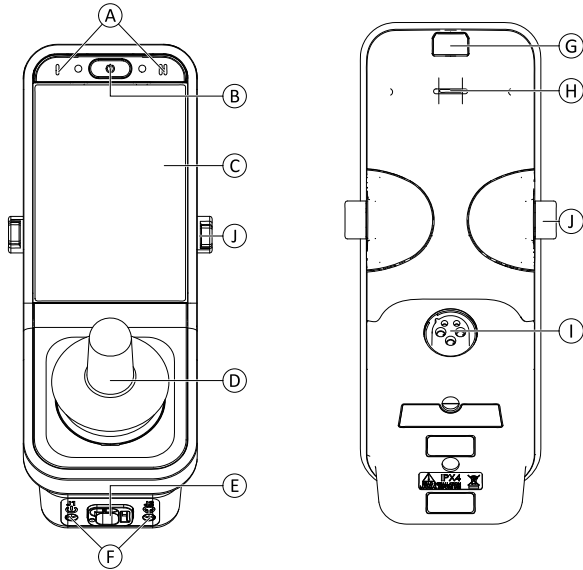

- Ⓐ Multipurpose buttons
- Ⓑ ON/OFF button/Status LED
- Ⓒ Touch display
- Ⓓ Joystick

- Ⓔ Bus socket
- Ⓕ Stereo jack sockets
- Ⓖ Infrared transmitter
- Ⓗ Speaker
- Ⓘ Charger socket
- ⓰ Toggle switches



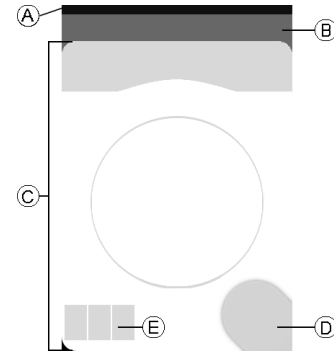

3.2 Screen composition overview



- Ⓐ Battery bar
- Ⓑ Status bar
- Ⓒ User function card
- Ⓓ Navigation button
- Ⓔ Function information

3.2.1 Battery bar

The battery bar provides a graphical display of the battery's current state of charge and, when a battery charger is connected, the charging status.

	Battery bar displays green when state of charge is between 60 and 100%.
	Battery bar displays orange when state of charge is between 20 and 59%.
	Battery bar displays red when state of charge is less than 20%.
	Charging.

3.2.2 Status Bar

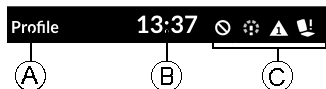

Fig. 3-1

- Ⓐ Profile name
- Ⓑ Time
- Ⓒ Status information

Profile Name



The profile name can only be set by the provider.



Time

The time is displayed as a 12- or 24-hour clock. It is set using the coordinated universal time (UTC) and an offset based on the location (country) of the user. The UTC is automatically acquired when a system is connected to a programming and diagnostic tool. The country-based offset is set through the remote module's Menu screen. See 5.1.2 *Settings on Menu Screen, page 23.*

Status Information

The status information displays the current state of the LiNX system with status icons.

	This notifies you that a drive lock-out is active. A drive lock-out is a state that prevents the wheelchair being driven. See 5.15.3 <i>Speed Reduction and Seating Function Inhibits, page 60</i> for more information about lock-outs and slow-downs.
	This notifies you that a drive slow-down is active. A drive slow-down is a state that prevents the wheelchair being driven at maximum speed for safety reasons. Instead, the wheelchair is allowed to drive at a reduced speed for the duration of the active drive slow-down. See 5.15.3 <i>Speed Reduction and Seating Function Inhibits, page 60</i> for more information about lock-outs and slow-downs.

	<p>This notifies you that a fault occurred. The number indicates the type of fault. See <i>7.1.1 Fault Codes and Diagnosis Codes, page 103</i> for more information about fault codes.</p>
	<p>This notifies you that a seating lock-out is active. A seating lock-out is a state that prevents the wheelchair's seating being operated. See <i>5.15.3 Speed Reduction and Seating Function Inhibits, page 60</i> for more information about lock-outs and slow-downs.</p>
	<p>This notifies you that Bluetooth connectivity is disabled. See <i>5.18 Disabling Bluetooth, page 97</i> for more information about disabling Bluetooth.</p>

Three battery alarms are shown on the right-hand side of the status bar. See *5.19.1 Battery alarms, page 98*.

3.2.3 User Function Card Overview

Left- or Right-Handed

With the LiNX system, it is possible, to adjust the function cards for left-handed or right-handed users. See *5.1.3 Configuring Menu Screen, page 26*.



Fig. 3-2 Left-handed



Fig. 3-3 Right-handed



Be aware, that in the following manual right-handed function cards are displayed only. All buttons have the same functions for right- and left-handed, so the descriptions can be used for left-handed users, too.

Function Card Header

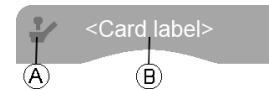







Fig. 3-4

The function card type is identified by the color of the function card's header:

- green indicates a drive card,
- orange indicates a seating card,
- blue indicates a connectivity card, and
- purple indicates a utility card.

The icon (A) indicates the type of primary input.

The text **ⓑ** is programmable by your provider and can be used to name the function.

Indicator	Meaning
	DLX-REM400 DLX-REM500
	DLX-REM2xx DLX-CR400 DLX-CR400LF
	DLX-ACU200
	Input module or third-party interface
	Head Array
	Sip and Puff
	User switch

Drive Card





Fig. 3-5

Drive cards can be pre-set with different maximum speeds to fit your needs and your environment. For example a drive card with pre-set lower maximum speed can be used for indoors and a drive card with pre-set total maximum speed for outdoors. In addition to that you can also control the pre-set maximum speed, see *5.5.2 Controlling the maximum speed, page 40*.

With a drive card you are also able to sound the horn and to operate the lighting functions. See *5.11 Operating the horn, page 52* and *5.8 Operating the position lights, page 47*.

The function information displays either the latched driving mode, see *5.6 Latched driving mode, page 41* or the Gyro indication, see table below.

no symbol	No Gyro is connected to the system or enabled for drive function.
	Gyro disabled.
	Gyro enabled.

Seating Card



Fig. 3-6

Seating cards are for operating the seating functions, see *5.15.1 Through Seating Cards, page 54.*

Connectivity Card



Fig. 3-7 Mouse Mover function



Fig. 3-8 Switch Control function

Connectivity cards allow you to communicate with external devices. The connectivity functions that are supported by your remote are Mouse Mover and Switch Control. By default, these functions are disabled. Contact your provider to change the configuration.

The mouse mover allows you to control the cursor on a PC or laptop's screen with a user input on the wheelchair, such as the joystick on the remote module or an external joystick.

Switch control is an accessibility feature that allows you to navigate and select items on your iOS or Android device using the remote's joystick or touch screen.

For more information about Connectivity cards and how to use them, see *5.16 Connectivity Cards, page 62.*

Utility Card

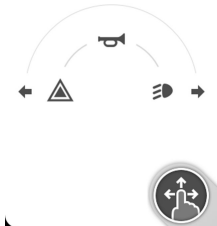

Fig. 3-9 Example of a three-quadrant (3Q) navigation utility card



Fig. 3-10 Example of a four-quadrant (4Q) navigation utility card

Utility card allows you to operate system controls (such as lighting functions and horn) as well as control outputs with external inputs. The utility card function is suitable for both three-quadrant (3Q) and four-quadrant (4Q) inputs.

Utility card allows you to operate two controls / outputs per quadrant, according to the duration that the user input is activated:

- Ⓐ Short press / Momentary press, and
- Ⓑ Long press.

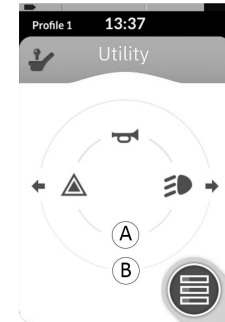

Fig. 3-11

By default, this function is only enabled for chair configurations with an external control input that will not allow the control of horn or lights. Contact your provider to change the configuration and to set up your desired operations.

For an example how to use an utility card in daily use, see 5.12 *Operating Lighting Functions and Horn via Utility Function Card*, page 52.

Arrangement

		Function cards					
		F1	F2	F3	F4	F5	F6
Pro- files	P1						
	P2						
	P3						
	P4						

User function cards are arranged in rows of profiles. Each profile can hold user function cards, which can be of the same type, for example all drive cards, or can be a mixture of drive, seating and connectivity cards.

The maximum number of function cards across all profiles is 40. In a configuration with five profiles, for example, each profile can hold up to eight function cards.

3.3 Navigation button

Depending on the configuration of the remote module and the user's needs, the navigation button is displayed bottom-left or bottom-right on the screen.

When activated, the navigation button changes its color from grey to blue.

The navigation button has two important functions:

1. A visual indication of the configured interaction mode.



Configured for swipe-and-tap actions

This means, that swiping and tapping the screen activates different functions.



Configured for tap actions

This means, that only tapping the screen activates different functions. Swipe inputs are ignored.



For more information about changing the interaction mode, refer to [5.1.2 Settings on Menu Screen, page 23](#).

2. A navigation function depending on context and activation duration. For example, a short press on the navigation button, while viewing an active user function card, opens the card preview display, refer to [5.2 Navigating through user function cards, page 28](#). A long press opens the status screen, refer to [5.1.2 Settings on Menu Screen, page 23](#).

Additional to the touch display, external inputs can be used to interact with the system, refer to [5.17 Using secondary inputs, page 81](#).

3.4 Labels on the Product

Labels on Dynamic Controls' Parts

Labels of Dynamic Controls' parts are located on rear side of the part. Depending on the part not all labels are available.

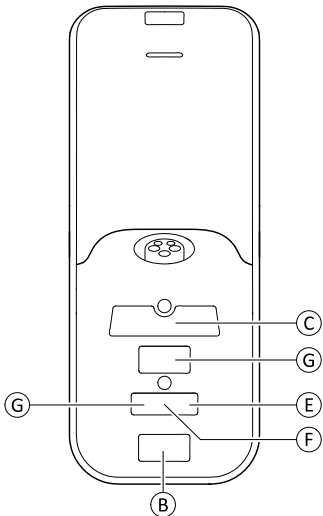

Fig. 3-12 Rear side of DLX-REM400

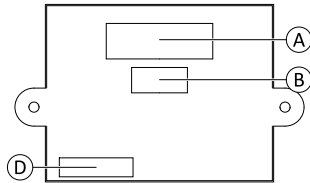



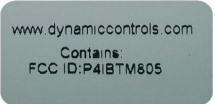

Fig. 3-13 Rear side of DLX-IN500 input module

<p>(A)</p>		<p>Product label containing:</p> <ol style="list-style-type: none"> 1. Part number 2. Dynamic Controls logo 3. Dynamic Controls' part description 4. Dynamic Controls' website address 5. Serial number 6. Warning to read manual before use 7. Ingress protection rating 8. WEEE symbol
<p>(B)</p>		<p>Hardware and application firmware version label:</p> <ol style="list-style-type: none"> 1. Hardware version 2. Hardware major version 3. Hardware minor version 4. Application version 5. Application major version 6. Application minor version

<p>Ⓒ</p>		<p>Product label containing:</p> <ul style="list-style-type: none"> • Dynamic Controls' logo • The product's bar code • The product's serial number • The product's part number
<p>Ⓓ</p>		<p>Tamper evident seal.</p>

<p>Ⓔ</p>		<p>This is the WEEE symbol (Waste Electrical and Electronic Equipment Directive).</p> <p>This product has been supplied from an environmentally aware manufacturer. This product may contain substances that could be harmful to the environment if disposed of in places (landfills) that are not appropriate according to legislation.</p> <ul style="list-style-type: none"> • The 'crossed out wheelee bin' symbol is placed on this product to encourage you to recycle wherever possible. • Please be environmentally responsible and recycle this product through your recycling facility at its end of life.
<p>Ⓕ</p>	<p>IPX4</p>	<p>This is the enclosure's ingress protection rating.</p>

<p>Ⓒ</p>	 <p>READ INSTALLATION MANUAL BEFORE USE</p>	<p>Recommendation to read the instruction manual before using the module.</p>
<p>Ⓗ</p>		<p>Product label containing:</p> <ul style="list-style-type: none"> • Dynamic Controls' website address • Dynamic Controls' Bluetooth registration

Serial number and date of manufacture

The serial number on a Dynamic Controls product provides both the date of manufacture as well as a unique serial number for the particular module.

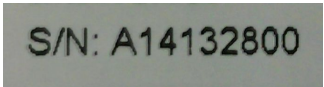

The format, as shown above, is **MYynn timer**, where:

- **M** is for the month of manufacture, using the letters A to L (A = Jan, B = Feb, C = Mar, etc.),
- **YY** is the year of manufacture,
- **nnnnnn** is a unique six digit sequential number.

For example, the remote's serial number, as shown above, begins with A14 indicating that it was manufactured in January 2014, and its unique, sequential value is 132800.

Labels on Toggle Switches

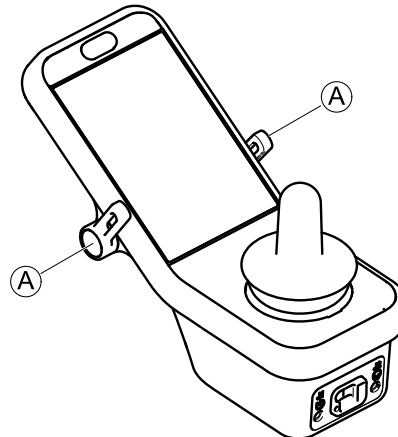







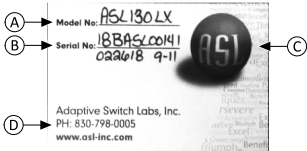

Fig. 3-14

<p>Ⓐ</p>		<p>Power</p>
		<p>Speed pot left</p>
		<p>Speed pot right</p>
		<p>Function and profile</p>
		<p>Seating</p>
		<p>Blank</p>

Labels on Adaptive Switch Labs' Parts

Labels of Adaptive Switch Labs' parts are located either on left rear side of the part (head arrays) or the interface box. Depending on the used part not all labels are available.

	<p>Product label (head array) containing:</p> <ul style="list-style-type: none"> • A: Adaptive Switch Labs' logo • B: Serial number
	<p>Product label (interface boxes) containing:</p> <ul style="list-style-type: none"> • A: Model number • B: Serial number • C: Adaptive Switch Labs' logo • D: Adaptive Switch Labs' contact information
<div style="border: 1px solid black; padding: 5px;"> <p>Contains FCC ID: A8TBM71S2 This device complies with Part 15 of the FCC Rules. Operation is subject to the following 2 conditions: (1) this device must accept any interference received. (2) this device must accept any interferences that may cause undesired operation.</p> </div>	<p>Product label containing:</p> <ul style="list-style-type: none"> • Adaptive Switch Labs' Bluetooth registration • Information about conditions

4 Setup

4.1 General information on setup

The tasks described in this chapter are intended to be performed by trained and authorized service technicians for initial setup. They are not intended to be performed by the user.

4.2 Wiring

For safe and reliable operation, the installation of looms and cables must follow the basic principles of power wiring.

Cables must be secured between their connectors and any point of flexing so that flexing forces are not transferred to the connectors.



CAUTION!

Risk of injury and damage to the remote

Damage to cables increases wiring impedance. A damaged cable can potentially produce localized heat, sparks or arcing and become a source of ignition to surrounding flammable material.

- The installation must ensure that all power cables, including the bus cable, are protected against damage and potential contact with flammable materials.



Risk of damage

- Cables and remote modules can get damaged if not positioned properly.
- Route and position cables and remote modules so that they are free from physical strain, abuse or damage, such as snagging, crushing, impacts from external objects, pinching or abrasion.

Adequate strain relief must be provided for all cables, and the mechanical limits of the cables and looms must not be exceeded.

Ensure that connectors and connector sockets are shielded from water splashes and water ingress. Cables with female connectors should face horizontally or downwards. Ensure all connectors are fully mated.



CAUTION!

Risk of injury and damage to the remote

Connector pins on cables connected to the power module can still be live even when the system is off.

- Cables with live pins should be connected, restrained or covered so that they are not exposed to human contact or materials that could cause electrical shorts.

Make sure that the cables do not extend beyond the wheelchair to prevent them from being caught or damaged by external objects. Take particular care on wheelchairs with movable structures such as a seat lifter.

**WARNING!**

Continuous contact between user and cable can result in frayed cable jacket. This increases risk of electric shorts.

- Avoid routing the cable where it will come into continuous contact with the end user.

When installing the bus cable, avoid undue straining of the cable and connection points. Flexing of the cable should be minimized wherever possible, to extend service life and minimize the risk of accidental damage.

**Risk of damage to bus cable**

Regular bending can damage bus cable

- Use of a cable chain to support the bus cable, where the cable is subject to regular cyclic bending, is recommended. The maximum stretch of the chain should be less than the length of the bus cable. The force applied to flex the cable should never exceed 10 N.



Appropriate life testing should be carried out to determine / confirm the expected service life and inspection and maintenance schedule.

4.3 Connecting the remote

**CAUTION!****Risk of unintended stops**

If the plug of the remote cable is broken, the remote cable may come loose while driving. The remote could suddenly switch off when losing power. This forces an unintended stop.

- Always check the plug of the remote for damage. Contact your provider immediately in case of a damaged plug.

**Risk of damage to the remote**

The remote plug and connector socket fit together in one way only.

- Do not force them together.

1. Lightly push to connect the plug of the remote cable and the connector socket. The plug must lock in place with an audible click.

5 Usage

5.1 Operating the remote

Powering up the remote

1.

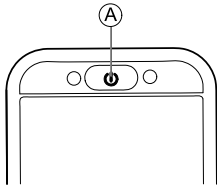

Press ON/OFF key (A).

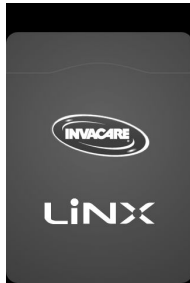

Start screen lights up.

The status LED inside the ON/OFF button lights up green, if no fault is present at power up. After a few seconds display is ready to use.

If there is a fault with the system when powering up, the status LED indicates the fault with a series of red flashes, also a fault icon is displayed in the status bar. For more information about fault indication, refer to *7.1.1 Fault Codes and Diagnosis Codes, page 103*

Powering down the remote

1. Press ON/OFF key (A).

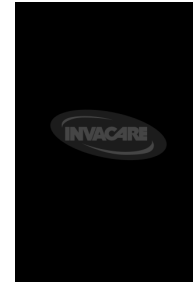

Shut down screen is displayed.

After a few seconds the remote is powered down.

Attendant in charge

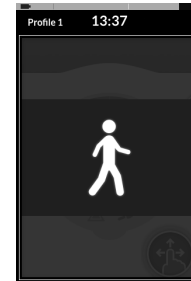

If your wheelchair is fitted with an attendant control (DLX-ACU200) and the attendant control is in charge, an attendant-in-charge-overlay is displayed.

Also the status LED inside the ON/OFF button of the primary remote is turned off.

1. Press ON/OFF button of primary remote to take over control.

Attendant control powers down automatically.





 For more information about using the attendant control, refer to the manual of the attendant control.

5.1.1 Controls on Menu Screen

Buttons

Buttons are used to perform an action, such as  to close the screen.

Currently we use the following buttons on our remotes:

Symbol	Action
	Close screen
	Go back to previous screen
	Open next screen/level. It appears only if a menu entry permit further settings.
	Increase or decrease the value of hour or minute on clock

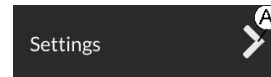



Fig. 5-1 Example of a button

1. Tap on button  to perform the action.

Switches

Switches are used to change between two different states, such as **ON** and **OFF**. The current state is visible on screen.



Fig. 5-2 Example of a switch

1. Tap on switch  to change the state.

Sliders

Sliders are used to change value of a setting continuously.

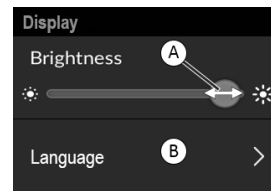



Fig. 5-3 Example of a slider

1. Tap and hold circle  within the slider.
2. Swipe circle to the right to increase the value. Swipe circle to the left to decrease the value.

5.1.2 Settings on Menu Screen

The remote can be configured from Menu screen. Menu screen offers different settings.

Menu Screen

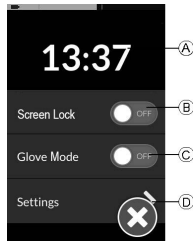

Fig. 5-4

	Entry	Function
Ⓐ	Clock	View and edit time.
Ⓑ	Screen Lock	Activate screen lock.
Ⓒ	Glove Mode	Activate Glove Mode. Touch screen becomes more sensitive, allowing to interact with screen while wearing gloves.
Ⓓ	Settings	Open settings menu

Settings Menu

Settings menu allows you to change settings in three different categories:

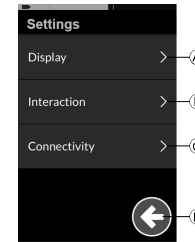

Fig. 5-5

	Entry	Function
Ⓐ	Display	Open display settings
Ⓑ	Interaction	Open interaction settings
Ⓒ	Connectivity	Open connectivity settings
Ⓓ	Back	Go back to the previous level

Display



Fig. 5-6

	Entry	Function
Ⓐ	Brightness	Decrease or increase screen brightness
Ⓑ	Language	Change user interface of Menu screen to selected language

Interaction

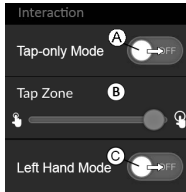



Fig. 5-7

	Entry	Function
Ⓐ	Tap-Only Mode	Toggle between tap mode and swipe-and-tap mode
Ⓑ	Tap Zone	<p>Defines the area used for detecting a tap action on touch screen. It sets the area around the point of initial contact, within a tap is recognized. Outside this area, further, continuous contact will be considered as a drag/swipe.</p> <p>Recommendation:</p> <ul style="list-style-type: none"> • Good dexterity → Low value (small tap zone) • Poor dexterity → High value (large tap zone) <p> This parameter does not change the area around fixed inputs (buttons, links, etc.). It is solely for the area around the first point of contact when tapping or swiping.</p>

	Entry	Function
Ⓒ	Left Hand Mode	<p>Toggle between right-hand and left-hand usage of remote.</p> <p>When the switch is set to ON, all user controls (navigation button, speed slider, lighting controls etc) are displayed and operable from the left-hand side of the screen.</p>

Connectivity

For more information about connectivity settings, see 5.16.1 *Configuring Connectivity Card, page 62.*

5.1.3 Configuring Menu Screen

Opening Menu Screen

1.

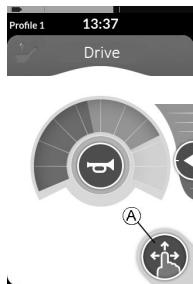

Fig. 5-8

Tap and hold navigation button Ⓐ until Menu screen appears.

Closing Menu Screen

1.

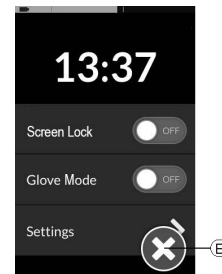

Fig. 5-9

Tap on button Ⓔ to close Menu screen.

Changing Time

1. Tap on clock to edit time.

In Time Edit mode, clock displays time picker where hour and minute values can be changed independently.

2.

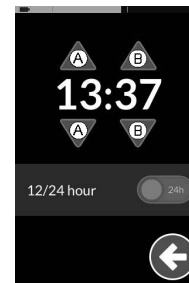

Fig. 5-10

Tap on arrows Ⓐ to adjust hour value or Ⓑ to adjust minute value.

3.

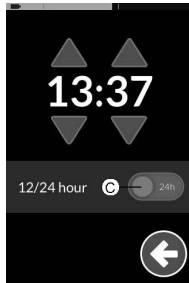



Fig. 5-11

If necessary, tap switch  to toggle between 12- and 24-hour clock.

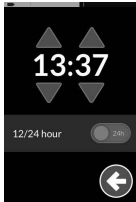

Fig. 5-12 24-hour clock

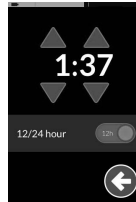

Fig. 5-13 12-hour clock

4.

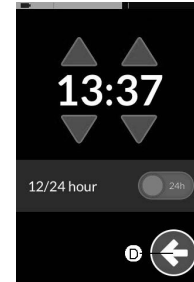



Fig. 5-14

Tap on button  to return to Menu screen.

5.1.4 Locking Screen to Avoid Unintentional Response

The screen lock is a security feature that the user can activate to prevent other people accidentally or intentionally interfering with the touch screen. It also prevents any unintentional response caused by rain or other liquids that may land on the touch screen.

When the screen lock is activated, the screen continues to display normally but it does not respond to any swipe or tap action.

1.

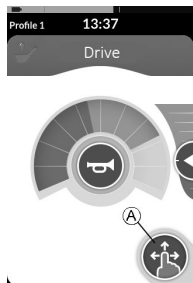

Fig. 5-15

Tap and hold navigation button (A) to open Menu screen.

2.



Fig. 5-16

Tap on Screen Lock switch (A) to lock screen.

3.

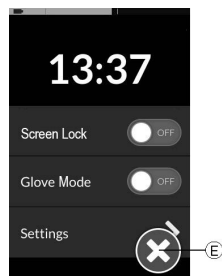

Fig. 5-17

Tap on button (E) to close Menu screen.

Screen lock is activated.



Turn remote off and on (power-cycle) to deactivate screen lock.



Keep the touch screen dry to ensure proper response during use.

5.2 Navigating through user function cards

How to navigate through user function cards depends on how the navigation button is configured. Refer to 3.3 *Navigation button*, page 15, for more information about the possible configurations.

You can locate and select a function card by navigating through the programmed profiles and functions. There are a number of navigation methods that can be used, depending on your needs and abilities. These methods fall into two groups:

- direct navigation and
- indirect navigation.

5.2.1 Function Change Inhibits

Function change blocked is a safety feature that prevents accidental driving or seating movements, when:

- a function change should be carried out during the user performs an action on the active function.



Fig. 5-18

The user must finish his current action to change the function. Otherwise a function change blocked overlay is displayed.

5.2.2 Using direct navigation

You navigate profiles and functions by moving from an active function card to an adjacent function card. The function card becomes active immediately.

 Direct navigation is not performed with an active user input (e.g. remote), since the active user input is used to operate the active function card only (e.g. moving the remote to drive). Instead, the user navigates through the profiles and functions using the touch screen or other control inputs.

Using swipe-and-tap mode

Changing function cards

- 

Swipe over screen or tap navigation button to open card preview display.
- 

Swipe left or right to change function cards.
- Tap on selected function card, tap navigation button or wait for a few seconds to activate selected function card.

Changing profiles

- 

Profile 1



Profile 2



Profile 3

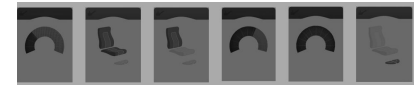

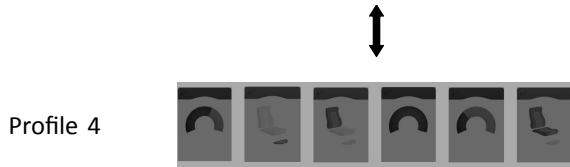

Swipe up or down to activate another profile.
The screen view focuses on the first function card or the last-used function card in the profile, depending on how the programming is set up.

2. Swipe left or right to change function cards.
3. Tap on selected function card, tap navigation button or wait for a few seconds to activate selected function card.

Using tap mode

Changing function cards



Tap on navigation button (short press) to open card preview display.



Tap to left or right of card that is in the middle of display to change function cards.

3. Tap on selected function card, tap navigation button or wait for a few seconds to activate selected function card.

Changing profiles

- 1.
- 30

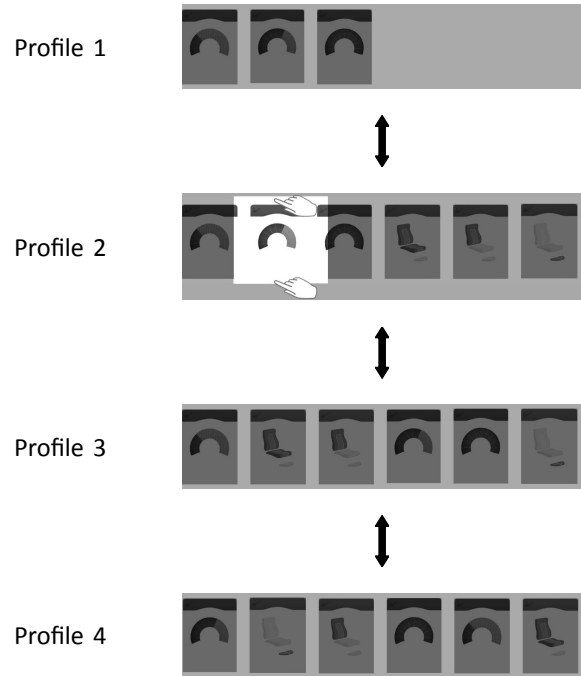

Tap above or below function card that is in the middle of display to activate another profile.

The screen view focuses on the first function card or the last-used function card in the profile depending on how the programming is set up.

2. Tap on navigation button or wait for a few seconds to activate selected function card.

Using control input (CI)

A control input can be any external switch, for example, an egg switch or a lip switch at a Sip and Puff Array.

1. Short press to change function card.
2. Long press to change profile.

5.2.3 Using indirect navigation

Indirect navigation is the ability to navigate through different profiles and function cards, independently from the touch display, with the help of the active user input (for example, a head array).

By default, the indirect navigation is disabled. Contact your provider, if indirect navigation should be enabled.

Similar to the drive function, there is a difference between a three-quadrant (3Q) and a four-quadrant (4Q) operation.

User input type	Mapping for menu select	Mapping for scan select
4Q: <ul style="list-style-type: none"> • joystick • Sip and Puff • Sip and Puff Head Array 	left input: previous menu right input: select reverse input: next item in menu forward input: previous item in menu	left input: select right input: select reverse input: select forward input: select
3Q: <ul style="list-style-type: none"> • Head Array • Four Switch Proximity Array 	left input: select right input: next item in menu reverse input: disabled forward input (Four Switch Proximity Array only): disabled	left input: select right input: select reverse input: disabled forward input (Four Switch Proximity Array only): disabled

5.2.4 Menu select

With menu select, you perform both, the navigation and the function card selection.

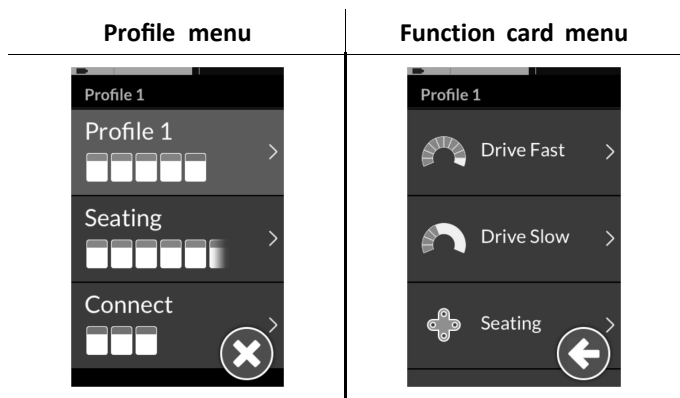

To navigate the menus with menu select, you select a profile from the profile menu and then select a function card from the function card menu. Before making a selection, you are free to move within the menus and free to move between the menus (profile to function card and vice versa) as necessary.

Navigation entry

By default the indirect navigation is started via an external switch, for example, an egg switch.

The indirect navigation can be started without an external switch, via **Stand by select**, which must be enabled by your provider. This means that the indirect navigation starts

automatically after a period of time without user activity. This period can be set by your provider.

There are two different ways, the indirect navigation is entered:

- If the Navigation entry is set to **First Profile**, the menu selection starts at the first profile in the profile menu. You select a profile, before moving into the selected profile's function card menu. You can then either select a function card from the function card menu or return to the profile menu to select a different profile.
- If Navigation entry is set to **Active User Function**, the menu selection starts at the currently selected function card in the function card menu. From here you can choose to navigate the function card menu, select a function card or move up into the profile menu and select a different profile.

Menu select with 4Q operation

1. Press external switch.
Profile menu opens.

2.

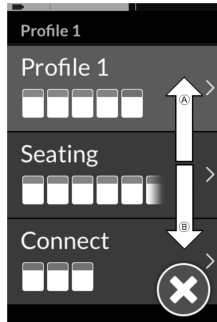

Give forward input **A** or reverse input **B** to switch between profiles.

3.

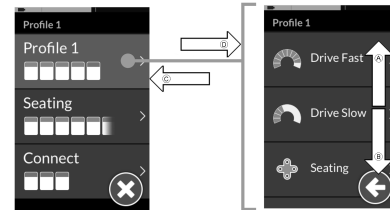

Give right input **D** to select profile.

Function card menu opens.

Give forward input **A** or reverse input **B** to switch between function cards.

Give left input **C** to switch back to previous menu.

4.

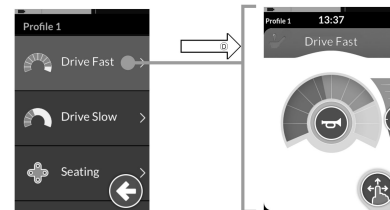

Give right input **D** to select function card.

Menu select with 3Q operation

1. Press external switch.
Next function card is displayed.
2. Press external switch again to switch through all function cards in the profile.
As soon as all function cards are switched through, profile menu opens.

3.

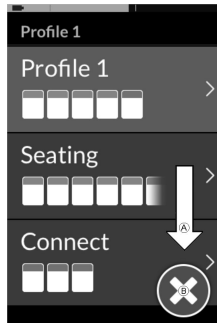

Give right input Ⓐ to change profile.

4. To close profile menu, give right input until Close button Ⓑ is selected.

Give left input to close profile menu.

5.

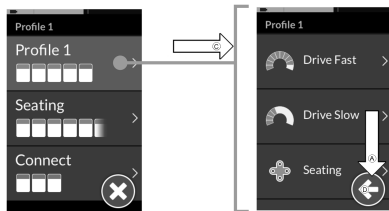

Give left input Ⓒ to select profile.

Give right input Ⓐ to change function card.

6. To go back to profile menu, give right input until Back button Ⓓ is selected.

Give left input to go back to profile menu.

7.

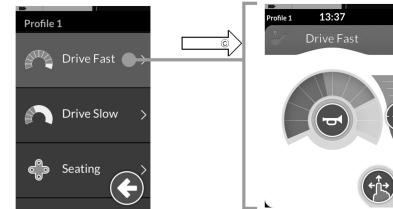

Give left input Ⓒ to select function card.

5.2.5 Overview scan select

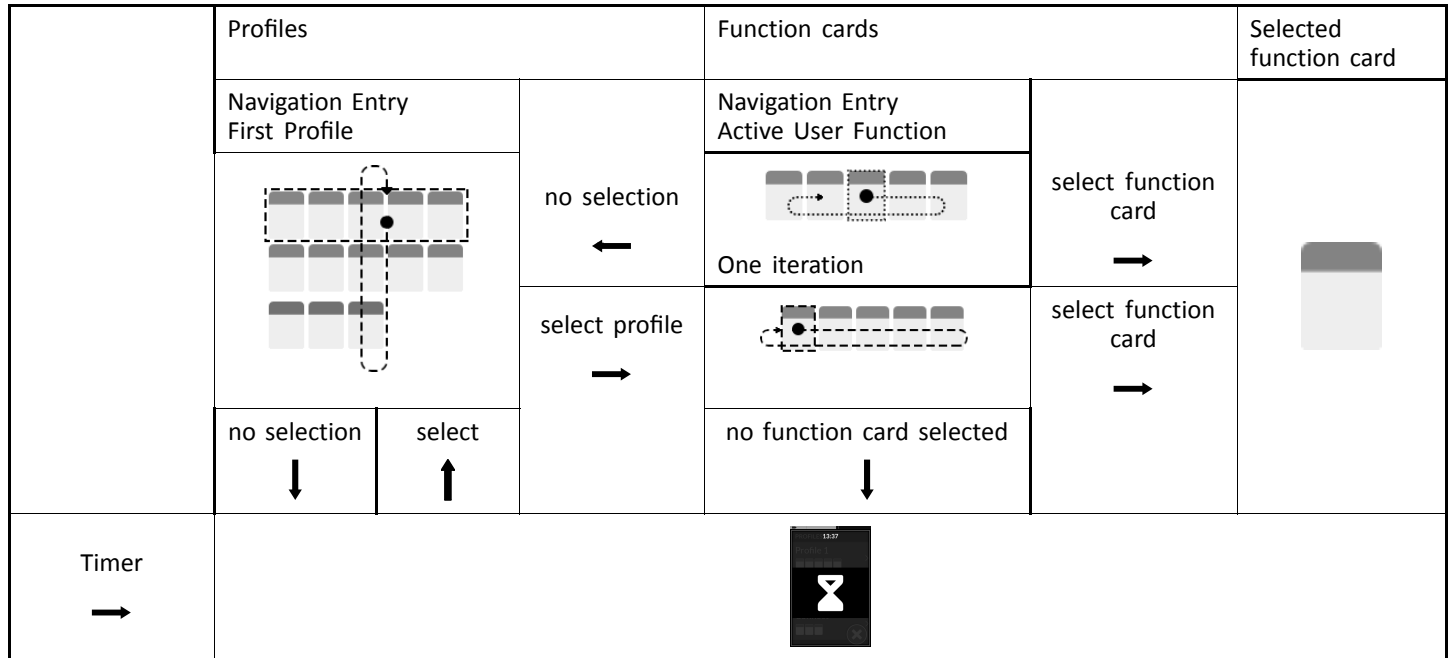

5.2.6 Scan select

With scan select, the system performs the navigation and you select the function card. Scan select provides you with a semi-automated process for navigating through the profiles and function card menus by displaying you one menu item (or navigation control) at a time.

For each menu item displayed, you can choose to select it or ignore it. If ignored, the next menu item is displayed on

the touch screen after a small period of time. The period is set by the provider.

Function card menu

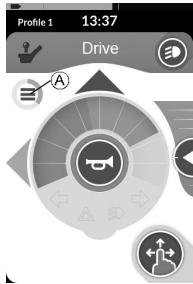

The period of time before the next item is displayed, is shown by an indicator ring **A** or an indicator bar **B**.

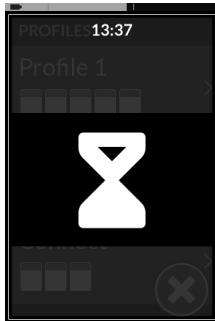

Each menu is iterated a set number of times. This number is set by your provider. If no selection is made when the set number of iterations is reached, the system enters an idle state, displayed by the overlay above.

The system can enter the idle state from either the profile menu or the function card menu. To exit the idle state, you

Profile menu

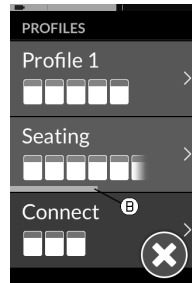

must provide a select command. The profile menu is always entered when exiting the idle state.

Navigation entry

By default the indirect navigation is started via an external switch, for example, an egg switch.

If **Stand by select** is enabled by your provider, the indirect navigation starts automatically after a period of time without user activity. This period can be set by your provider.

There are two different ways, the indirect navigation is entered, refer to *5.2.5 Overview scan select, page 35* for a detailed graphic:

- If Navigation entry is set to **First Profile**, the first item in the profile menu is displayed on the touch screen. If this item is not selected, the system iterates through the profile menu until a profile is selected or until the number of iterations is reached, at which point the menu displays the idle state. If a profile is selected before the system goes into the idle state, the system displays the first item in the function card menu. If this item is not selected, the system iterates through the function card menu until a function card is selected or until the number of iterations is reached, at which point the menu displays the idle state.

- If Navigation entry is set to **Active User Function**, the currently selected function card item is displayed on the touch screen. If this function card is not selected, the system iterates once through the remaining function card items in the profile, wrapping around from the last menu item to the first, if necessary. During this single iteration, a function card must be selected, otherwise the menu reverts to the profile menu. If the system reverts to the profile menu, the first item in the profile menu is displayed on the touch screen. If this item is not selected, the system iterates through the profile menu until a profile is selected or until the number of iterations is reached, at which point the menu displays the idle state. If a profile is selected before the system goes into idle state, the system displays the first item in the function card menu. If this item is not selected, the system iterates through the function card menu until a function is selected or until the number of iterations is reached, at which point the menu displays the idle state.

Scan select with 4Q or 3Q operation

User input type	Mapping for scan select
4Q: <ul style="list-style-type: none"> joystick Sip and Puff Sip and Puff Head Array 	left input: select right input: select reverse input: select forward input: select
3Q: <ul style="list-style-type: none"> Head Array Four Switch Proximity Array 	left input: select right input: select reverse input: disabled forward input (Four Switch Proximity Array only): disabled

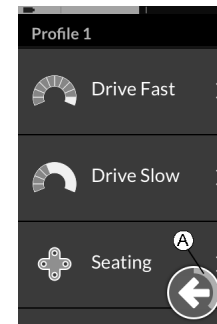

Like in menu select, it is possible, to go back from function card menu to profile menu or close the profile menu. The control navigation items are displayed in the scanning

process. The duration of time before the next item is displayed, is shown by an indicator ring.

1. Give select input, if control navigation item Ⓐ is displayed.

5.3 Using the multipurpose buttons

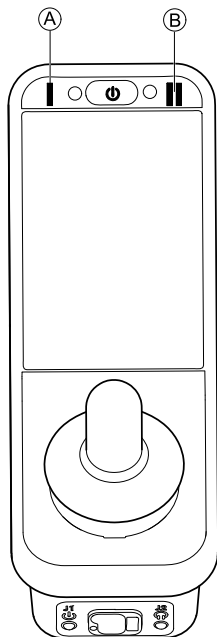

By default, you can change profiles and function cards with the multipurpose buttons.

1. Press left button Ⓐ to switch to next profile.
2. Press right button Ⓑ to switch to next function card.

5.4 Using the Toggle Switches (Optional)

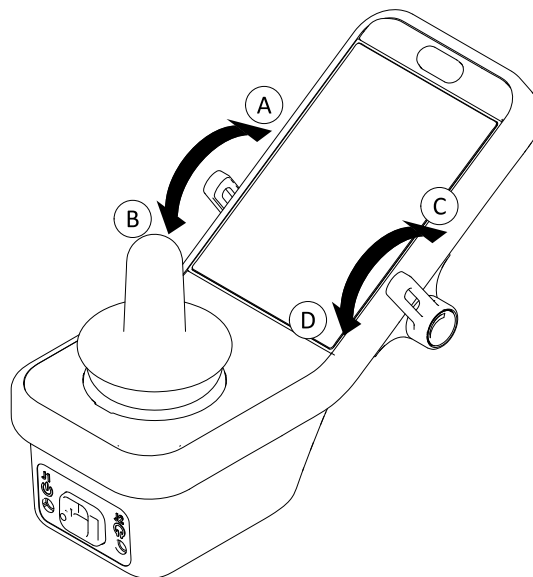

Fig. 5-19

The toggle switches are an alternative means to switch commonly-used controls and can be an option for users who, for example have difficulties to reach the ON/OFF key, multipurpose buttons or struggle to operate certain areas of the touch screen of the remote.

When the switches are deflected forwards or backwards from the neutral position, the programmed action is performed. If the switches are released, the switches return to the neutral position.

By default, the following actions are performed:

A	Left toggle switch	Forward command	Power button (On / Off)
B		Backwards command (short press)	switch to next function card
		Backwards command (long press)	Switch to next profile
C	Right toggle switch	Forward command	Increase speed by 10 %
D		Backwards command	Decrease speed by 10 %

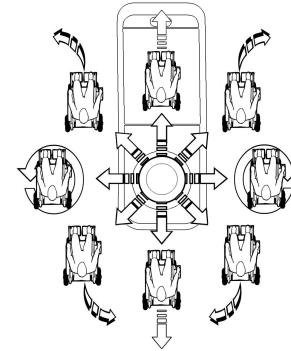

The speed of the wheelchair is proportional to the joystick deflections, so that the further the joystick is moved from the neutral position, the faster the wheelchair travels.

5.5 Proportional driving mode

5.5.1 Using the joystick

The joystick controls the direction and speed of the wheelchair.

When the joystick is deflected from the center (neutral) position, the wheelchair moves in the direction of the joystick movement.

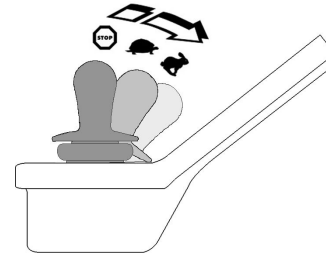

If the joystick is moved back to the neutral position, the wheelchair slows down and stops.

If the joystick is released from any position other than the neutral position, the joystick returns to the neutral position and the wheelchair slows down and stops.

The joystick can also be used to wake up the system when in sleep mode, if this parameter has been enabled by the provider. Refer to 5.14 *The sleep mode*, page 53.

5.5.2 Controlling the maximum speed

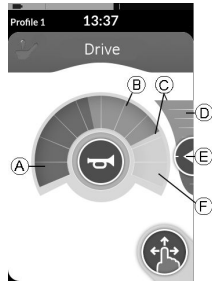

The speedometer is divided into ten segments, representing the speed range of the wheelchair. Each segment can be displayed in one of three colors.

- The green section ① displays the speed range, determined by the set point ⑤ on the speed slider ④.
- The yellow section ② displays the pre-set maximum speed range ③, depending on the programming of the drive card.
- The grey section ⑥ displays that the total maximum speed range of the wheelchair is not reached in the depending drive function.

In each drive card you are able to control the pre-set maximum speed depending on your needs.

1.

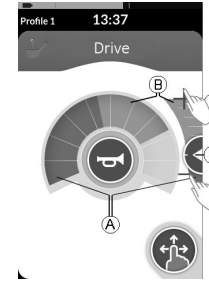

Swipe-and-tap mode	Tap mode
Slide set point ⑤ up or down, when in Swipe-and-tap mode.	Tap at top or at button of speed slider ④, when in Tap mode. Plus and minus symbols indicate where to tap.

The proportion of the green sections ① and yellow sections ② on the speedometer and the speed slider correspond to the position of the set point ⑤.

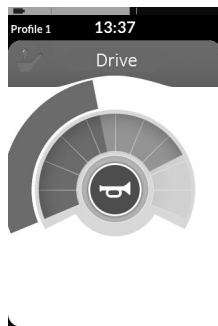

As soon as you start driving, speed slider and navigation button disappear from the display. The current speed is displayed by a green ring around the speedometer.

5.6 Latched driving mode

Latched driving modes allow you to latch (or maintain) a forward or reverse speed so that you can drive without continuously providing a drive demand.



Risk of unintended movement

When you make a forward or reverse demand, the wheelchair drives forwards or reverse at a constant speed and will continue driving at that constant speed until one of the following occurs:

- the external stop switch is pressed (refer to *5.6.1 External stop switch, page 42*),
- the emergency stop is performed (refer to *5.7 Emergency stop, page 47*),
- an opposite demand is received (a reverse demand when driving forwards or a forward demand when driving reverse) or
- the Latch Drive Timeout has expired.



To avoid potentially dangerous situations Invacare recommends to make yourself familiar with the latched driving mode, especially with the demands to stop the wheelchair.







The term demand, mentioned in this manual, means the input depending on the type of control, e.g. joystick movements or sip and puff demands. Refer to *5.17.7 Using the Sip-N-Puff Head Array, page 89* for more information about the Sip and Puff Head Array.



By default, latched driving mode is pre-set in combination with a Sip and Puff only and with a Sip and Puff Head Array. For all other types of control, latched driving mode is not a default set-up but can be enabled by your provider.





Each drive function can be assigned with a latched driving mode by your provider. There are six latched driving modes, which are indicated on the lower left of the drive card with the symbols displayed in the table below.

-  1 Step Up
-  3 Step Up
-  5 Step Up
-  3 Step Up/Down

 5 Step Up/Down

 Cruise Control

 The Latch Drive Timeout period is restarted whenever a subsequent drive demand is given.

 The Latch Drive Timeout is set by the provider. To change the parameter, contact your provider.

Turn demands

The wheelchair can be steered while in latched driving mode. If a turn demand is given, the wheelchair remains in latched driving mode and also responds to the turn demand for the duration that the turn demand is given. The Latch Drive Timeout period is restarted whenever a turn demand is given. When the Latch Drive Timeout expires, the wheelchairs stops.

5.6.1 External stop switch

To set up a wheelchair for latched driving, an external stop switch must be fitted to the wheelchair. Ideally, the external stop switch should be highly visible and easily accessible to provide an extra level of safety and security for the user.

External stop switch test

The external stop switch test checks that the external stop switch is functioning correctly. The test is conducted once per power cycle when:

- the wheelchair is powered up in a latched drive mode function or
- a latched drive mode function is selected following a non-latched mode function.



The external stop switch test is indicated by a screen overlay.

1. Press external stop switch to complete test.



The wheelchair does not drive until the external stop switch test is completed successfully.

5.6.2 1 Step Up

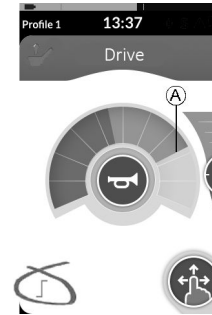

In this mode, a single drive demand (forward or reverse) causes the wheelchair speed to accelerate to the maximum drive speed **A** of the selected drive card and then remain at that speed for the programmed Latch Drive Timeout period as long as no further demand is given.

Driving

1. Give drive demand in desired direction (forward or reverse).
2. Release drive demand.
Wheelchair speed accelerates to maximum drive speed of the selected drive card.

Stopping

- Give drive demand in opposite direction (a reverse demand when driving forwards or a forward demand when driving in reverse),
- press external stop switch,
- perform emergency stop or
- let Latch Drive Timeout expire.

5.6.3 3 Step Up

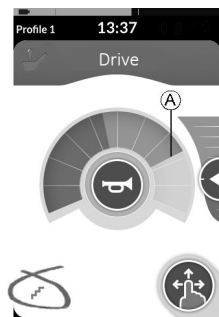

In this mode, you can step through one of three fixed speeds. The speeds available are 33 %, 67 % and 100 % of the maximum pre-set reverse or forward speed ^(A) of the selected drive card and then remain at that speed for the programmed Latch Drive Timeout period as long as no further demand is given.

Driving

1. Give drive demand in desired direction (forward or reverse).
2. Release drive demand.
Wheelchair speed accelerates to 33 % of the maximum drive speed.
3. Give forward demand when driving forwards or reverse demand when driving in reverse to accelerate to next fixed speed.
4. Release drive demand.
New speed is held constantly.

Stopping

- Give drive demand in opposite direction (a reverse demand when driving forwards or a forward demand when driving in reverse),
- press external stop switch,
- perform emergency stop or
- let Latch Drive Timeout expire.

5.6.4 5 Step Up

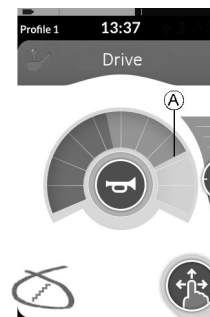

In this mode, you can step through one of five fixed speeds. The speeds available are 20 %, 40 %, 60 %, 80 % and 100 % of the maximum pre-set reverse or forward speed ^(A) of the selected drive card and then remain at that speed for the programmed Latch Drive Timeout period as long as no further demand is given.

Driving

1. Give drive demand in desired direction (forward or reverse).
2. Release drive demand.
Wheelchair speed accelerates to 20 % of the maximum drive speed.
3. Give forward demand when driving forwards or reverse demand when driving in reverse to accelerate to next fixed speed.
4. Release drive demand.
New speed is held constantly.

Stopping

- Give drive demand in opposite direction (a reverse demand when driving forwards or a forward demand when driving in reverse),
- press external stop switch,
- perform emergency stop or
- let Latch Drive Timeout expire.

5.6.5 3 Step Up/Down

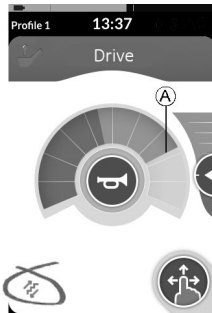

In this mode, you can step up or down through one of three fixed speeds. The speeds available are 33 %, 67 % and 100 % of the maximum pre-set reverse or forward speed **A** of the selected drive card and then remain at that speed for the programmed Latch Drive Timeout period as long as no further demand is given.

Driving

1. Give drive demand in desired direction (forward or reverse).
2. Release drive demand.
Wheelchair speed accelerates to 33 % of the maximum drive speed.
3. Give forward demand when driving forwards or reverse demand when driving in reverse to accelerate to next fixed higher speed.
Give reverse demand when driving forwards or forward demand when driving in reverse to decelerate to next fixed lower speed.



Drive demand in opposite direction must be quick, less than one second, otherwise wheelchair stops.

4. Release drive demand.
New speed is held constantly.

Stopping

- Give drive demand longer than one second in opposite direction (a reverse demand when driving forwards or a forward demand when driving in reverse),
- press external stop switch,
- perform emergency stop or

- let Latch Drive Timeout expire.

5.6.6 5 Step Up/Down



In this mode, you can step up or down through one of five fixed speeds. The speeds available are 20 %, 40 %, 60 %, 80 % and 100 % of the maximum pre-set reverse or forward speed **A** of the selected drive card and then remain at that speed for the programmed Latch Drive Timeout period as long as no further demand is given.

Driving

1. Give drive demand in desired direction (forward or reverse).
2. Release drive demand.
Wheelchair speed accelerates to 20 % of the maximum drive speed.

3. Give forward demand when driving forwards or reverse demand when driving in reverse to accelerate to next fixed higher speed.

Give reverse demand when driving forwards or forward demand when driving in reverse to decelerate to next fixed lower speed.

- Drive demand in opposite direction must be quick, less than one second, otherwise wheelchair stops.

4. Release drive demand.
New speed is held constantly.

Stopping

- Give drive demand longer than one second in opposite direction (a reverse demand when driving forwards or a forward demand when driving in reverse),
- press external stop switch,
- perform emergency stop or
- let Latch Drive Timeout expire.

5.6.7 Cruise Control

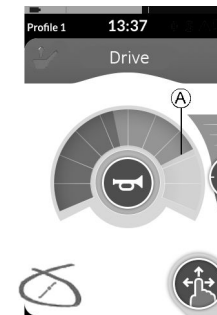

In this mode, you do not have fixed steps and can choose the latched speed by yourself and then remain at that speed for the programmed Latch Drive Timeout period as long as no further demand is given.

Driving

1. Give and hold drive demand in direction (forward or reverse) until wheelchair accelerates to desired speed.
2. Release drive demand.
Wheelchair speed is held constantly.
3. If maximum drive speed **(A)** is not reached, give and hold drive demand again in same direction.
4. Release drive demand.
New speed is held constantly.
5. Give drive demand in opposite direction (reverse when driving forwards or forward when driving in reverse) to decelerate speed.
6. Release drive demand.
New speed is held constantly.



Stopping

- Give drive demand two times in same direction quickly (less than one second),
- press external stop switch,
- perform emergency stop or
- let Latch Drive Timeout expire.

5.7 Emergency stop

If you press the ON/OFF button while driving, an emergency stop is carried out. The remote powers down after this.

5.8 Operating the position lights

-  If you drive outside, turn on the position lights under bad visibility conditions or darkness.
-  To operate the position lights, you need to stop the mobility device.

Turn on position lights

1.



Tap Lighting control button **(A)**.

2.

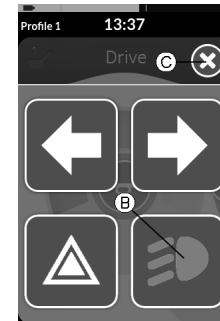

Lighting button panel overlays screen.
Tap Position lights symbol **B**.



Position lights turn on. Position lights telltale becomes illuminated in the lighting dashboard.

3. Tap button **C** to close Lighting button panel.



If you start driving, the Lighting button panel overlay disappears automatically and the position lights remain turned on.

Turn off position lights

- 1.



Tap Lighting control button **A**.

- 2.

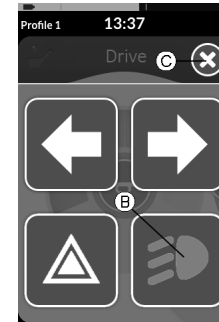

Lighting button panel overlays screen.

Tap Light symbol **B**.

Position lights turn off.

3. Tap button **C** to close Lighting button panel.



If you start driving, the Lighting button panel overlay disappears automatically.

5.9 Operating the hazard lights

 To operate the hazard lights, you need to stop the mobility device.

Turn on hazard lights

1.



Tap Lighting control button **A**.

2.

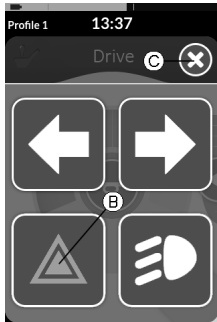

Lighting button panel overlays screen.
Tap Hazard lights symbol **B**.



Hazard lights turn on. Hazard lights telltale becomes illuminated in the lighting dashboard.

3. Tap button **C** to close Lighting button panel.



If you start driving, the Lighting button panel overlay disappears automatically and the hazard lights remain turned on.

Turn off hazard lights

1.



Tap Lighting control button (A).

2.

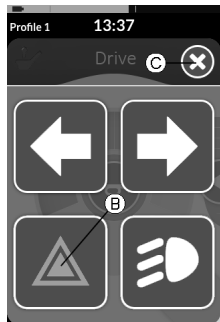

Lighting button panel overlays screen.

Tap Hazard lights symbol (B).

Hazard lights turn off.



If you start driving, the Lighting button panel overlay disappears automatically.

5.10 Operating the direction indicators



To operate the direction indicators, you need to stop the mobility device.

Turn on direction indicators

1.



Tap Lighting control button (A).

2.

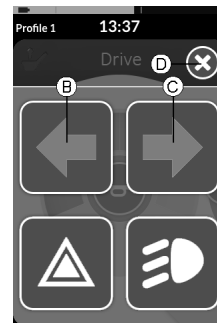



Lighting button panel overlays screen.

Tap left direction indicator symbol (B) or right direction indicator symbol (C).



Either left or right direction indicator turns on. Left or right indicator telltale becomes illuminated in the lighting dashboard.

3. Tap button **D** to close Lighting button panel.

-  If you start driving, the Lighting button panel overlay disappears automatically.
-  After more than ten seconds, the direction indicators turn off automatically.

Turn off direction indicators

- 1.



Tap Lighting control button **A**.

- 2.

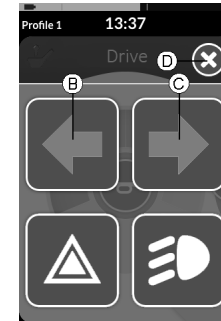

Lighting button panel overlays screen.

Tap left direction indicator symbol **B** or right direction indicator symbol **C**.

Either left or right direction indicator turns off.

-  If you start driving, the Lighting button panel overlay disappears automatically.

5.11 Operating the horn

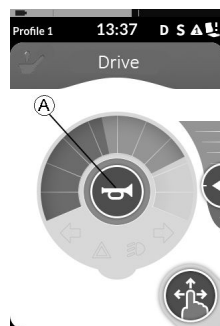

1. Tap horn button **A** to sound horn.
Horn sounds as long as button is tapped.

5.12 Operating Lighting Functions and Horn via Utility Function Card

Via a utility function card you are able to operate the lighting functions and horn with an external input. The utility function card is part of one or more profiles and can be activated like a drive or seating function card.

1. Activate utility function card.
2. Give demand according following list.



Fig. 5-20

- Give forward demand **A** to sound horn.
- Give short demand to right **B** to turn on/off position lights.
- Give short demand to left **C** to turn on/off hazard lights.
- Give long demand to left or right **D** to turn on left or right direction indicator. A short demand can be used to turn them off.

 Direction indicators turn off automatically after ten seconds.

 Activate a drive function card to drive normally, while position lights and hazard lights remain turned on.

5.13 Locking/unlocking the remote

By default, lock function is disabled. Contact your provider to change the configuration.

If function is enabled, the system can be locked / unlocked using below described sequence.

Locking the remote

1.



Fig. 5-21

Press ON/OFF button for more than three seconds, until a locking overlay is displayed.

2. Remote powers down.

When powering up remote, locking overlay is displayed.

Unlocking the remote

1. Press ON/OFF button.

2.

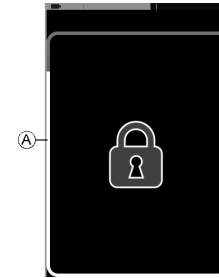

Fig. 5-22

Tap on locked display until white frame around locking screen **A** is filled.

3. Touch display is unlocked and can be used again.



If you do not apply the unlock sequence or the ON/OFF button is pressed again before the unlock sequence is complete, the system returns to the locked state and powers down.

5.14 The sleep mode

The sleep mode is no factory setting, but can be enabled by your provider. If this parameter is set ON, the system goes into sleep mode after a period of time without user activity. This period can be set by the provider.

Before a system goes into sleep mode, the system enters a transition period. During the transition period, the touch display and all indicators slowly dim until they are switched off.

During this transition period sleep mode can be interrupted by performing any input by moving the joystick, pressing the ON/OFF button or tapping on the touch display.

To wake the system from sleep mode, move the joystick or either press the ON/OFF button, if this parameter has been enabled by your provider.

5.15 Operating powered seating functions

Powered seating functions, such as powered elevating legrests or powered recline, are carried out as described below.

5.15.1 Through Seating Cards



Fig. 5-23

By default, every seating card displays a single powered seating function. Different configurations are listed below. Contact your provider to change the configuration.

Choose the seating card with the seating function you want to operate, see 5.2 *Navigating through user function cards, page 28.*

1.



Fig. 5-24

Give forward or reverse demand to operate seating function.

When a motion becomes active, navigation button disappears (A), the active direction of the motion (B) is displayed, the other becomes inactive (C) and drive inhibit/lockout icon (D) is displayed in the status bar. Motion is deactivated as soon as demand is released or when motion reaches its end-of-travel.

Displayed Symbols And Their Meanings



Powered seat tilt



Powered recline



Seat lifter



Left or center-mount powered elevating legrest



Right powered elevating legrest



Both powered elevating legrests



Powered recline and powered elevating legrests

Other Configurations



The displayed function cards are configuration examples only.

- **Four quadrant configuration**

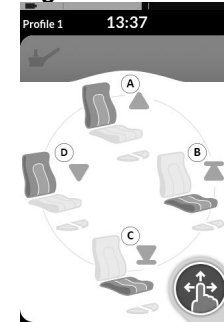

Fig. 5-25

- Ⓐ Powered recline up
- Ⓑ Seat lifter up
- Ⓒ Seat lifter down
- Ⓓ Powered recline down

All four quadrants are used for operating powered seating functions.

1. Give and hold forward Ⓐ, reverse Ⓒ, left Ⓓ or right demand Ⓑ to operate seating function. Motion is deactivated as soon as demand is released or when motion reaches its end-of-travel.

- **Latched configuration**

A latched configuration allows you to operate a motion without continuously providing a demand.

A latched configuration can be a single powered seating function or a four quadrant configuration.



Fig. 5-26

1. Give demand to front or rear to operate seating function.
2. Release demand.
Motion is deactivated as soon as joystick is deflected again or when motion reaches its end-of-travel.

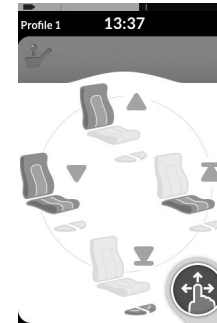

Fig. 5-27

In a four quadrant configuration it is possible to mix the motion operations, like displayed in the example.

5.15.2 Through External Switches



Not all configurations and combinations of powered seating functions through external switches are available on all products.

With an external switch, seating functions can be controlled while driving and without using seating cards.

When the seating function is activated without a seating card, a small overlay is displayed on the touch display, to inform the user, that the seating is being controlled externally. The overlay remains on the touch display for the duration of the seating operation.



Powered recline



Seat lifter



Left or center-mount powered elevating legrest



Right powered elevating legrest



Both powered elevating legrests



Powered seat tilt



Powered recline and powered elevating legrests

Stereo toggle switch

The stereo toggle switch alternates powered seating functions of the following single power configurations:

- Powered recline only

- Powered seat tilt only
- Center-mount elevating legrest (LNX) only

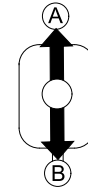

Fig. 5-28

1. Make sure mobility device is on level surface and turned on.
2. Deflect and hold toggle switch up **A** or down **B** to move particular seating function. Seating function moves as long as toggle switch is deflected.

Stereo button switch

The stereo button switch alternates powered seating functions of the following single power configurations:

- Powered recline only
- Powered seat tilt only
- Center-mount elevating legrest (LNX) only

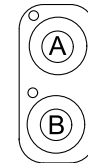

Fig. 5-29

1. Make sure mobility device is on level surface and turned on.
2. Press and hold stereo buttons Ⓐ or Ⓑ to move particular seating function.
Seating function moves as long as button is pressed.

4-way toggle switch

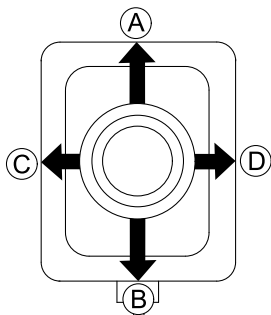

Fig. 5-30

1. Make sure mobility device is on level surface and turned on.
2. Deflect and hold toggle switch to direction, that moves particular seating function.
Seating function moves as long as toggle switch is deflected.

See tables below for combinations of directions and powered seating functions.



The tables shows the factory settings. For reprogramming, contact your provider.

Powered seat tilt and Powered recline

- | | |
|-------------|------------------------|
| Ⓐ (Forward) | Powered seat tilt up |
| Ⓑ (Reverse) | Powered seat tilt down |
| Ⓒ (Left) | Powered recline up |
| Ⓓ (Right) | Powered recline down |

Powered seat tilt and LNX legrest

- | | |
|-------------|------------------------|
| Ⓐ (Forward) | Powered seat tilt up |
| Ⓑ (Reverse) | Powered seat tilt down |
| Ⓒ (Left) | LNX up |
| Ⓓ (Right) | LNX down |

Powered recline and LNX legrest

- | | |
|-------------|------------------------------|
| Ⓐ (Forward) | Powered recline and LNX up |
| Ⓑ (Reverse) | Powered recline and LNX down |
| Ⓒ (Left) | LNX up |
| Ⓓ (Right) | LNX down |

Powered seat tilt and seat lifter

- | | |
|-------------|------------------------|
| Ⓐ (Forward) | Powered seat tilt up |
| Ⓑ (Reverse) | Powered seat tilt down |
| Ⓒ (Left) | Seat lifter up |
| Ⓓ (Right) | Seat lifter down |

Dual powered elevating legrests

- Ⓐ (Forward) Left powered elevating legrest up
- Ⓑ (Reverse) Left powered elevating legrest down
- Ⓒ (Left) Right powered elevating legrest up
- Ⓓ (Right) Right powered elevating legrest down

4-way button switch

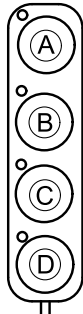

Fig. 5-31

1. Make sure mobility device is on level surface and turned on.
2. Press and hold button to move particular seating function.
Seating function moves as long as button is pressed.
See tables below for combination of buttons and powered seating functions.



The tables shows the factory settings. For reprogramming, contact your provider.

Powered seat tilt and Powered recline

- Ⓐ Powered seat tilt up
- Ⓑ Powered seat tilt down
- Ⓒ Powered recline up
- Ⓓ Powered recline down

Powered seat tilt and LNX legrest

- Ⓐ Powered seat tilt up
- Ⓑ Powered seat tilt down
- Ⓒ LNX up
- Ⓓ LNX down

Powered recline and LNX legrest

- Ⓐ Powered recline and LNX up
- Ⓑ Powered recline and LNX down
- Ⓒ LNX up
- Ⓓ LNX down

Powered seat tilt and seat lifter

- Ⓐ Powered seat tilt up
- Ⓑ Powered seat tilt down
- Ⓒ Seat lifter up
- Ⓓ Seat lifter down

Dual powered elevating legrests

- (A) Left powered elevating legrest up
- (B) Left powered elevating legrest down
- (C) Right powered elevating legrest up
- (D) Right powered elevating legrest down

10-way switch

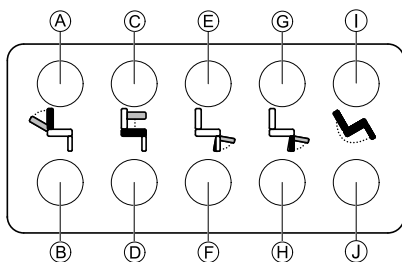

Fig. 5-32

1. Make sure mobility device is on level surface and turned on.
2. Press and hold button to move particular seating function. Seating function moves as long as button is pressed.

The lower row of buttons move the seating function to its home position, see table below for details.

- (A) Powered recline down
- (B) Powered recline up
- (C) Seat lifter up

- (D) Seat lifter down
- (E) Left or center-mount powered elevating legrest up
- (F) Left or center-mount powered elevating legrest down
- (G) Right powered elevating legrest up
- (H) Right powered elevating legrest down
- (I) Powered seat tilt up
- (J) Powered seat tilt down

5.15.3 Speed Reduction and Seating Function Inhibits



The mentioned speed reduction and seating function inhibits do not apply to all Invacare wheelchair models.

Driving function inhibits

- **Drive lockout**

Drive lockout (DLO) is a function to prevent the wheelchair from being driven when the seat tilt or recline are beyond a pre-determined safe total angle. The total angle can be any combination of seat angle, recline and/or surface angle. Drive lockout only respond when you adjust angles in standstill.



According to that, above icon is displayed in the status bar. This indicator remains active until Drive lockout is deactivated by adjusting seat angle and backrest angle.

- **Speed reduction**

If the seat lifter or the seat angle has been adjusted above a certain point, the drive electronics considerably reduces the speed of the wheelchair. If speed reduction has been activated, drive mode can only be used to carry out movements in reduced speed and not for regular driving. To drive normally, adjust the lifter or the seat angle until the speed reduction is deactivated again.



Speed reduction is shown in the display. If the seat lifter or the seat angle is raised above a certain point, the above icon is displayed in the status bar. This indicator remains active until speed reduction is deactivated again by lowering the lifter.

Seating function inhibits

- **Tilt limit**



Fig. 5-33

The maximum tilt limit switch is a function to prevent the seat tilt or recline from extending beyond a maximum pre-set angle, when the seat lifter is raised above a certain point. The drive electronics stops automatically, a grey exclamation point is displayed on the seating card and tilting or reclining backwards is inhibited (A).



According to that, an icon with a seat and an exclamation point is displayed in the status bar. This indicator remains active until the tilt limit is deactivated by lowering the lifter.

- **Lifter seat lockout**



Fig. 5-34

The drive electronics is equipped with a sensor to prevent the seat lifter from rising up above a certain point when the seat tilt or recline is adjusted above a certain point. The drive electronics stops automatically, a grey exclamation point is displayed on the seating card and extend is inhibited (A).



According to that, an icon with a seat and an exclamation point is displayed in the status bar. This indicator remains active until the lifter seat lockout is deactivated by moving seat tilt or recline up.

5.16 Connectivity Cards

Connectivity cards allow you to communicate with external devices. Connectivity functions supported by your remote are a mouse mover and a switch control. By default, these functions are disabled. Contact your provider to activate Connectivity Cards.

The mouse mover function allows you to control the cursor on a PC or laptop's screen with a user input on the wheelchair, such as the joystick on the remote module or external joysticks. At the moment a four-quadrant operation is needed to use the mouse mover.

The switch control function is an accessibility feature that allows you to navigate and select items on your mobile device (Android and iOS) using the remote's joystick or touch screen.

5.16.1 Configuring Connectivity Card

Pairing the LiNX system with a user's device

To pair the LiNX system with a user's device (PC, laptop or mobile device), open the connectivity settings menu.

1.



Fig. 5-35

Long press navigation button (A).

2.

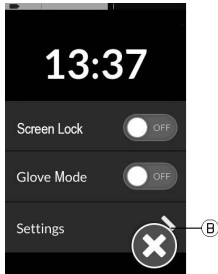

Fig. 5-36

Status display opens. Open Settings menu (B).

3.

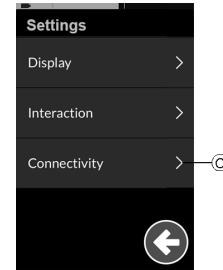

Fig. 5-37

Settings menu opens. Open Connectivity settings (C).

4.

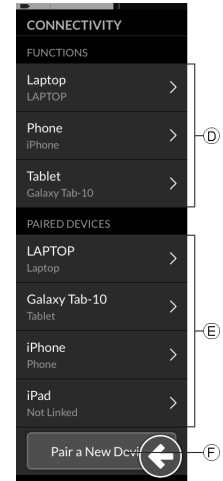

Fig. 5-38

Connectivity settings menu opens. This menu is split into two sections:

- ⓓ Functions
- ⓔ Paired devices

5. Tap on **Pair New Device** button ⓕ at bottom of menu.

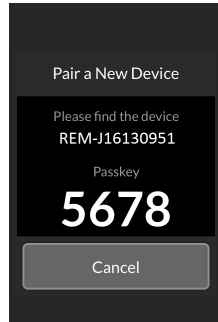

Fig. 5-39

Pairing passkey is displayed on touch screen with the name of LiNX device to pair with, in this example REM-J16130951.

Pairing mobile device with LiNX system

- ⓘ Perform this operation promptly to the Pairing process on your remote (see *Pairing the LiNX system with a user's device, page 62*). Otherwise, a timeout will occur.

See your mobile device's user manual for information about how to establish a Bluetooth connection with your remote.

Pairing PC or Laptop with LiNX system

- ⓘ Perform this operation promptly to the Pairing process on your remote (see *Pairing the LiNX system with a user's device, page 62*). Otherwise, a timeout will occur.

1. Open **Devices and Printers** dialog box on your Windows PC or laptop.
There are a number of ways to do this:

- Start → Devices and Printers,
- Start → Control Panel → Devices and Printers,
- Icon tray → click on Bluetooth Device icon

2.

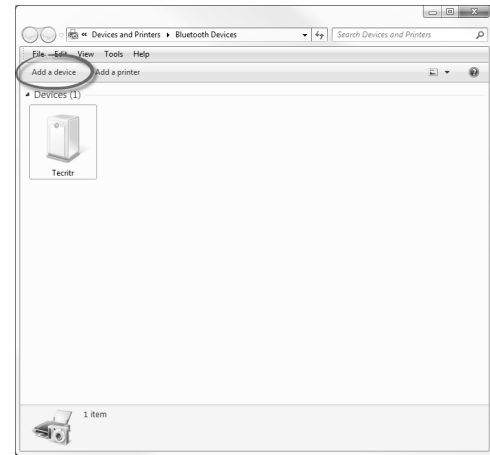

Fig. 5-40

From **Devices and Printers** dialog box, click on **Add a device** button.

3.



Fig. 5-41

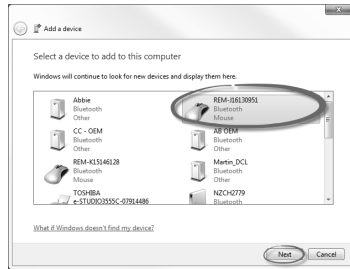

Fig. 5-42

All available devices are displayed. Locate LiNX device name that as displayed on the touch screen (REM-J16130951) and select it. Click on **Next** button.

4.

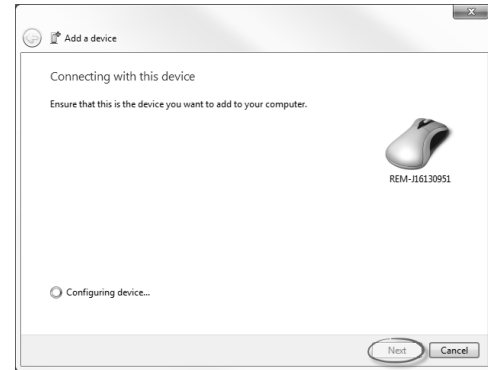

Fig. 5-43

Wait for device to connect. Click on **Next** as soon as device is connected.

5.

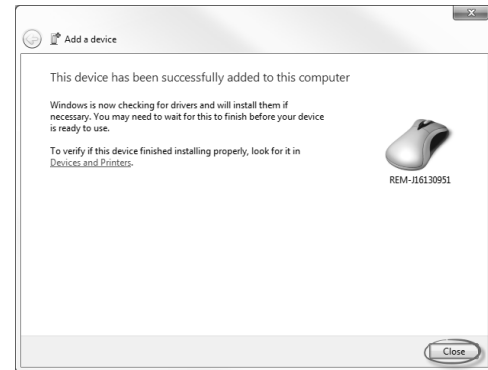

Fig. 5-44

Click on **Close** button to complete **Add a device** action.

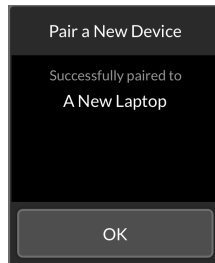

Fig. 5-45

If the device paired successfully, a confirmation screen is displayed on the remote module. Tap on the **OK** button to proceed.

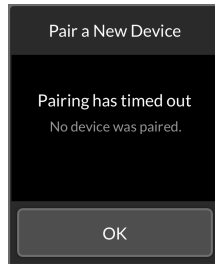

Fig. 5-46

If no device is paired within the set timeout period, a message is displayed “No device was paired”. Tap on **OK** button to proceed.



LiNX system permits up to ten devices to be paired at any time. If you have reached this limit and you need to add more devices, consider forgetting devices, that have already been paired, see *Operating the Mouse Mover*, page 74.

Linking connectivity card with user’s device

Connectivity cards must be linked to a paired device. To link a connectivity card to a device, open the connectivity settings menu.

1.

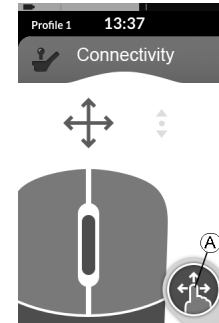

Fig. 5-47

Long press navigation button (A).

2.

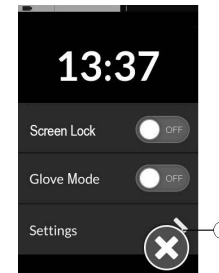

Fig. 5-48

Status display opens. Open Settings menu (B).

3.

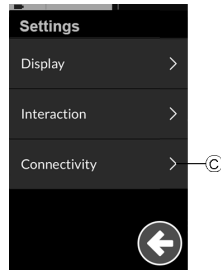

Fig. 5-49

Settings menu opens. Open Connectivity settings ③.

4.

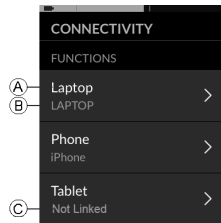

Fig. 5-50

The names of the connectivity cards are displayed in section **Functions**.

- ① Function name
- ② Linked device
- ③ No linked device

5. Tap on appropriate menu item to link connectivity card with a paired device.

6. If you use Mouse mover function card, cursor speed settings are displayed on top. Scroll down to section **Function Uses Device**.

7.



Fig. 5-51

Tap on **Not Linked** button ④.

1.

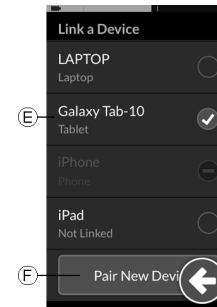



Select one of paired devices in list ⑤, or tap on **Pair New Device** button ⑥ to pair with new device. Currently active device is identified by a green hook behind the device name.

Connecting devices with LiNX system

To connect to a device, select the appropriate connectivity card from a profile. If the connectivity function has been paired to a device and the device has been linked to the function, then it attempts to connect to the device via Bluetooth.

The Bluetooth status indicator shows when the Bluetooth connection between the LiNX system and the user's device is:

-  disconnected,
-  connecting or
-  connected.

If the Bluetooth fails to connect, the status reverts to disconnected.

Removing paired devices

1.

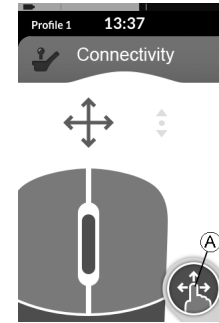

Fig. 5-52

Long press navigation button (A).

2.

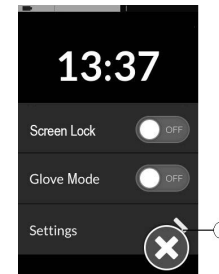

Fig. 5-53

Status display opens. Open Settings menu (B).

3.

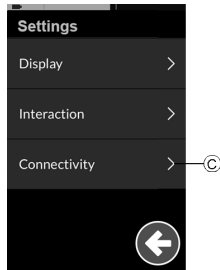

Fig. 5-54

Settings menu opens. Open Connectivity settings **C**.

4.

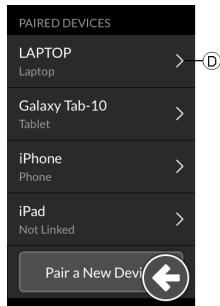

Fig. 5-55

Select paired device in section **Paired Devices**, e. g. Laptop **D**.

5.



Fig. 5-56

Check details on following screen and tap **Forget this Device** button.

6.

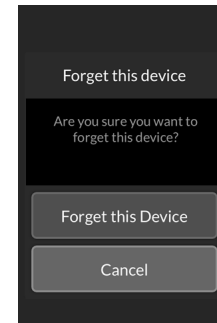

Fig. 5-57

Tap on **Forget this Device** button again or **Cancel** button, to cancel removing.

Selecting a connectivity card

For more information about selecting user function cards, see 5.2.2 *Using direct navigation, page 29* or 5.2.3 *Using indirect navigation, page 31*.

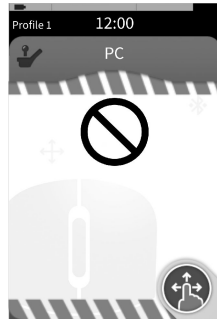

Fig. 5-58

If a connectivity card in the profile has not been configured fully or is subject to an error, it will be classed as inoperable, see image above.

There is a number of reasons why a connectivity card is inoperable. These are:

- the function's primary input is missing,
- there are hardware errors from the Bluetooth module,
- there is no device linked or
- Bluetooth has not been enabled.

For the latter two reasons, the card can be selected as these are rectified later.

5.16.2 Mouse Mover

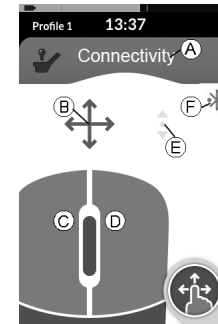



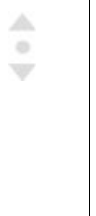



Fig. 5-59

- Ⓐ Connectivity card name
- Ⓑ Mouse move indicator
- Ⓒ Left mouse button
- Ⓓ Right mouse button
- Ⓔ Scroll indicator
- Ⓕ Bluetooth connection status

Connectivity card name		The name can be used to uniquely identify this card's purpose.
Mouse move indicator		The mouse move indicator changes from grey to blue when active. That is, when the user input is controlling the connected device's cursor.
Left and right mouse buttons		Tap on the touch screen's left and right mouse buttons to perform left and right mouse clicks.

Scroll indicator		The scroll indicator changes from grey to blue when active. That is, when the user input is controlling the connected device's scrolling.
Bluetooth status		The Bluetooth status indicator shows the status of the Bluetooth connection between the LiNX system and your device: <ul style="list-style-type: none"> • disconnected • connecting • connected

Setting up a Mouse Mover

The following set-up procedure assumes that connectivity cards are available and selectable in one or more profiles and that the connectivity cards provide mouse mover functions. It also assumes that the PC or laptop, to which the LiNX system will connect, has an active Bluetooth connection.

To use a mouse mover function:

1. the LiNX system needs to be paired (via Bluetooth) with a user's device, and
2. the connectivity card needs to be linked to the paired device.

The set-up procedure can be performed in any order, but involves the following:

- Selecting a connectivity card,
- pairing the LiNX system with a user's device
- linking the connectivity card with the user's device and
- configuring the mouse mover function (cursor speed).

Configuring the mouse mover function (cursor speed)

The cursor speed settings can be found in the connectivity function's menu.

1.

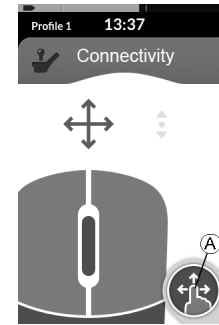

Fig. 5-60

Long press navigation button (A).

2.

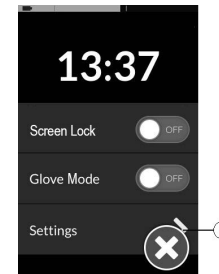

Fig. 5-61

Status display opens. Open Settings menu (B).

3.

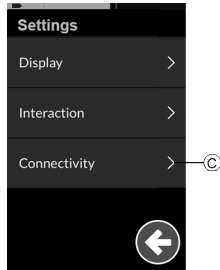

Fig. 5-62

Settings menu opens. Open Connectivity settings ③.

4.

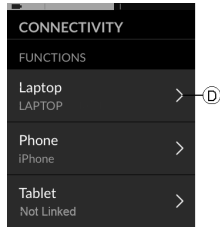

Fig. 5-63

Open connectivity function, e.g. ④, to configure cursor settings.

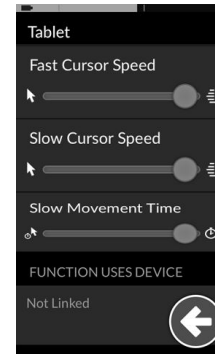

Fig. 5-64 Mouser mover — Cursor settings

For each mouse mover function the following cursor settings can be set:

- Fast Cursor Speed
- Slow Cursor Speed
- Slow Movement Time

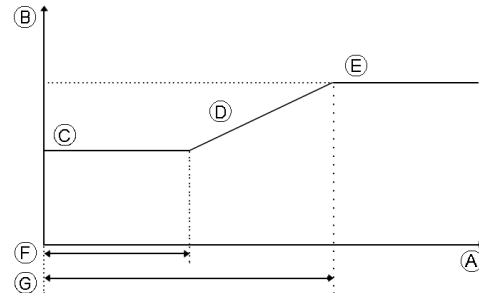

Fig. 5-65

- Ⓐ X-axis: time
- Ⓑ Y-axis: speed
- Ⓒ Slow Cursor Speed
- Ⓓ Ramp
- Ⓔ Fast Cursor Speed
- Ⓕ Slow Movement Time
- Ⓖ 2x Slow Movement Time

Slow Cursor Speed Ⓒ: Sets the speed at which the mouse cursor moves when initially deflected. It remains at this speed for the duration set by the Slow Movement Time Ⓕ. The Slow Cursor Speed is set so that you can move the mouse cursor slowly over small distances, which is useful for small adjustments, especially when moving between screen icons that are close together. Slow Cursor Speed should be set equal to or less than Fast Cursor Speed Ⓔ.

Fast Cursor Speed Ⓔ: Sets the speed at which the mouse cursor ramps Ⓓ up to after the Slow Movement Time Ⓕ has expired. During the Slow Movement Time however, the mouse cursor speed moves at the speed set by Slow Cursor Speed Ⓒ. The Fast Cursor Speed is set so that you can move the cursor quickly over large distances. Fast Cursor Speed should be set equal to or greater than Slow Cursor Speed.

Slow Movement Time Ⓕ: Sets the length of time for which the mouse moves at the Slow Cursor Speed Ⓒ before increasing to the Fast Cursor Speed Ⓔ. The ramp time, between end of Slow Cursor Speed and start of Fast Cursor Speed, is equal to the time set by this setting Ⓖ.

Operating the Mouse Mover

The following operation description assumes that a connectivity card with a mouse mover function has been set up as described in *Setting up a Mouse Mover, page 71*.

Moving the cursor

The cursor moves on the user's device in the direction that is mapped to the input. The speed of the cursor is slow initially, which is ideal for close or fine movements and then speeds up after a short period (defined by Slow Movement Time) to allow the cursor to move a greater distance in a shorter time frame. For more information about cursor settings, see *Setting up a Mouse Mover, page 71*.

Right or left click

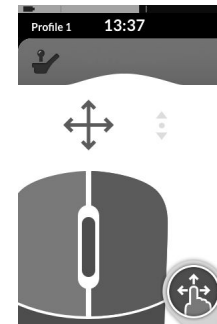

Fig. 5-66

To perform a right or left click, tap on the corresponding buttons on the touch screen. When a button is tapped, it changes color from grey to blue.

Scrolling

The scroll mode button is an external button, such as an egg switch or buddy button.

1. Press and hold scroll mode button.
2. Use assigned user input or programmed control inputs to perform up and down scroll actions.
3. To stop scrolling, release scroll mode button.

Disconnecting

To stop using the mouse mover function, select a different function card from a profile. When the connectivity card has been deselected, the Bluetooth connection disconnects.

5.16.3 Switch Control

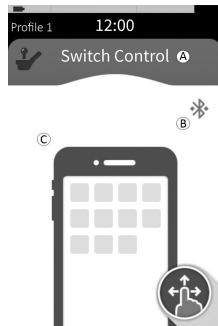

Fig. 5-67

- Ⓐ Connectivity card name
- Ⓑ Bluetooth connection status
- Ⓒ Switch control indication

Connectivity card name		The name can be used to uniquely identify this card's purpose.
Bluetooth status		The Bluetooth status indicator shows the status of the Bluetooth connection between the LiNX system and your device: <ul style="list-style-type: none"> • disconnected • connecting • connected
Switch control indication		The switch control indication varies depending on if your device is connected via Bluetooth and whether or not a switch control input is active: <ul style="list-style-type: none"> • disconnected • connected • active

Setting up switch control

The following set up procedure assumes that a switch control connectivity card is available and selectable in one or more profiles. It also assumes that the user's device (iOS or Android) to which the LiNX system connects to, has an active Bluetooth connection.

To use a switch control function:

1. the LiNX system needs to be paired (via Bluetooth) with a user's device, and
2. the switch control connectivity card needs to be linked to the paired device.

The set up process is performed in any order, but will involve the following:

- Selecting a switch control connectivity card,
- pairing the LiNX system with a user's device,
- linking the switch control connectivity card with the user's device, and
- configuring switch control.

Configuring switch control

Before you can use switch control, you need to identify the switches you will be using and assign an action to each switch. For example, if you want your mobile phone to return to Home screen when you tap on the remote's touch screen, you will need to identify the touch screen as a switch input, and then assign that switch's action to Home button.

Configuring Switch Control (Android)

Based on different Android version in the market, the description on your mobile device can differ. For more information look into your user manual or at **Android Accessibility Help** pages.

1.

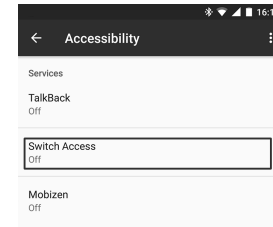

Fig. 5-68

Settings > Accessibility > Switch Access

Open the switch control menu on your mobile device.

2.

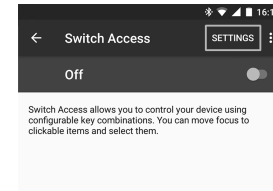

Fig. 5-69

Open **Settings** (Settings) menu.

3.

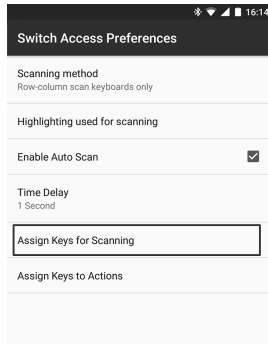

Fig. 5-70

Open **Assign Keys for Scanning** (Assign Keys for Scanning) menu or **Assign Keys to Actions** (Assign Keys to Actions) menu. Android placed functions in two different menus.

4.

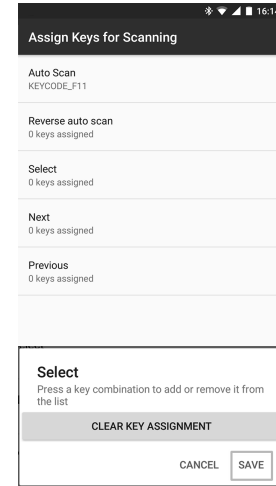

Fig. 5-71

Select the function you like to control from the list, such as **Select** (Select). You are prompted to activate your external switch.

5.



Fig. 5-72

Activate the external switch, for example tap on Touch screen or deflect joystick to the left.

6. Click on button **Save** (Save).

7. If required, repeat the steps to add more switches.

8.

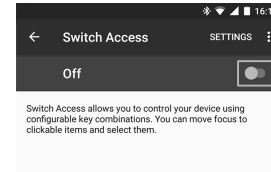

Fig. 5-73

Activate Switch Control.

9.

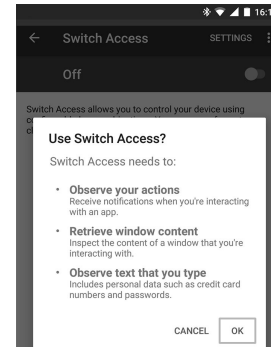

Fig. 5-74

Click button **OK** to activate Switch Control.

Configuring Switch Control (iOS)

1.

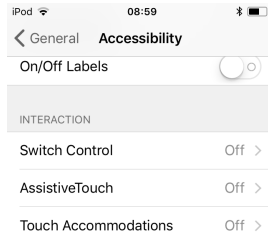

Fig. 5-75

Settings > General > Accessibility

Open the switch control menu on your mobile device.

2.



Fig. 5-76

Open **Switches** (Switches) menu.

3.

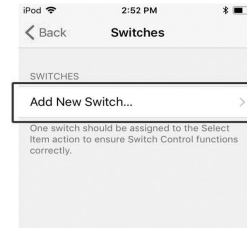

Fig. 5-77

Tap on menu entry **Add new Switch** (Add New Switch).

4.

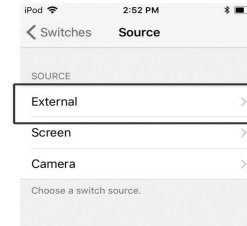

Fig. 5-78

Tap on button **External** (External). You are prompted to activate the external switch.

5.

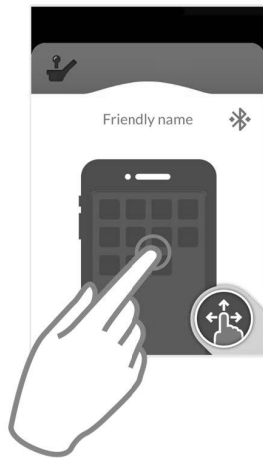

Fig. 5-79

Activate external switch, for example tap on Touch screen or deflect joystick to the left.

6.

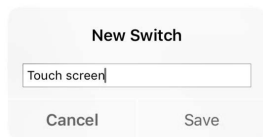

Fig. 5-80

Name external input with a unique name of your input, such as **Touch screen** or **Right**. After that, click on button **Save** (Save).

7.

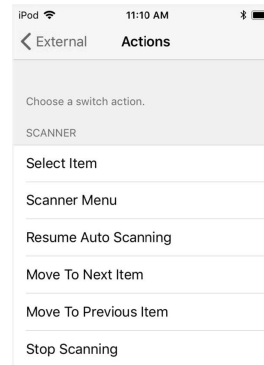

Fig. 5-81

Assign an action to switch. From the **Actions** (Actions) menu choose a switch action, such as **Select Item**.

8. If required, repeat the steps to add more switches.
- 9.

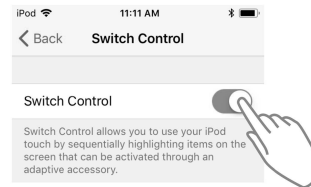

Fig. 5-82

Activate Switch Control.

Operating Switch Control

The following operation description assumes that a connectivity card with a switch control function has been set up as described in *Setting up switch control*, page 75.

Controlling Mobile Device

1. Press the preassigned switch on your remote. Your mobile device executes the deposited action.

Disconnecting

To stop using switch control function, select a different function card from a profile. When the switch control connectivity card has been deselected, the Bluetooth connection disconnects.

5.17 Using secondary inputs



CAUTION!

Risk of injury

If an external input is used, unrequested functions or speed settings can lead to unexpected operations.

- To avoid unexpected operations, check which function is operated and what the function's speed is set to.

If you are unable to use a standard joystick, you can control the system via an external input. All following inputs are able to control the driving function. With some of the following inputs you are also able to switch the function cards to control seating or light functions, if available.

In case of a proportional joystick or the Sip and Puff Head Array, the wheelchair can be driven forward, reverse, right or left by a four-quadrant (4Q) operation without additional switches. This is different to an operation based on three quadrants (3Q), such as a Head Array or a Four Switch Proximity Array. There you have the possibility to move

forward, right or left with the aid of proximity sensors. In order to allow the wheelchair to be driven in reverse or changing function cards, an additional switch or sensor is required.

The Head Array and the Four Switch Proximity Array are provided with an Atom Box, so your provider can fit the arrays to your individual needs by using the dip switches.

Default dip switch setup:

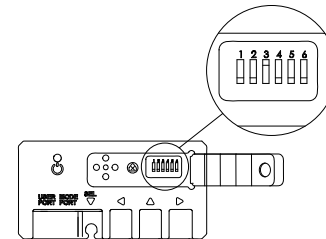

Fig. 5-83

- 1 Reset/Reverse switch turned off.
- 2 Not used at the moment.
- 3 Turned on, to power up with wheelchair.
- 4 Not used at the moment.
- 5 Not used at the moment.
- 6 Audible input indicator turned off.



All components mentioned below describe the usage of the default set-up. For individual set-up, contact your provider.

5.17.1 Using Manual Swing-Away Chin Control



WARNING!

Risk of Injury or Death

Small parts can lead to choking hazard that may result in injury or death.

- Do not remove any small parts.
- Closely supervise children, pets or people with physical/mental disabilities.



CAUTION!

Risk of Injury and Damage

Remaining burrs and missing end caps after modifications on rods, such as shortened rod, can lead to injury or damage.

- Deburr cut after cutting excessive length.
- Re-install end cap after deburring.
- Check end cap for tight fitting.



CAUTION!

Risk of Injury or Damage

Clothes or personal accessories can restrict or prohibit correct function of Chin Control.

- Check correct wiring of cables before first use.
- Ensure that no clothes or accessories are in range of use at any time.



Risk of Damage

Additional items not belonging to Chin Control can damage it.

- Do not hang items, such as clothes or accessories, on any parts of Chin Control.

Driving

This proportional joystick needs less force to be deflected than a standard joystick.

1.

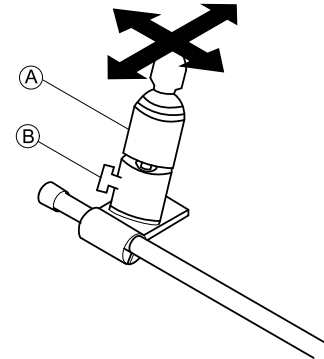

Fig. 5-84

Deflect joystick (A) from neutral position in desired direction.

For more information about driving, see *5.5 Proportional driving mode, page 39*.



You can use wing bolt (B) to adjust the joystick to your needs.

Changing function cards

By default an egg switch, used for function or profile changes, is mounted to the headrest.



For difference between function card and profile, see *3.2.3 User Function Card Overview, page 11*.

1. Short press egg switch to change function card.
2. Long press egg switch to change profile.

For operating the powered seating functions, see 5.15.1 *Through Seating Cards*, page 54.

Moving controls inwards / outwards

- 1.

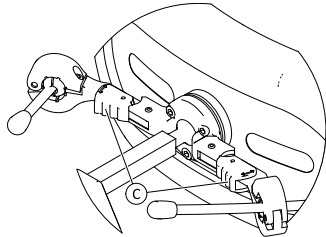

Fig. 5-85

Press locking device © (behind headrest) and swivel joystick or egg switch inwards or outwards until it clicks in place.

5.17.2 Using Powered Swing-Away Chin Control



WARNING!

Risk of Injury or Death

Small parts can lead to choking hazard that may result in injury or death.

- Do not remove any small parts.
- Closely supervise children, pets or people with physical/mental disabilities.



CAUTION!

Risk of Injury and Damage

Remaining burrs and missing end caps after modifications on rods, such as shortened rod, can lead to injury or damage.

- Deburr cut after cutting excessive length.
- Re-install end cap after deburring.
- Check end cap for tight fitting.



CAUTION!

Risk of Injury or Damage

Clothes or personal accessories can restrict or prohibit correct function of Chin Control.

- Check correct wiring of cables before first use.
- Ensure that no clothes or accessories are in range of use at any time.



Risk of Damage

Additional items not belonging to Chin Control can damage it.

- Do not hang items, such as clothes or accessories, on any parts of Chin Control.

Driving

This proportional joystick needs less force to be deflected than a standard joystick.

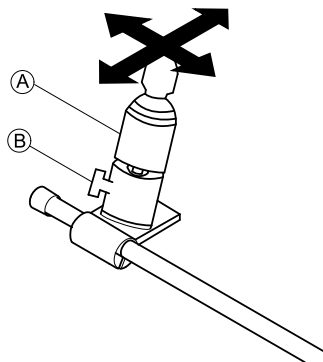

Fig. 5-86

1. Deflect joystick (A) from neutral position in desired direction.

For more information about driving, see 5.5 *Proportional driving mode*, page 39.

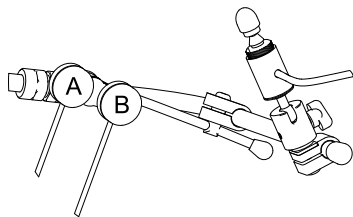

Fig. 5-87

Changing Function Cards

By default a black Piko button (B) is mounted to Chin beam.



For difference between function card and profile, see 3.2.3 *User Function Card Overview*, page 11.

1. Short press black button to change function card.
2. Long press black button to change profile.

For operating the powered seating functions, see 5.15.1 *Through Seating Cards*, page 54.

Switching Mobility Device off/on

By default a red Piko button (A) is mounted to Chin beam.

1. Press red button to turn mobility device off/on.

Moving Chin Control Inwards and Outwards Electrically

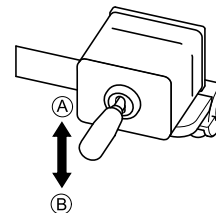

Fig. 5-88

The linkage joystick controls the movement of the Chin Control.

See table for possible movements:

Joystick position	Movement
up (A)	Chin Control moves upwards and outwards
down (B)	Chin Control moves downwards and inwards

1. Move linkage joystick in desired direction until Chin Control is in desired position.

5.17.3 Using the Compact Single Switch Joystick

Driving

1.

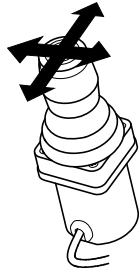

Deflect joystick from neutral position in desired direction.

For more information about driving, refer to *5.5 Proportional driving mode, page 39*.

Changing function cards



For difference between function card and profile, refer to chapter *3.2.3 User Function Card Overview, page 11*.

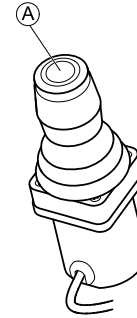

1. Short press joystick button **A** to change function card.
2. Long press joystick button **A** to change profile.

For operating the powered seating functions, refer to *5.15.1 Through Seating Cards, page 54*.

5.17.4 Using Micro Extremity Control Joystick



WARNING!

Risk of Injury or Death

Loose small parts can lead to choking hazard that may result in injury or death.

- Do not remove any small parts except to replace the joystick knob.
- Do not leave removed joystick knob unattended.
- Closely supervise children, pets or people with physical/mental disabilities.

This proportional joystick needs only little force to be deflected.

Driving

1.



Fig. 5-89

Deflect joystick from neutral position to drive in desired direction.

For more information about driving, refer to *5.5 Proportional driving mode, page 39*.

Changing Function Cards



For difference between function card and profile, refer to chapter *3.2.3 User Function Card Overview, page 11*.

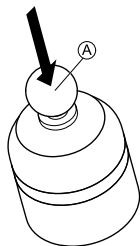

1. Short press joystick Ⓐ to change function card.
2. Long press joystick Ⓐ to change profile.

For operating the powered seating functions, refer to *5.15.1 Through Seating Cards, page 54*.

5.17.5 Using Pediatric Compact Joystick



WARNING!

Risk of Injury or Death

Loose small parts can lead to choking hazard that may result in injury or death.

- Do not remove any small parts except to replace the joystick knob.
- Do not leave removed joystick knob unattended.
- Closely supervise children, pets or people with physical/mental disabilities.

Driving

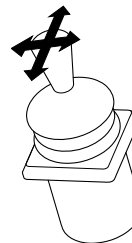



Fig. 5-90

1. Deflect joystick from neutral position to drive in desired direction.

For more information about driving, refer to *5.5 Proportional driving mode, page 39*.

Changing Function Cards

Refer to *5.2 Navigating through user function cards, page 28* for more information about changing the function cards.

 For difference between function card and profile, refer to chapter *3.2.3 User Function Card Overview, page 11*.

For operating the powered seating functions, refer to *5.15.1 Through Seating Cards, page 54*.

5.17.6 Using the Sip-N-Puff



CAUTION!

Risk of Injury or Damage

Improper mounting or maintenance of the Sip-N-Puff control including the mouthpiece and breath tube may cause injury or damage. Water inside the Sip-N-Puff interface module may cause damage to the unit. Excessive saliva residue in the mouthpiece can reduce performance. Blockages, a clogged saliva trap or air leaks in the system may cause Sip-N-Puff not to function properly.

- Ensure moving parts of the wheelchair, including the operation of powered seating, DO NOT pinch or damage the Sip-N-Puff tubing.
- Saliva trap MUST be installed to reduce risk of water or saliva entering the Sip-N-Puff interface module.
- Flush the mouthpiece and the breath tube at least twice a week with warm running water. Disinfect with oral rinse after cleaning.
- The mouthpiece MUST be completely dry before installation.
- If Sip-N-Puff does not function properly, inspect system for blockages, clogged saliva trap or air leaks. As necessary, replace mouthpiece, breath tube and saliva trap.



For further maintenance and cleaning instructions, see *6 Maintenance, page 101*



Sip and Puff is not the most manoeuvrable or intuitive control method and therefore requires a considerable amount of training. In the early tuning stages, this is best done outdoors in an unrestricted but safe area. Also the presence of an attendant is recommended.

Driving

The drive function cards for the Sip-N-Puff are pre-set in latched driving mode. For more information, see *5.6 Latched driving mode, page 41*.

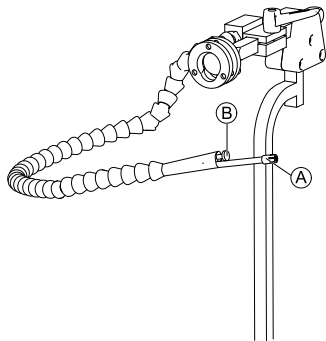

Fig. 5-91

1. Puff hard into mouthpiece **A** to drive forwards.
2. Sip hard at mouthpiece to drive in reverse.
3. When in latched driving mode, puff soft into mouthpiece to veer to the right.
4. When in latched driving mode, sip soft at mouthpiece to veer to the left.



For more information about the calibration of hard and soft demands, see the service manual of the LiNX system.

Stopping

A lipswitch **B** is mounted to the mouthpiece. This switch can be used as an external stop switch, when in latched driving mode. While you are in latched driving, you do not need to give a drive demand all the time, but the mouthpiece must stay inside your mouth. As soon as the lipswitch is pressed while driving, the wheelchair stops.

Changing Function Cards

The lipswitch can also be used as a mode function switch.



For difference between function card and profile, see *3.2.3 User Function Card Overview, page 11*.

1. Stop wheelchair.
2. Short press lipswitch to change function card.
3. Long press lipswitch to change profile.

5.17.7 Using the Sip-N-Puff Head Array



WARNING!

Risk of serious injury

Proximity sensors are sensitive to water. If enough water is present close to sensors, they may be activated and mobility device may start moving unintentionally.

- Do not operate Head Array with wet hair.
- Do not operate Head Array in wet weather.
- Do not operate Head Array in any circumstances where water may come close to sensors.



WARNING!

Risk of serious injury

Sensor pads are made of water resistant vinyl to get water quickly run off the pads before activating sensors.

If sensor pads are damaged, water may get in and mobility device may start driving unintentionally. If sensor pads are covered by water absorbing material, mobility device may start driving unintentionally.

- Do not operate Head Array if sensor pads are damaged. Change sensor pads immediately.
- Do not cover sensor pads with any material.



CAUTION!

Risk of Injury or Damage

Improper mounting or maintenance of the Sip-N-Puff control including the mouthpiece and breath tube may cause injury or damage. Water inside the Sip-N-Puff interface module may cause damage to the unit.

Excessive saliva residue in the mouthpiece can reduce performance.

Blockages, a clogged saliva trap or air leaks in the system may cause Sip-N-Puff not to function properly.

- Ensure moving parts of the wheelchair, including the operation of powered seating, DO NOT pinch or damage the Sip-N-Puff tubing.
- Saliva trap **MUST** be installed to reduce risk of water or saliva entering the Sip-N-Puff interface module.
- Flush the mouthpiece and the breath tube at least twice a week with warm running water. Disinfect with oral rinse after cleaning.
- The mouthpiece **MUST** be completely dry before installation.
- If Sip-N-Puff does not function properly, inspect system for blockages, clogged saliva trap or air leaks. As necessary, replace mouthpiece, breath tube and saliva trap.



For further maintenance and cleaning instructions, see *6 Maintenance, page 101*



Sip and Puff is not the most manoeuvrable or intuitive control method and therefore requires a considerable amount of training. In the early tuning stages, this is best done outdoors in an unrestricted but safe area. Also the presence of an attendant is recommended.

Inside the Head Array pads, there are proximity sensors, that allow you to steer the wheelchair in the desired direction with the movement of your head. This means that the head does not need to touch the pads or press a switch to activate driving. If the head comes within 6 mm of a sensor, the sensor is activated and the wheelchair starts driving.

By default, the Head Array powers up as soon as the wheelchair is powered up and powers down as soon as the wheelchair is powered down.



Be aware, that when powering up automatically with the wheelchair, your head has to be more than 6 mm away from the proximity sensors, otherwise a drive OON warning is displayed and prevents the wheelchair from driving. For more information about OON, see 7.2 OON (“Out Of Neutral”), page 105

Driving

This component combines simple sip and puff controls with head movements. Right and left turns are controlled by sensors located in the pads of the Head Array.

The drive function cards for the Sip-N-Puff Head Array are pre-set in latched driving mode. For more information, see 5.6 Latched driving mode, page 41.

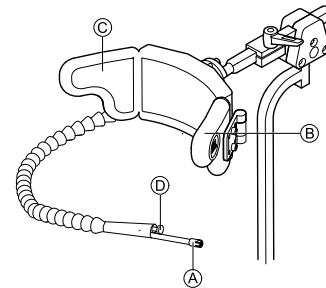

1. Puff into mouthpiece (A) to drive forwards.
2. Sip at mouthpiece (A) to drive in reverse.
3. When in latched driving mode, activate left pad (B) to veer to the left.
4. When in latched driving mode, activate right pad (C) to veer to the right.



To revolve, you only need to activate left or right pad.

Stopping

A lipswitch (D) is mounted to the mouthpiece. This switch can be used as an external stop switch, when in latched driving mode. While you are in latched driving, you do not need to give a drive demand all the time, but the mouthpiece must stay inside your mouth. As soon as the lipswitch is pressed while driving, the wheelchair stops.

Changing Function Cards

The lipswitch can also be used as a mode function switch.



For difference between function card and profile, see 3.2.3 User Function Card Overview, page 11.

1. Stop wheelchair.
2. Short press lipswitch to change function card.
3. Long press lipswitch to change profile.



Fig. 5-92

Seating functions can only be operated with the right or left pad of the head array.

5.17.8 Using the Head Array



WARNING!

Risk of serious injury

Proximity sensors are sensitive to water. If enough water is present close to sensors, they may be activated and mobility device may start moving unintentionally.

- Do not operate Head Array with wet hair.
- Do not operate Head Array in wet weather.
- Do not operate Head Array in any circumstances where water may come close to sensors.



WARNING!

Risk of serious injury

Sensor pads are made of water resistant vinyl to get water quickly run off the pads before activating sensors.

If sensor pads are damaged, water may get in and mobility device may start driving unintentionally. If sensor pads are covered by water absorbing material, mobility device may start driving unintentionally.

- Do not operate Head Array if sensor pads are damaged. Change sensor pads immediately.
- Do not cover sensor pads with any material.

The Head Array is a three-quadrant operation. Inside the Head Array pads, there are proximity sensors, that allow you to steer the wheelchair in the desired direction with the movement of your head. This means that the head does not need to touch the pads or press a switch to activate driving. If the head comes within 6 mm of a sensor, the sensor is activated and the wheelchair starts driving.

By default, the Head Array powers up as soon as the wheelchair is powered up and powers down as soon as the wheelchair is powered down.



Be aware, that when powering up automatically with the wheelchair, your head has to be more than 6 mm away from the proximity sensors, otherwise a drive OON warning is displayed and prevents the wheelchair from driving. For more information about OON, refer to 7.2 OON (“Out Of Neutral”), page 105

Driving

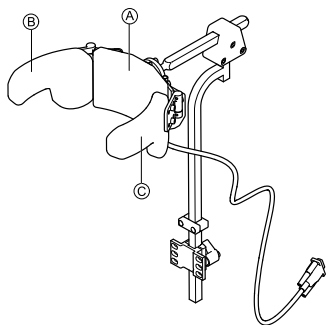

1. Activate forward drive function card.
Activate center pad **A** to drive forwards.
2. Change to reverse drive function card.
Activate center pad **A** to drive in reverse.
3. Change back to forward drive function card.
Activate center pad **A** and right pad **B** at the same time to veer to the right.
4. Activate center pad **A** and left pad **C** at the same time to veer to the left.

Indicators for forward and reverse are shown in the display.

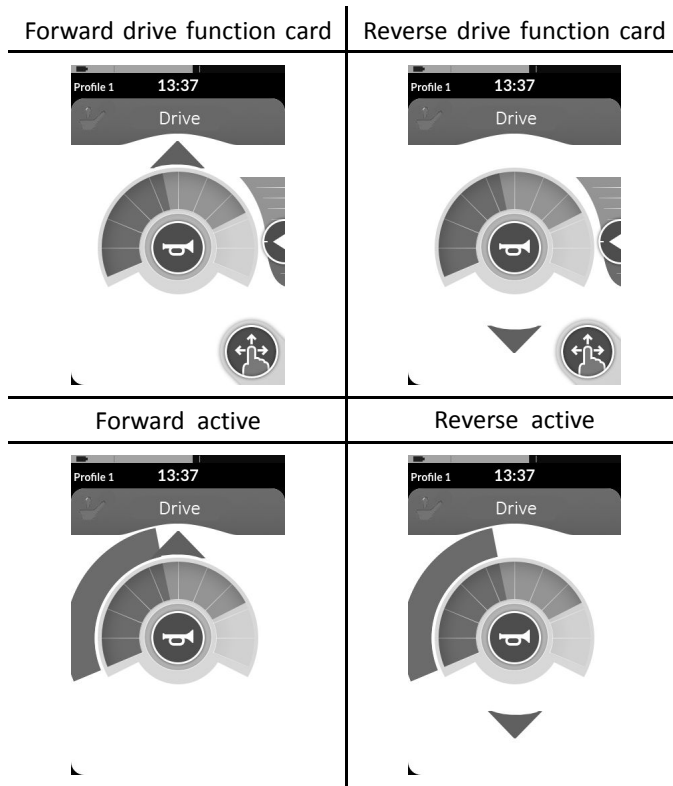

To revolve, you only need to activate left or right pad.

Changing function cards

 For difference between function card and profile, refer to *3.2.3 User Function Card Overview, page 11*.

1. Short press mode switch to change function card.
2. Long press mode switch to change profile.



Seating functions can only be operated with the right or left pad of the head array.

5.17.9 Using the Four Switch Proximity Array



WARNING!

Risk of serious injury

Proximity sensors are sensitive to water. If enough water is present close to sensors, they may be activated and mobility device may start moving unintentionally.

- Do not operate Four Switch Proximity Array in wet weather.
- Do not operate Four Switch Proximity Array in any circumstances where water may come close to sensors.

The Four Switch Proximity Array is a three-quadrant operation. The Four Switch Proximity Array offers four proximity sensors that allow to operate a mobility device or change the function cards. The sensors are activated, as soon as an input comes within 6 mm of the sensors.

By default, the sensors power up as soon as the wheelchair is powered up and power down as soon as the wheelchair is powered down.



Be aware, that when powering up automatically with the wheelchair, you must not cover the proximity sensors, otherwise a drive OON warning is displayed and prevents the wheelchair from driving. For more information about OON, refer to *7.2 OON (“Out Of Neutral”)*, page 105



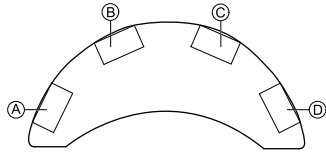

The picture below shows a configuration example in combination with an Eclipse Tray. For individual adjustment, contact your provider.

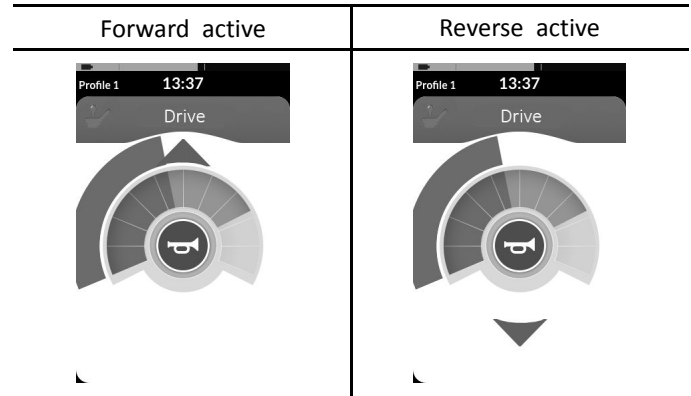
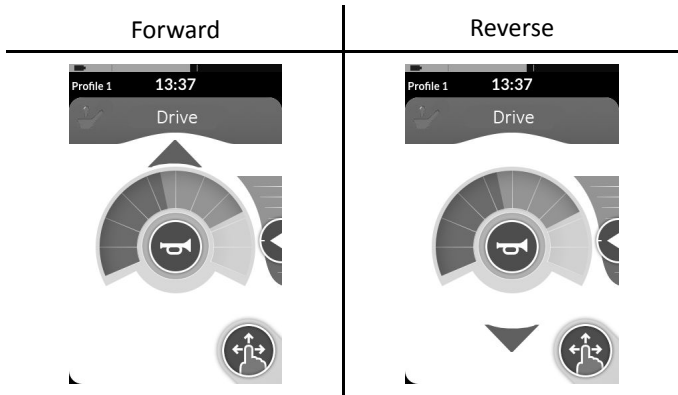

1. Cover sensor **B** to drive forwards.
2. To drive in reverse, cover sensor **D** to change direction. Cover sensor **B** to drive in reverse.
3. Cover sensors **A** and **B** to veer to the left.
4. Cover sensors **C** and **B** to veer to the right.
5. Cover sensor **D** to change function card.

Indicators for forward and reverse are shown in the display.



 To revolve, you only need to cover sensors **A** or **C**.

5.17.10 Using the Remote Stop Switch

The Remote Stop Switch allows a wheelchair to be stopped within a range of approximately six meters (20 feet).

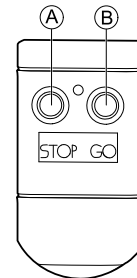

1. Press the STOP button **A** to stop wheelchair.
2. Press GO button **B** to allow wheelchair to move again.



In case you lose the remote and the wheelchair cannot be operated, disconnect the jack plug of the Remote Stop Switch box from the power module.

5.17.11 Using the Wireless Mouse Emulator

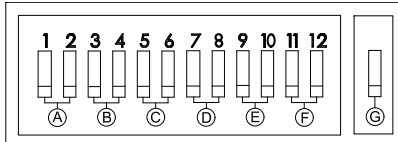

1. Turn on the Bluetooth on your proton box by pressing an external switch until you hear a long beep.
2. Connect the Wireless Mouse Emulator via the USB port with your computer.
3. Mouse emulator and Head Array connect automatically.
4. Default set up is:
 - Back pad: Mouse moves up and down
 - Right pad: Mouse moves left and right
 - Left pad: select

Mouse movement and behaviour can be changed via the switches at the back of the Wireless Mouse Emulator.

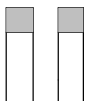
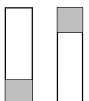
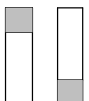
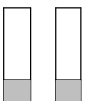
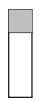

A	Dip switch 1 & 2: Initial mouse movement			
slow	medium slow	medium fast	fast	

B	Dip switch 3 & 4: Maximum cursor or mouse speed			
disabled	2x base	4x base	8x base	
C	Dip switch 5 & 6: Cursor delay			
disabled	1.0 sec	2.0 sec	4.0 sec	
D	Dip switch 7 & 8: Switch delay			
disabled	0.5 sec	1.0 sec	2.0 sec	
E	Dip switch 9 & 10: Latch delay			
disabled	1.0 sec	2.0 sec	4.0 sec	

F	Dip switch 11 & 12: Cursor movement options			
				
	3 switch	4 switch	4 switch	5 switch
G				
	OFF	ON		

A	This is a slower speed initially for precise targeting. It is set and used in conjunction with Cursor Delay to give the user the ability to move the mouse slowly at first and then speed up after a set amount of time to move across the screen efficiently.
B	This setting controls the maximum speed of the cursor and is the speed that the mouse will obtain after the initial speed. Note: The base speed is set in the control panel of the computer's mouse settings.
C	This is the initial amount of time the switch must be pressed and held before the mouse speeds up. This setting is used in conjunction with Initial Mouse Movement and Maximum Cursor settings.
D	This setting controls the amount of time the directional switches must be activated before the cursor will move. This is to allow for inadvertent switch closures. Note: This applies to directional switches only.

E	This setting controls the amount of time the Left and Right Click switch must be held before it will latch. Once the latch is no longer required, press the Right Click or Left Click switch for the same length of time to deactivate the latch.
F	Switch 11 and 12 should be in the DOWN position when using with the Head Array for 3 switch mouse emulation.
G	OFF: Original mouse speed, better for PC. ON: Increases mouse speed by 1/3, better for MAC.

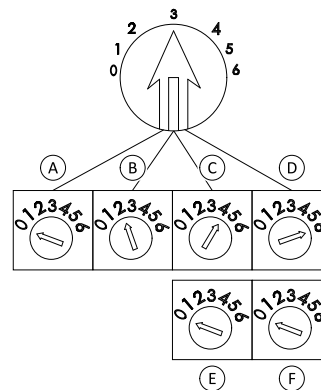



Fig. 5-93

Numbers 0 to 6 describe the action the mouse should perform. Letters A to F describe the direction of the input, which leads to the mouse action.

Number	Mouse action
0	No change
1	Down
2	Left
3	Right
4	Up
5	Right click
6	Left click

The following adjustments are examples only and can be adjusted to your needs by your provider.

	Input direction	Mouse action
Ⓐ	Reverse	No change
Ⓑ	Left	Left and right mouse direction
Ⓒ	Right	Up and down mouse direction
Ⓓ	Forward	Left click
Ⓔ	Left click	No change
Ⓕ	Right click	No change

 Input direction/Mouse action (0–6) cannot be duplicated in any two switches, except for zero.

5.18 Disabling Bluetooth

The embedded Bluetooth functionality can be disabled when powering up the system.

1. Press and hold the ON/OFF button for more than three seconds.



The disabled Bluetooth functionality is indicated by an icon in the status bar and the status LED inside the ON/OFF button pulsing for a duration of six seconds.

Bluetooth functionality resumes the next time the system is powered up again.

5.19 Charging the Batteries



WARNING!

Risk of Injury, Damage or Death

Improper routing of charger cord(s) may cause tripping, entanglement or strangulation hazard that may result in injury, damage or death.

- Ensure all charger cord(s) are routed and secured properly.
- Close supervision and attention is needed when charging the wheelchair near children, pets or people with physical/mental disabilities.



Please cycle the power prior to charging if wheelchair has not been used within 24 hours. This will ensure the enhanced battery gauge registers the charge to give an accurate reading during use of wheelchair.

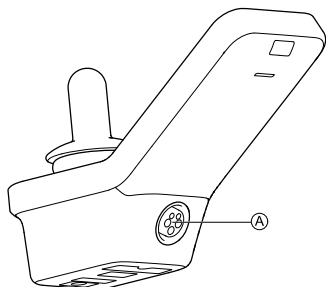

Fig. 5-94

1. Plug battery charger into remote's charger socket (A).

If remote is powered up, battery gauge indicates that system is connected to charger by displaying a charge sequence and then displaying the approximate battery charge state at the end of charge sequence.

	<p>Battery bar displays red when charge is < 20 %</p>
	<p>Battery bar displays orange when charge is between 20 % and 60 %</p>
	<p>Battery bar displays green when charge is between 60 % and 100 %</p>

Battery synchronisation

- i** **NEW Batteries Only**—The wheelchair power must be on during charging to ensure that accurate battery charge levels display on the remote. New batteries must be charged fully. The Battery synchronization Procedure **MUST** be performed within 24 hours of powering on the wheelchair. The Battery synchronization procedure can be found in the LiNX service manual and must be performed by a provider or qualified technician.

5.19.1 Battery alarms

Three battery alarms are shown on the right-hand side of the status bar:

Profile 12:00  Over voltage

This is displayed if the batteries are overcharged.
Disconnect the battery charger immediately.

Profile 12:00  Low voltage

This is displayed if the batteries are empty. Power down the wheelchair and charge the batteries immediately.

Profile 12:00  Deep discharge

This is displayed if the battery voltage falls below the voltage set by Cut Off Voltage. This indicates that the battery is empty and battery damage occurs if the battery is discharged any further. The horn also sounds once every ten seconds for the duration of active deep discharge status. Power down the wheelchair and charge the batteries immediately.

5.20 Using the USB charger



CAUTION! Risk of injury

If you use mobile phone while operating mobility device, accidents could lead to injury or property damage.

- Only use mobile phone in conjunction with hands-free equipment to operate mobility device while driving.



Risk of property damage

Handle USB charger with care, otherwise damage could occur.

- Always keep the USB charger dry. If USB charger gets wet, let USB charger dry before use.
- Do not use or store USB charger in dusty or dirty areas.
- Do not insert sharp objects into the USB ports.

With the USB charger you can charge the battery of your mobile phone or a compatible device when you do not have access to a regular power source. Both USB ports can be used at the same time and each USB port has a charging current up to 1 A.

1.

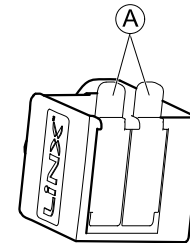

Open bung .

2. Connect device with USB port.



Replace bung when USB ports are not in use.



The usage of the USB charger influences the drive range of the mobility device. For more information about the drive range, refer to chapter Technical Data in the user manual of your mobility device.

6 Maintenance

6.1 Replacing Mouthpiece



Risk of Damage to Input Module

Improper mounting of mouthpiece may cause damage to input module by water or saliva.
 – Mouthpiece **MUST** be completely dry before installation.

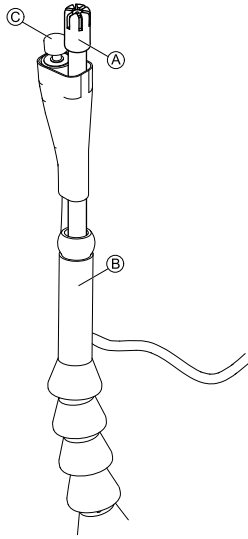

Fig. 6-1

1. Remove mouthpiece (A) from gooseneck (B). Make sure to leave lipswitch (C) in shrink sleeving which keeps together lipswitch and mouthpiece.
2. Insert new mouthpiece.

6.2 Replacing Saliva Trap



Risk of Damage to Input Module

If saliva trap is inserted wrong way round, input module can get damaged by water or saliva.
 – Make sure to insert saliva trap in correct orientation.
 – Saliva trap **MUST** be installed to reduce risk of water or saliva entering input module.

- 1.

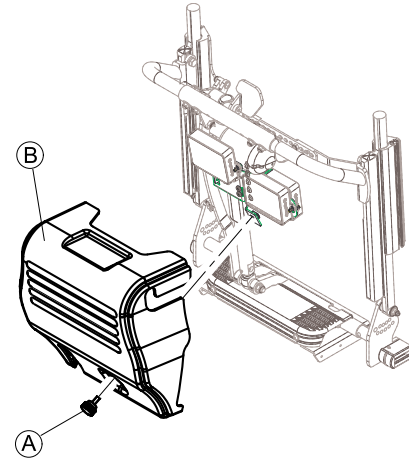

Fig. 6-2

Remove screw/hand screw (A) and backrest shroud (B).

2.

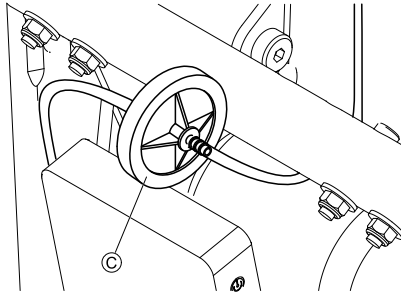

Fig. 6-3

Remove saliva trap (C) from tube.

3. Insert new saliva trap with *INLET* imprinting facing towards input module.

6.3 Cleaning Sip-N-Puff



Risk of Damage to Input Module

Improper mounting or maintenance of Sip-N-Puff control may cause damage to input module by water or saliva.

- Mouthpiece and breath tube **MUST** be completely dry before installation.

Cleaning at least twice a week is recommended.

1.

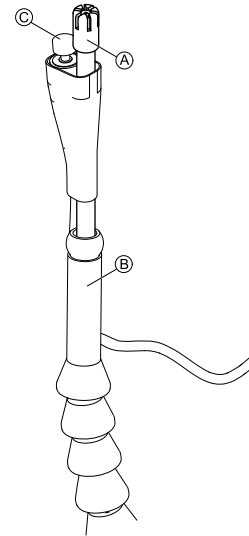

Fig. 6-4

Remove mouthpiece (A) and lipswitch (C) from gooseneck (B).

2. Remove breath tube from saliva trap. See *6.2 Replacing Saliva Trap, page 101*
3. Position catch can beneath breath tube to collect water and rinse.
4. Flush mouthpiece and breath tube with warm running water.
5. Rinse with oral rinse to disinfect.
6. Let dry completely before installation.
7. Install mouthpiece, lipswitch and breath tube.

7 Troubleshooting

7.1 Fault diagnosis

If the electronic system shows a fault, use the following fault-finding guide to locate the fault.

-  Ensure that the drive electronics system is powered up before starting any diagnosis.

If the status display is OFF:

- Check whether the drive electronics system is powered up.
- Check whether all cables are correctly connected.
- Ensure that the batteries are not discharged.

If a fault number is displayed in the status display:

- Proceed to the next section.

7.1.1 Fault Codes and Diagnosis Codes









If there is a fault with the system when it is powered up, a fault icon  is displayed in the status bar. The number inside the triangle indicates the type of fault.



Corresponding to that, the status LED inside the ON/OFF button flashes red. The number of flashes is identical to the one in the status bar.

The table below describes the fault indication and a few possible actions that can be taken to rectify the problem. The actions listed are not in any particular order and are suggestions only. The intention is that one of the suggestions may help you clear the problem. If in doubt, contact your provider.

Fault icon	Fault description	Possible action
	Remote fault	<ul style="list-style-type: none"> • Check cables and connectors. • Contact your provider.
	Network or configuration fault	<ul style="list-style-type: none"> • Check cables and connectors. • Recharge the batteries. • Check charger. • Contact your provider.
	Motor 1 ¹ fault	<ul style="list-style-type: none"> • Check cables and connectors. • Contact your provider.
	Motor 2 ¹ fault	<ul style="list-style-type: none"> • Check cables and connectors. • Contact your provider.
	Left magnetic brake fault	<ul style="list-style-type: none"> • Check cables and connectors. • Check left magnetic brake is engaged. • Refer to the chapter “Pushing the mobility device in freewheel mode” in the user manual of your wheelchair. • Contact your provider.

Fault icon	Fault description	Possible action
	Right magnetic brake fault	<ul style="list-style-type: none"> • Check cables and connectors. • Check right magnetic brake is engaged. • Refer to the chapter “Pushing the mobility device in freewheel mode” in the user manual of your wheelchair. • Contact your provider.
	Module fault (other than remote module)	<ul style="list-style-type: none"> • Check cables and connectors. • Check modules. • Recharge batteries. • If the chair was stalled, reverse away or remove obstacle. • Contact your provider.

1 Configuration of the motors depending on the wheelchair model

7.2 OON (“Out Of Neutral”)

OON (“Out Of Neutral”) is a safety feature that prevents accidental driving or seating movements, when:

- the system is powering up,
- after a function change or
- when the system comes out of an inhibit or drive lock-out.

Drive OON warning

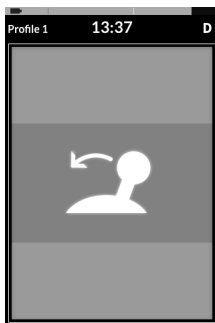

The joystick must be in the center position:

- when a system is powering up,
- on a function change or
- when transitioning from a drive lock-out or inhibit state.

Otherwise a drive OON warning is displayed. During a drive OON warning, the OON overlay is displayed and the wheelchair does not drive. If the joystick is returned to the center position, the warning clears and the wheelchair drives normally.

Seating OON warning



When a system is powering up or after a function change, no direct access switches can be active, otherwise a seating OON warning is displayed.

During a seating OON warning, the OON overlay is displayed and the seating motions do not operate. If the switches are deactivated, the warning clears and the seating motions operate normally.

8 Technical Data

8.1 Technical specifications

Mechanical specifications

Permissible operating, storage and humidity conditions	
Temperature range for operation according to ISO 7176-9:	<ul style="list-style-type: none"> -25° ... +50 °C
Recommended storage temperature:	<ul style="list-style-type: none"> 15 °C
Temperature range for storage according to ISO 7176-9:	<ul style="list-style-type: none"> -40° ... +65 °C
Operation humidity range according to ISO 7176-9:	<ul style="list-style-type: none"> 0 ... 90 %RH
Degree of protection:	IPX4 ¹

1 IPX4 classification means that the electrical system is protected against spray water.

Operating forces	
Joystick	<ul style="list-style-type: none"> 1.9 N
Power button	<ul style="list-style-type: none"> 2.5 N

Electrical specifications

Parameter	Min.	Nominal	Max.	Units
Operating voltage (V _{batt})	<ul style="list-style-type: none"> 17 	<ul style="list-style-type: none"> 24 	<ul style="list-style-type: none"> 34 	<ul style="list-style-type: none"> V
Idle current	-	<ul style="list-style-type: none"> 70 	-	<ul style="list-style-type: none"> mA at 24V
Quiescent current (power off)	-	-	<ul style="list-style-type: none"> 0.23 	<ul style="list-style-type: none"> mA at 24V



www.invacarelinx.com

Invacare Sales Companies

Australia:

Invacare Australia Pty. Ltd.
1 Lenton Place, North Rocks NSW
2151

Australia

Phone: 1800 460 460

Fax: 1800 814 367

orders@invacare.com.au

www.invacare.com.au

United Kingdom:

Invacare Limited

Pencoed Technology Park, Pencoed

Bridgend CF35 5AQ

Tel: (44) (0) 1656 776 222

Fax: (44) (0) 1656 776 220

uk@invacare.com

www.invacare.co.uk

Canada:

Invacare Canada L.P.
570 Matheson Blvd East, Unit 8
CDN Mississauga, On. L4Z 4G4

Phone: (905) 890 8300

Toll Free: 800.668.5324

www.invacare.ca

Eastern Europe, Middle East & CIS:

Invacare EU Export

Kleiststraße 49

D-32457 Porta Westfalica / Germany

Tel: (49) (0)57 31 754 540

Fax: (49) (0)57 31 754 541

webinfo-eu-export@invacare.com

www.invacare-eu-export.com

Ireland:

Invacare Ireland Ltd,
Unit 5 Seatown Business Campus
Seatown Road, Swords, County Dublin

Tel : (353) 1 810 7084

Fax: (353) 1 810 7085

ireland@invacare.com

www.invacare.ie

New Zealand:

Invacare New Zealand Ltd
4 Westfield Place, Mt Wellington 1060
New Zealand

Phone: 0800 468 222

Fax: 0800 807 788

sales@invacare.co.nz

www.invacare.co.nz

1637423-F 2019-03-28



Making Life's Experiences Possible®



Yes, you can.®