

# Invacare® LiNX IDC

en Remote  
User Manual

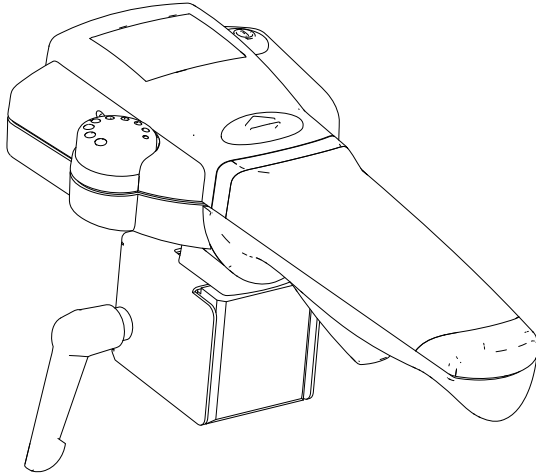

This manual **MUST** be given to the user of the product.  
**BEFORE** using this product, read this manual and save for future reference.



**Yes, you can.®**

© 2017 Invacare Corporation

All rights reserved. Reproduction, duplication or modification in whole or in part is prohibited without prior written permission from Invacare. Trademarks are identified by ™ and ®. All trademarks are owned by or licensed to Invacare Corporation or its subsidiaries unless otherwise noted.

Invacare reserves the right to alter product specifications without further notice.

---

# Contents

---

<b>1 General</b>	<b>4</b>
1.1 About this manual.	4
1.2 Intended use.	4
1.3 Service life	4
<b>2 Safety</b>	<b>5</b>
2.1 General safety notes	5
2.2 Safety information on IDC	5
<b>3 Components</b>	<b>6</b>
3.1 Top side	6
3.2 Bottom side	6
3.3 Labels on product	7
<b>4 Setup</b>	<b>9</b>
4.1 Installing/Removing the IDC.	9
4.2 Connecting IDC to controls system.	10
<b>5 Usage</b>	<b>11</b>
5.1 Starting up IDC	11
5.2 Switching control between attendant and occupant	11
5.3 Setting the speed	11
5.4 Controlling the wheelchair with IDC	12
5.4.1 How to steer the wheelchair	12
5.4.2 How the wheelchair reacts to handle movements	12
5.5 Information on the “Emergency Stop” function	13
5.6 Fault diagnosis	14
5.6.1 Fault codes and diagnosis codes.	14
<b>6 Maintenance</b>	<b>17</b>
6.1 IDC maintenance	17

---

## 1 General

---

### 1.1 About this manual

This document is a supplement to the power wheelchair's documentation.

The product itself does not bear a CE mark but is part of a product that complies with Directive 93/42/EEC concerning medical devices. It is therefore covered by the power wheelchair's CE marking. See the power wheelchair's documentation for more information.

For more information about the product, for example product safety notices and product recalls, contact your local Invacare representative. Before reading this manual, make sure you have the latest version. You find the latest version on the Invacare website. For address and website see back page of this manual.

### 1.2 Intended use

The IDC can be used to assign control of the power wheelchair from the occupant to an attendant. The IDC is not suitable for the wheelchair occupant himself. The attendant walks behind or to the side of the wheelchair, and can intuitively determine speed and direction of movement by pressing a handle with minimum force. Adjustments can also be made to the wheelchair using dedicated programming. Once the attendant activates the IDC, he takes over complete responsibility for the wheelchair and its occupant.

### 1.3 Service life

We estimate a service life of five years for this product, provided it is used in strict accordance with the intended use as set out in this document and all maintenance and service requirements are met. The estimated service life can be exceeded if the product is carefully used and properly maintained, and provided technical and scientific advances do not result in technical limitations. The service life can also be considerably reduced by extreme or incorrect usage. The fact that we estimate a service life for this product does not constitute an additional warranty.

## 2 Safety

### 2.1 General safety notes



#### **WARNING!**

##### **Risk of injury or damage due to electrical shorts**

Connector pins on cables connected to the power module can still be live even when the system is off.

- Cables with live pins should be connected, restrained or covered (with non-conductive materials) so that they are not exposed to human contact or materials that could cause electrical shorts.
- When cables with live pins have to be disconnected, for example, when removing the bus cable from the remote for safety reasons, make sure to restrain or cover the pins (with non-conductive materials).



##### **Risk of damage to the connector pins**

If you touch the connector pins, they can become dirty or they can be damaged by electrostatic discharge.

- Do not touch the connector pins.



##### **Risk of damage to the mobility device**

There are no user-serviceable parts inside any case.

- Do not open or disassemble any case.

### 2.2 Safety information on IDC



#### **CAUTION!**

##### **Risk of injury or damage**

Malfunctioning or unintended movement may occur if the IDC was exposed to forceful impacts such as wall collision or fall damage, or if it is visibly damaged. Internal parts might be broken.

- If unintended movement occurs, stop using the IDC and power wheelchair immediately and contact a qualified technician.



#### **CAUTION!**

##### **Risk of injury or damage**

If clamping lever or handle and housing screws are fitted too tightly or replaced by hardware not approved by Invacare, IDC internal parts might get damaged. This could lead to an unintended drive signal and the IDC could start running by itself when IDC is controlling the wheelchair.

- Do NOT tighten handle screws at all. Handle may get stuck or blocked.
- Tighten clamping lever and housing screws hand-tight only (max. 6 Nm).
- Tighten screw on monoblock to 1 Nm.
- Only use clamping lever and screws provided by Invacare for fixing IDC.
- Test mobility device before use.

## 3 Components

### 3.1 Top side

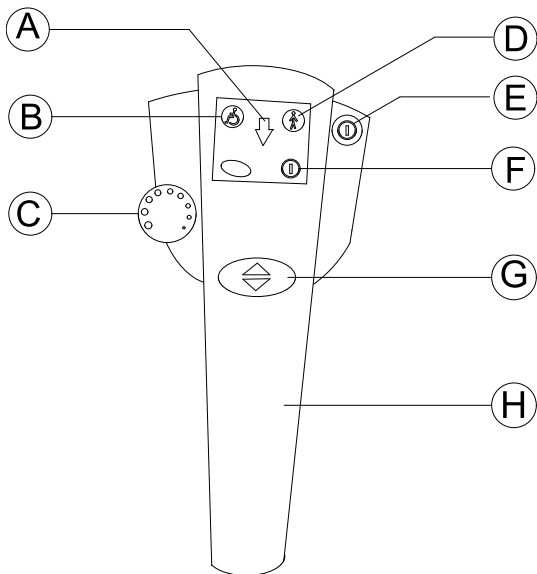

A “Reverse activated” LED

B “Wheelchair occupant in control” LED

C Speed potentiometer

D “Attendant in control” LED

E “Power button”

F Status LED

G “Forwards or reverse” push button

H Steering handle

### 3.2 Bottom side

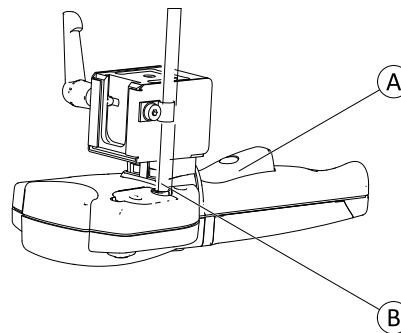

A Trigger lever for driving/emergency stop

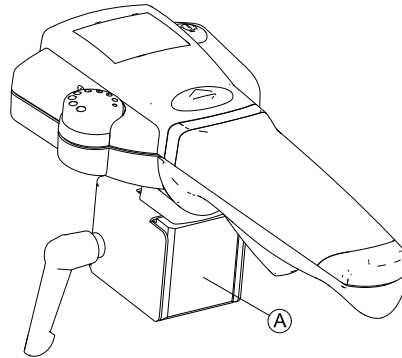

B Bus cable

### 3.3 Labels on product



<p>A</p>		<p>Product label containing:</p> <ul style="list-style-type: none"> <li>• Invacare logo</li> <li>• The product's serial number</li> <li>• The product's reference number</li> <li>• WEE symbol</li> <li>• Applied part symbol</li> <li>• Symbol of user manual</li> </ul>
----------	--	---

## Explanation of symbols on labels

	<p>This is the WEEE symbol (Waste Electrical and Electronic Equipment Directive).</p> <p>This product has been supplied from an environmentally aware manufacturer. This product may contain substances that could be harmful to the environment if disposed of in places (landfills) that are not appropriate according to legislation.</p> <ul style="list-style-type: none"> <li>• The 'crossed out wheeled bin' symbol is placed on this product to encourage you to recycle wherever possible.</li> <li>• Please be environmentally responsible and recycle this product through your recycling facility at its end of life.</li> </ul>
	<p>Type B Applied Part</p>
	<p>Recommendation to read the user manual before using the module.</p>



## 4 Setup

### 4.1 Installing/Removing the IDC

**!** **IMPORTANT!**  
**Risk of damage**

If an IDC is installed it will increase the footprint of the wheelchair. When driving without attendant, the IDC could get damaged, for example, when driving backwards against an obstacle.

- Remove or fold in the IDC before driving without attendant.

#### Installing the IDC

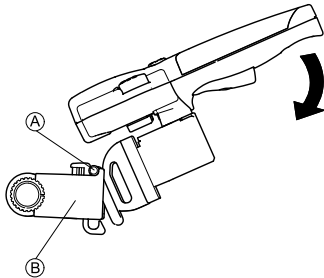

1. Position the adapter bracket (A) onto the KLiCKfix adapter (B).
2. Push the IDC downwards until it locks automatically.

#### Removing the IDC

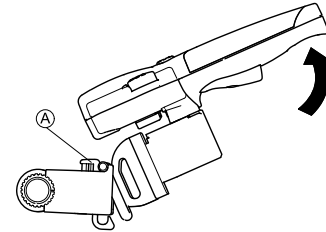

1. Press the red KLiCKfix button (A) and hold it.
2. Lift the IDC upwards to remove it from the adapter.

#### Folding in the IDC

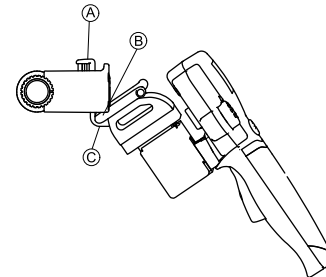

1. Remove the IDC from the adapter.
2. Press the red KLiCKfix button (A) and hold it.
3. Position the lower edge of the adapter bracket (B) inside the lower fixation of the adapter (C).
4. Release the KLiCKfix button.

## Preparing IDC for transport in a vehicle



### **WARNING!**

#### **Risk of injury and damage due to loose parts during transport**

For transport IDC with LiNX must be completely removed from power wheelchair and stored safely.

– Disconnect and take off IDC for transport.

1. Disconnect bus cable.
2. Press and hold KLICKfix button (A).
3. Take off IDC.
4. During transport of power wheelchair store IDC safely, for example in glove compartment.

## 4.2 Connecting IDC to controls system



The IDC takes over control of the wheelchair and may only be used by an attendant. It is imperative that the wheelchair occupant himself is not allowed to use the IDC.



Fitting should only be carried out by an Invacare provider. When fitting, ensure that the bus cable is routed and fixed correctly to avoid damage to the bus cable.

1. Power down wheelchair controls.
2. Connect one end of bus cable to IDC, other end to free bus socket on wheelchair.



In case there is no spare bus socket on controls system, you can order a 4-way bus socket from your Invacare provider.

3. The IDC is now connected to the controls.



For further information, see LiNX Service Manual.

## 5 Usage

### 5.1 Starting up IDC

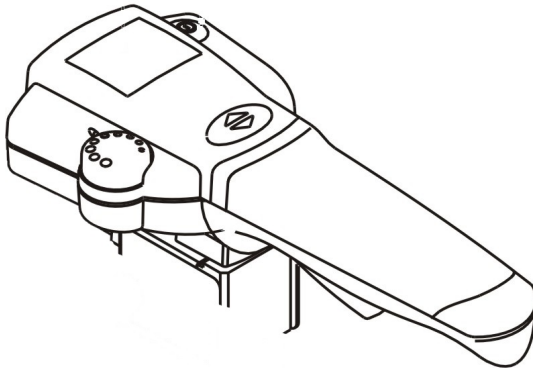

1. Connect IDC.
2. Power up power wheelchair.
3. If flash code appears, restart.
4. If flash code stays, check flash code.



If necessary, make firmware update of power wheelchair, install latest drive program, read error via LiNX Access iOS tool or PC tool.

### 5.2 Switching control between attendant and occupant

The remote that powers up the mobility device is in control of the wheelchair.

Pressing the power button on a remote not in control returns control from attendant to occupant and vice versa, unless other settings have been made.

### 5.3 Setting the speed

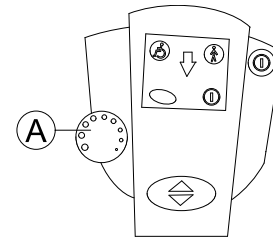

The maximum speed of the wheelchair can be set by the user to match his personal requirements and the surrounding conditions. The current maximum speed set is displayed on the wheelchair speed display **A** and can also be preset there. You can carry out further fine adjustments to the maximum speed on the IDC using the speed potentiometer.

1. Set maximum speed with speed potentiometer **A**.
2. Pull trigger lever to start driving.  
The more you pull, the faster the wheelchair drives until it reaches maximum speed.

## 5.4 Controlling the wheelchair with IDC

1. Press power button on IDC to switch on the wheelchair. The display on the remote illuminates. The wheelchair is ready to drive.
2. Set driving speed (speed potentiometer — see 5.3 *Setting the speed, page 11*).
3. Pull trigger lever to set wheelchair in motion.

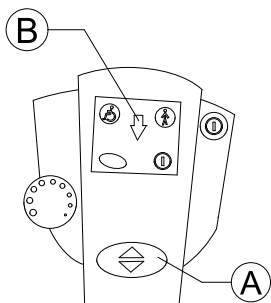



You can set whether the wheelchair should travel forwards or backwards by pressing the switchover button for forwards or reverse gear (A). If reverse gear has been selected, the arrow (B) illuminates.

 After a restart, the power wheelchair always drives forwards.

### 5.4.1 How to steer the wheelchair

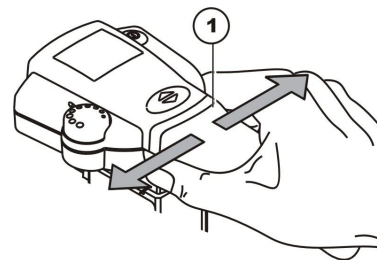
The electronic system contained in the handle (1) registers the movement made by the attendant's hand. Slight pressure on the handle to the left or right is translated into a drive command for the drive wheels so that bends can be travelled without the need for much force.



 Make yourself familiar with steering the wheelchair via IDC, so that no hazards are posed for the occupant or others.

### 5.4.2 How the wheelchair reacts to handle movements

You steer the wheelchair by pushing the handle to the sides. Whether you are travelling forwards or backwards, you must push the left-hand side of the handle to make the wheelchair turn to the left. If you push the right-hand side of the handle, the wheelchair will turn to the right.

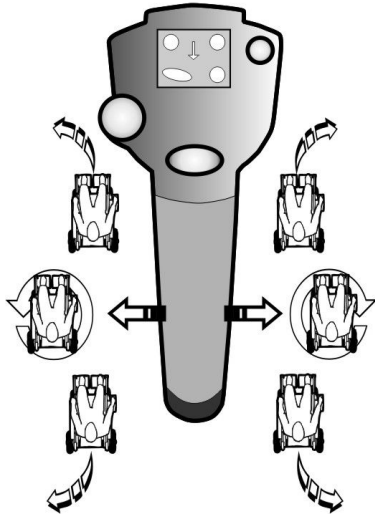

Travel direction

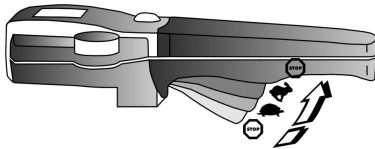

The more the trigger lever is pulled, the faster the wheelchair drives.

**i** To brake quickly, simply let go of the handle. The wheelchair brakes. If you pull the trigger lever with full force, the wheelchair carries out an "Emergency Stop".

## 5.5 Information on the "Emergency Stop" function

**i** When using Emergency stop function while driving, the wheelchair brakes harder, than when you just let go of the trigger lever.

There are three ways to emergency stop the mobility device.

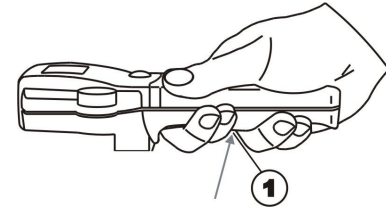

If the wheelchair needs to be stopped immediately due to a hazard situation, pull the trigger lever (1) firmly as far as possible. This causes an immediate forced drive switch-off. Once you release the trigger lever (1) and the attendant LED stops flashing, you can start to drive the wheelchair again immediately.

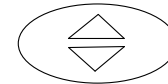

Alternatively, press "forwards or reverse" push button to stop the wheelchair. The attendant LED stops flashing and you can start to drive the wheelchair again immediately.

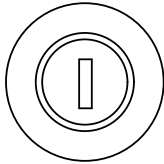

Or, press the power button. The wheelchair needs to power up, before you can drive the wheelchair again.

## 5.6 Fault diagnosis

If the electronic system shows a fault, use the following fault-finding guide to locate the fault.

### 5.6.1 Fault codes and diagnosis codes

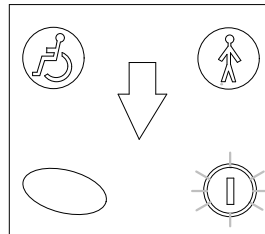

The status indicator is yellow when remote is active. If there is a fault detected by the LiNX system, the status indicator flashes yellow. The number of flashes indicates the type of fault.

The table below describes the fault indication, and a few possible actions that can be taken to rectify the problem. The actions listed are not in any particular order and are suggestions only. The intention is that one of the suggestions may help you solve the problem. If in doubt, contact your provider.



Ensure that the drive electronics system is powered up before starting any diagnosis.

#### If the status display is OFF:

- Check whether the drive electronics system is powered up.
- Check whether all cables are correctly connected.
- Ensure that the batteries are not discharged.

#### If a fault number is displayed in the status display:

- Proceed to the next section.

Flash code	Fault description	Possible action
1	Remote fault	<ul style="list-style-type: none"> <li>• Check cables and connectors.</li> <li>• Check other remotes, if installed.</li> <li>• Contact your provider.</li> </ul>
2	Network or configuration fault	<ul style="list-style-type: none"> <li>• Restart wheelchair.</li> <li>• Check cables and connectors.</li> <li>• Recharge the batteries.</li> <li>• Check charger.</li> <li>• Contact your provider.</li> </ul>
3	Motor 1 <sup>1</sup> fault	<ul style="list-style-type: none"> <li>• Check cables and connectors.</li> <li>• Contact your provider.</li> </ul>
4	Motor 2 <sup>1</sup> fault	<ul style="list-style-type: none"> <li>• Check cables and connectors.</li> <li>• Contact your provider.</li> </ul>
5	Motor 1 <sup>1</sup> magnetic brake fault	<ul style="list-style-type: none"> <li>• Check cables and connectors.</li> <li>• Check left magnetic brake is engaged.</li> <li>• Refer to the chapter “Pushing the mobility device in freewheel mode” in the user manual of your wheelchair.</li> <li>• Contact your provider.</li> </ul>
6	Motor 2 <sup>1</sup> magnetic brake fault	<ul style="list-style-type: none"> <li>• Check cables and connectors.</li> <li>• Check right magnetic brake is engaged.</li> <li>• Refer to the chapter “Pushing the mobility device in freewheel mode” in the user manual of your wheelchair.</li> <li>• Contact your provider.</li> </ul>
7	Module fault (other than remote module)	<ul style="list-style-type: none"> <li>• Check cables and connectors.</li> <li>• Check modules.</li> <li>• Recharge batteries.</li> <li>• If the chair was stalled, reverse away or remove obstacle.</li> <li>• Contact your provider.</li> </ul>

1 Configuration of the motors depending on the wheelchair model

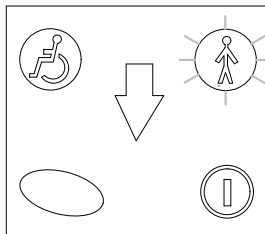

The attendant in control LED is green when IDC is in charge. If there is a fault detected by the LiNX system, the attendant in control LED flashes green.

Flash code	Fault description	Possible action
Flashing constantly	OON	Release trigger lever. If fault code stays: <ul style="list-style-type: none"> <li>• Do not use IDC. Replace IDC.</li> <li>• Contact your provider.</li> </ul>



## 6 Maintenance

### 6.1 IDC maintenance

General information about maintaining and cleaning remote and power wheelchair are described in the user manual of the power wheelchair.

#### Inspection checks

The following table lists inspection checks that should be performed by the user and their intervals. If the mobility device fails to pass one of the inspection checks, refer to the chapter indicated or contact your authorized Invacare provider. A more comprehensive list of inspection checks and instructions for maintenance work can be found in the service manual for the corresponding wheelchair, which can be obtained from Invacare. That manual, however, is intended to be used by trained and authorized service technicians, and describes tasks which are not intended to be performed by the user.

<b>Before each use of the power wheelchair with IDC</b>		
<b>Item</b>	<b>Inspection check</b>	<b>If inspection is not passed</b>
IDC	Check for damage and wear.	Check all functionalities below. If unsure, contact your provider.
IDC	Check if trigger lever for driving / emergency stop is completely released.	Immediately stop using the IDC. Contact your provider.
IDC	Check emergency stop functions.	Immediately stop using the IDC. Contact your provider.
IDC	Check power button for correct functionality.	Contact your provider.
IDC	Check of correct operating mode for all LED flash lights.	Contact your provider.

<b>Before each use of the power wheelchair with IDC</b>		
<b>Item</b>	<b>Inspection check</b>	<b>If inspection is not passed</b>
Electronics and connectors	Check all cables for damage and all connecting plugs for snug fit.	Contact your provider.
Housing	Check IDC housing for loose parts.	If there is a rattling noise, when you shake it: Immediately stop using the IDC. Replace IDC. Contact your provider.



## Invacare Sales Companies

### Australia:

Invacare Australia PTY. Ltd.  
1 Lenton Place, North Rocks NSW  
2151  
Australia  
Phone: 1800 460 460  
Fax: 1800 814 367  
orders@invacare.com.au  
www.invacare.com.au

### United Kingdom:

Invacare Limited  
Pencoed Technology Park, Pencoed  
Bridgend CF35 5AQ  
Tel: (44) (0) 1656 776 222  
Fax: (44) (0) 1656 776 220  
uk@invacare.com  
www.invacare.co.uk

### Canada:

Invacare Canada LP  
570 Matheson Blvd E. Unit 8  
Mississauga Ontario  
L4Z 4G4, Canada  
Phone: (905) 890 8300  
Fax: (905) 501 4336

### Eastern Europe, Middle East & CIS:

Invacare EU Export  
Kleiststraße 49  
D-32457 Porta Westfalica / Germany  
Tel: (49) (0)57 31 754 540  
Fax: (49) (0)57 31 754 541  
webinfo-eu-export@invacare.com  
www.invacare-eu-export.com

### Ireland:

Invacare Ireland Ltd,  
Unit 5 Seatown Business Campus  
Seatown Road, Swords, County Dublin  
Tel : (353) 1 810 7084  
Fax: (353) 1 810 7085  
ireland@invacare.com  
www.invacare.ie

### New Zealand:

Invacare New Zealand Ltd  
4 Westfield Place, Mt Wellington 1060  
New Zealand  
Phone: 0800 468 222  
Fax: 0800 807 788  
sales@invacare.co.nz  
www.invacare.co.nz

1643411-A 2017-11-07



**Making Life's Experiences Possible®**



**Yes, you can.®**