

Invacare® Pronto™ M41 Series



en Power Wheelchair
Service Manual



PROVIDER: Keep this manual.
The procedures in this manual MUST be performed by a qualified technician.



Yes, you can.

© 2019 Invacare® Corporation

All rights reserved. Republication, duplication or modification in whole or in part is prohibited without prior written permission from Invacare. Trademarks are identified by ™ and ®. All trademarks are owned by or licensed to Invacare Corporation or its subsidiaries unless otherwise noted.

Invacare reserves the right to alter product specifications without further notice.

Making Life's Experiences Possible is a registered trademark in the U.S.A.

Contents

1 General	4
1.1 About this Manual	4
1.2 General Information	4
1.3 Notes on Shipping	4
1.4 Symbols in This Manual	4
1.5 Images in This Manual	4
2 Safety	5
2.1 Safety and Fitting Instructions	5
3 Hygiene	7
3.1 Handling of Returned Used Products	7
4 Setup	8
4.1 Adjusting Seating Position	8
4.2 Adjusting Lower Leg Length	8
4.3 Adjusting Seat Depth	8
4.3.1 Adjusting Seat Position on Seat Base	9
4.4 Adjusting Seat Height (Captain's Seat and Standard Seat)	11
4.5 Adjusting Seat Height (Modulite)	11
4.6 Adjusting Seat Angle (Modulite)	12
4.7 Adjusting Centre of Gravity of Seat	13
5 Testing	15
5.1 Testing Motor	15
5.2 Testing Motor Brake	15
5.3 Rain test	15
5.4 Field Load Test	16
5.5 Checking Battery Charge Level	16
6 Service	18
6.1 General warning information on installation work	18
6.2 Tightening torques	18
6.3 Imperial to metric conversion chart	18
6.4 Troubleshooting	20
6.4.1 Operational Faults	20
6.4.2 Drive Fault Diagnosis	20
6.4.3 Charging device fault diagnosis	22
6.5 Service Plan (Once a Year)	23
6.6 Overview	24
6.7 Moving Seat into Service Position (Modulite)	25
6.8 Drive Components	26
6.8.1 Replacing Motor	26
6.8.2 Replacing Swingarm Assembly	26
6.8.3 Replacing Spring	27
6.8.4 Replacing Forks and/or Castor Assemblies	27
6.8.5 Adjusting Forks	28
6.9 Wheels	29
6.9.1 Repair Instructions	29
6.9.2 Tyre Pressure	29
6.9.3 Tyre Types	29
6.9.4 Specific Tightening Torques	30
6.9.5 Overview of Power Wheelchair Models and Wheel Types	30
6.9.6 Replacing Drive Wheel (1-Bolt Installation)	32
6.9.7 Replacing Castor Wheel on Double-Sided Fork	33
6.10 Shrouds	36
6.10.1 Replacing Top Shroud	36
6.10.2 Replacing Front Shroud	36
6.10.3 Replacing Rear Shroud	37
6.11 Controls	37
6.11.1 Replacing Power Module	37
6.11.2 Checking Actuator	38
6.11.3 Updating Software	38
6.11.4 Drive Program Selection After Component Replacement	39
6.11.5 Cable Routing	39
6.11.6 Checking Cables	39
6.12 Batteries	40
6.12.1 General Instructions on Handling Batteries	40
6.12.2 Handling Damaged Batteries Correctly	40
6.12.3 Using Proper Batteries	41

6.12.4 Connecting/Disconnecting Battery Cables	41
6.12.5 Replacing Batteries	43
7 Seating	45
7.1 Replacing Seat Assembly	45
7.2 Adjusting Sling Backrest (Standard Seat)	45
7.3 Replacing Backrest (Standard Seat)	46
7.4 Replacing Armrest (Captain's Seat)	46
7.5 Replacing Armrest Assembly (Captain's Seat)	47
7.6 Replacing Postural Belt (Standard Seat)	47
7.7 Replacing Postural Belt (Captain's Seat)	47
7.8 Replacing Footboard Assembly	48

1 General

1.1 About this Manual

- For more information about Modulite seat system, see the Modulite service manual.
- For more information about LiNX controls, see the LiNX service manual.
- For for more information about Shark and ACS electronics, see revision 2 of this service manual.

1.2 General Information

Service and maintenance work must be carried out taking this document into account.

It is imperative that you observe safety information.

Information about operation or about general maintenance and care work on the product should be taken from service manual.

Assembly of accessories might not be described in this document. Refer to the manual delivered with the accessory. Additional manuals can be ordered from Invacare. See addresses at the end of this document.

You can find information about ordering spare parts in the spare parts catalogue.

Spare parts must match original Invacare parts. Only use spare parts which have been approved by Invacare.

The product may only be maintained and overhauled by qualified personnel.

The minimum requirement for service technicians is suitable training, such as in the cycle or orthopedic mechanics fields, or sufficiently long-term job experience. Experience in the use of electrical measuring equipment (multimeters) is also a requirement. Special Invacare training is recommended.

Alterations to the mobility device which occur as a result of incorrectly or improperly executed maintenance or overhaul work lead to the exclusion of all liability on the side of Invacare.

If you have any problems or questions contact your provider.

1.3 Notes on Shipping

- If the mobility device has to be shipped back to the manufacturer for major repairs, you should always use the original packaging for transport.
- Please attach a precise description of the fault.

1.4 Symbols in This Manual

Symbols and signal words are used in this manual and apply to hazards or unsafe practices which could result in personal injury or property damage. See the information below for definitions of the signal words.



WARNING

Indicates a hazardous situation that could result in serious injury or death if it is not avoided.



CAUTION

Indicates a hazardous situation that could result in minor or slight injury if it is not avoided.



IMPORTANT

Indicates a hazardous situation that could result in damage to property if it is not avoided.



Tips

Gives useful tips, recommendations and information for efficient, trouble-free use.



Tools

Identifies required tools, components and items which are needed to carry out certain work.

1.5 Images in This Manual

The detailed images in this manual are given marks to identify various components. Component marks in text and operational instructions always relate to the image directly above.

2 Safety

2.1 Safety and Fitting Instructions

These safety instructions are intended to prevent accidents at work, and it is imperative that they are observed.

Before any inspection or repair work

- Read and observe this repair manual and the associated user manual.
- Observe the minimum requirements for carrying out the work (see 1.2 *General Information, page 4*).

Personal Safety Equipment

Safety shoes

The mobility device, and some of its components, are very heavy. These parts can result in injuries to the feet if they are allowed to drop.

- Wear standardized safety shoes during all work.

Eye protection

It is possible that battery acid can be discharged when working on defective batteries or when handling batteries improperly.

- Always wear eye protection when working on any defective or possibly defective batteries.

Safety gloves

It is possible that battery acid can be discharged when working on defective batteries or when handling batteries improperly.

- Always wear acid-proof safety gloves when working on any defective or possibly defective batteries.

General Safety Information and Information About Fitting / Removal



DANGER!

Risk of Death, Serious Injury, or Damage

Lighted cigarettes dropped onto an upholstered seating system can cause a fire resulting in death, serious injury, or damage. Mobility device occupants are at particular risk of death or serious injury from these fires and resulting fumes because they may not have the ability to move away from the mobility device.

- DO NOT smoke while using this mobility device.



WARNING!

Risk of Serious Injury or Damage

Storing or using the mobility device near open flame or combustible products can result in serious injury or damage.

- Avoid storing or using the mobility device near open flame or combustible products.



CAUTION!

Risk of crushing

Various components such as the drive unit, batteries, seat etc are very heavy. This results in injury hazards to your hands.

- Note the high weight of some components. This applies especially to the removal of drive units, batteries and the seat.



CAUTION!

Injury hazard if the mobility device starts moving unintentionally during repair work

- Switch the power supply off (ON/OFF key).
- Engage the drive.
- Before lifting up, secure the mobility device by using chocks to block the wheels.



CAUTION!

Fire and burn hazard due to electrical short-circuit

– The mobility device must be completely switched off before removal of voltage-carrying components! To do this, remove the batteries.

- Avoid short-circuiting the contacts when carrying out measurements on voltage-carrying components.



CAUTION!

Risk of burns from hot surfaces on the motor

- Allow the motors to cool down before commencing work on them.



CAUTION!

Injury hazard and risk of damage to mobility device due to improper or incomplete maintenance work

- Use only undamaged tools in good condition.
- Some moving parts are mounted in sockets with PTFE coating (Teflon™). Never grease these sockets!
- Never use "normal" nuts instead of self-locking nuts.
- Always use correctly-dimensioned washers and spacers.
- When reassembling, always replace any cable ties which were cut during dismantling.
- After completing your work / before renewed start-up of the mobility device, check all connections for tight fitting.
- After completing your work / before renewed start-up of the mobility device, check all parts for correct locking.
- Only operate the mobility device with the approved tyre pressures (see technical data).
- Check all electrical components for correct function. Note that incorrect polarity can result in damage to the control system.
- Always carry out a trial run at the end of your work.



CAUTION!

Risk of injury and damage to property, if the maximum speed reduction on a wheelchair with a lifter does not function correctly

The wheelchair's control unit must reduce the maximum possible speed as soon as the lifter is raised.

- Test the maximum speed reduction for correct function after any maintenance work or modifications to the wheelchair.



CAUTION!

Any changes to the drive program can affect the driving characteristics and the tipping stability of the mobility device

- Changes to the drive program may only be carried out by trained Invacare providers.
- Invacare supplies all mobility devices with a standard drive program ex-works. Invacare can only give a warranty for safe mobility device driving behavior - especially tipping stability - for this standard drive program.



Mark all current settings for the mobility device (seat, armrests, backrest etc.), and the associated cable connecting plugs, before dismantling. This makes reassembly easier. All plugs are fitted with mechanical locks which prevent release of the connecting plugs during operation. To release the connecting plugs the safety locks must be pressed in. When reassembling ensure that these safety locks are correctly engaged.

3 Hygiene

3.1 Handling of Returned Used Products

When reconditioning or repairing returned mobility devices:

- Take precautions for yourself and the product.
- Use protection equipment as specified locally.

Before Transport (According to Biological Agents Ordinance)

Treat product according to following process steps:

Process Step	Component	Application	Conditioning technique	Work Station
Manual cleaning	Surface of used device	Before repair or reconditioning	Use saturated towel to apply cleaning detergent and remove residues after impact.	Cleaning and disinfection
Disinfection	Surface of used device	Before repair or reconditioning	Use saturated disinfectant wipes and clean* the device surface.	Cleaning and disinfection

*Invacare uses detergent "Nücosept special" 1.5% in water ml/ml

Disinfection Tools

- Disposable wipes (fleece)
- Brushes to clean areas difficult to access

Further Information

 For more information contact your Invacare service department.

4 Setup

4.1 Adjusting Seating Position

To adapt the mobility device optimally to the requirements of the user, we recommend that you ask your authorised Invacare provider to adjust the seat depth individually. Adapting the seat to the user's seating position depends on which seat has been fitted, and should be carried out in the following sequence.

1. Adjusting lower leg length, see *4.2 Adjusting Lower Leg Length, page 8*.
2. Adjusting seat depth, see *4.3 Adjusting Seat Depth, page 8*.
3. Adjusting seat height, see *4.4 Adjusting Seat Height (Captain's Seat and Standard Seat), page 11* and *4.5 Adjusting Seat Height (Modulite), page 11*.
4. Adjusting seat angle, see *4.6 Adjusting Seat Angle (Modulite), page 12*.
5. Adjusting centre of gravity of seat frame, see *4.7 Adjusting Centre of Gravity of Seat, page 13*.
6. Repetition of steps 3 to 4, if necessary.



WARNING!

Risk of injury by tipping of mobility device caused by blocked castors.

- Always check seat depth settings for both forward and reverse movement.
- Make sure that castors can rotate freely and have no contact to any fixed mobility device component.



Any changes to the drive program can affect the driving characteristics and the tipping stability of the vehicle!

- Changes to the drive program may only be carried out by trained Invacare specialist providers.
- Invacare supplies all mobility aids with a standard drive program ex-works. Invacare can only give a warranty for safe vehicle driving behaviour - especially tipping stability - for this standard drive program.



CAUTION!

Risk of crushing

- The seat is very heavy. Risk of injury to hands and feet.
- Pay attention to the hand and feet.
 - Use proper lifting techniques.

4.2 Adjusting Lower Leg Length

Invacare offers a range of legrests which can be adjusted individually. See user manual.

4.3 Adjusting Seat Depth

Pay attention to centre of gravity of seat. The seat can be adjusted by mounting seat frame farther towards front or rear on seat, see *4.7 Adjusting Centre of Gravity of Seat, page 13*.

Captain's Seat



- Phillips screwdriver

1. Remove seat, see 7.1 Replacing Seat Assembly, page 45.
2. Remove seat base (3) from seat assembly, see 4.3.1 Adjusting Seat Position on Seat Base, page 9.
3. Remove six mounting screws (5) located under seat that secure seat back assembly (1) in place.

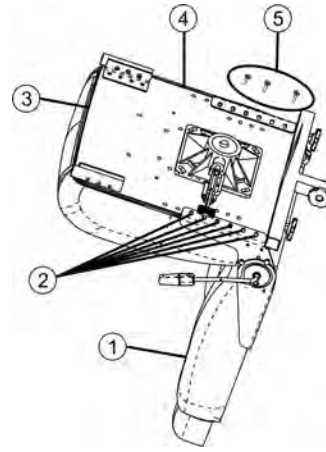

Fig. 4-1

4. Adjust seat back (1) assembly to desired position and reinstall six mounting screws (5). Securely tighten.



For proper seat depth positions, see "Detail A". For example, to achieve maximum seat depth, front mounting hole (2) on seat back bracket (4) aligns with third hole on seat base (3).

Min. seat depth:	Middle seat depth:	Max. seat depth:
16 inch (406.4 mm)	17 inch (431.8 mm)	18 inch (457.2 mm)

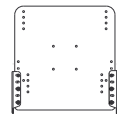
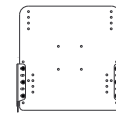
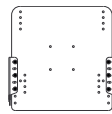

Fig. 4-2 Detail "A"

5. Install seat base (3) onto seat assembly, see 4.3.1 Adjusting Seat Position on Seat Base, page 9.
6. Reinstall seat.

Modulite Seat



- 6 mm Allen key

1. Remove seat plate or sling seat, see Modulite service manual.
2. Loosen socket head screws (2) in front and rear, left and right – DO NOT remove.
3. Shift position of seat.
4. Tighten screws.
5. Install seat plate or sling seat again.

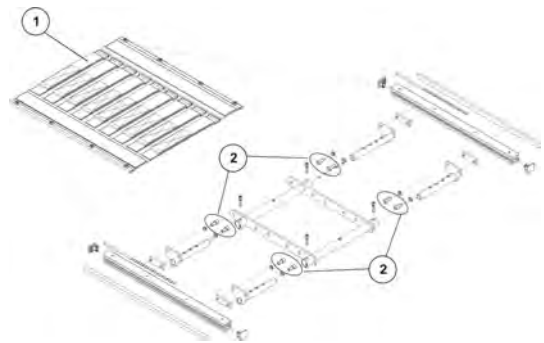

Fig. 4-3

4.3.1 Adjusting Seat Position on Seat Base



See table below for proper seat post mounting positions (1). For users over 220 lbs (100 kg) the seat must be in the 1-inch (25.4 mm) back position when using seat post mounting holes 3, 4 and 5. See 4.4 Adjusting Seat Height (Captain's Seat and Standard Seat), page 11.

1. Remove seat. See 7.1 Replacing Seat Assembly, page 45.
2. Remove four mounting screws (4) and washers (3) securing the seat pivot to seat base (2).
3. Separate seat pivot from seat base.

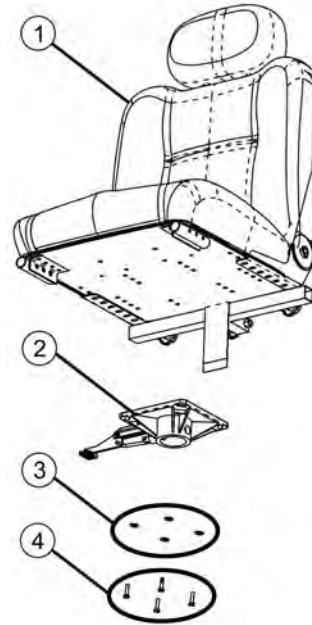

Fig. 4-4

4. See following list to determine correct mounting holes to achieve desired seat position.
 - (5) 1-inch (25.4 mm) back seat position
 - (6) Standard seat position
 - (7) 1-inch (25.4 mm) forward seat position¹
 - (8) 1-inch (25.4 mm) back seat position
 - (9) Standard seat position
 - (10) 1-inch (25.4 mm) forward seat position¹
5. Align mounting holes on seat pivot with mounting holes on seat base.
6. Secure seat base to seat assembly using four mounting screws and washers. Securely tighten.
7. Install seat.

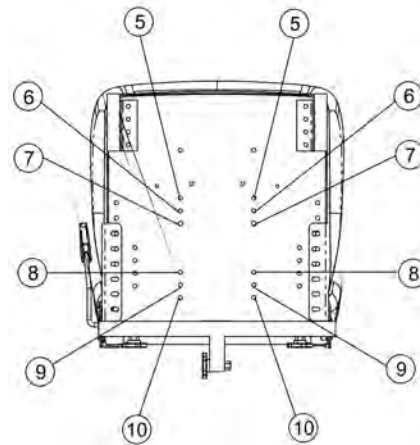

Fig. 4-5

¹ For users over 220 lbs (100 kg) - do not use 1-inch (25.4 mm) forward position.

Proper Seat Positions for 18-Inch (457.2 mm) Deep Back Setting

Weight Limitation	Seat Post Mounting Hole	1-Inch (25.4 mm) Back	Standard	1-Inch (25.4 mm) Forward
300 lbs (136 kg)	1	Y	Y	N/A
	2	Y	Y	N/A
	3	Y	N/A	N/A
	4	Y	N/A	N/A
	5	Y	N/A	N/A
220 lbs (100 kg)	1	Y	Y	Y
	2	Y	Y	N/A
	3	Y	N/A	N/A
	4	Y	N/A	N/A
	5	Y	N/A	N/A

Weight Limitation	Seat Post Mounting Hole	1-Inch (25.4 mm) Back	Standard	1-Inch (25.4 mm) Forward
150 lbs (68 kg)	1	Y	Y	Y
	2	Y	Y	Y
	3	Y	Y	Y
	4	Y	Y	Y
	5	Y	Y	Y

Legend: Y - Use N/A - Do not use

4.4 Adjusting Seat Height (Captain's Seat and Standard Seat)

 The seat can be adjusted to five height positions in 1-inch (25.4 mm) increments.

 For more information about the proper seat post mounting positions (1), see *4.3 Adjusting Seat Depth, page 8*. For users over 220 lbs (100 kg) the mounting holes 3, 4 and 5 must be used with the seat in the 1-inch (25.4 mm) back position. See *4.3.1 Adjusting Seat Position on Seat Base, page 9*.



- 3/8 inch Allen key

1. Remove seat. See *7.1 Replacing Seat Assembly, page 45*.
2. Remove mounting screw (2) that secures seat post (4) to support tube (3).
3. Adjust seat post (4) to desired mounting position.
4. Reinstall mounting screw (2). Securely tighten.
5. Reinstall seat.

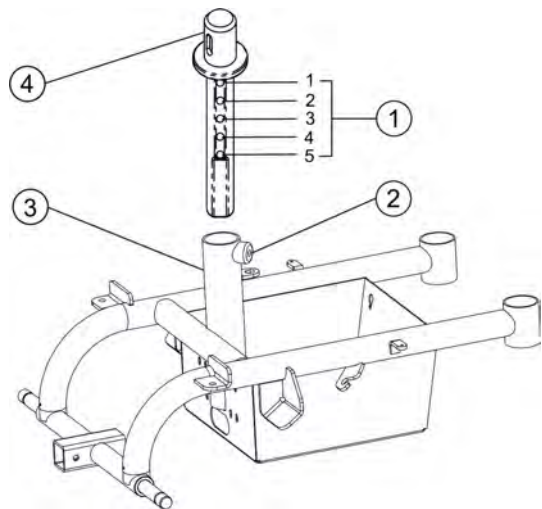

Fig. 4-6

4.5 Adjusting Seat Height (Modulite)



- 13 mm wrench

1. Remove seat plate or sling seat. See Modulite service manual.
2. Loosen and remove screws (3) and self-locking nuts (1) in front and rear (2).

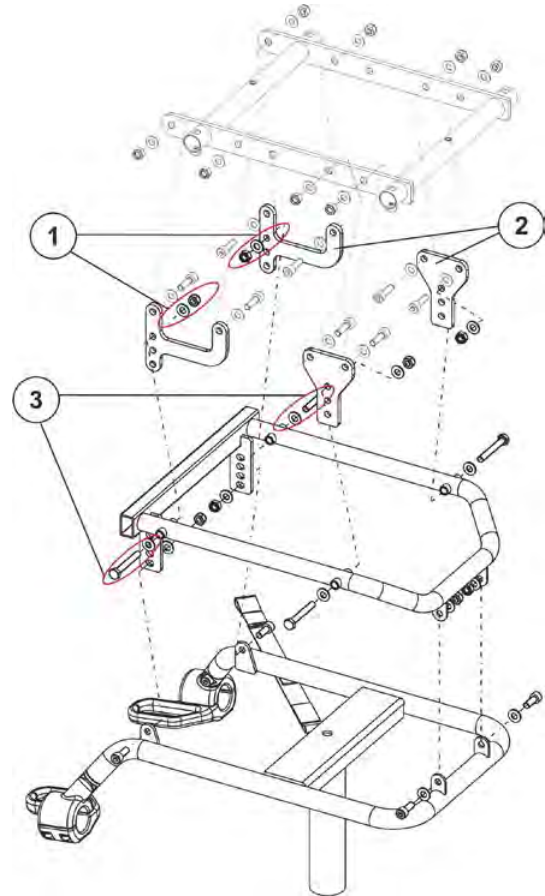

Fig. 4-7

3. Adjust seat frame (2) to desired mounting position (a, b or c). See table *Seat Height* for different seat height values.
4. Refit screws and self-locking nuts.
5. Install seat plate or sling seat.

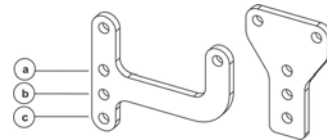



Fig. 4-8

Seat height		
Mounting position	Seat plate	Sling seat
a	450 mm	480 mm
b	470 mm	500 mm
c	490 mm	520 mm

4.6 Adjusting Seat Angle (Modulite)

-  • 6 mm Allen key
-  • 13 mm wrench

1. Remove seat plate or sling seat. See Modulite service manual.
2. Loosen and remove screws (4) and self-locking nuts (2) including washers (2).

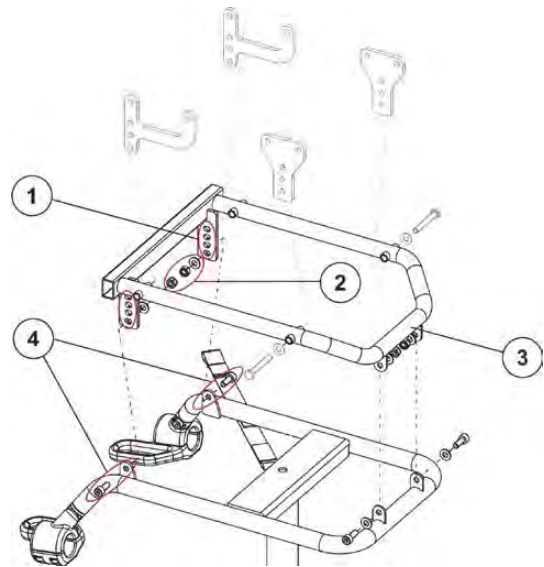

Fig. 4-9

3. Choose desired hole (1) to adjust seat angle with seat frame (3).
 - (a) 0°
 - (b) 2°
 - (c) 4°
 - (d) 6°
4. Refit screws and self-locking nuts including washers.
5. Adjust seat height if necessary. See 4.5 *Adjusting Seat Height (Modulite)*, page 11.
6. Install seat plate or sling seat.

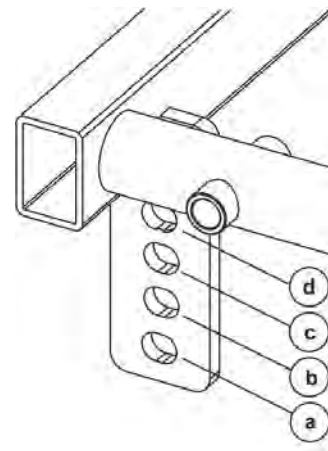

Fig. 4-10

4.7 Adjusting Centre of Gravity of Seat

The centre of gravity of the seat can be adjusted by mounting the seat frame farther towards the front or the rear on the seat.

- !** The seating system of the mobility device is delivered ex works with an optimally adjusted centre of gravity. Any change in this adjustment setting can negatively influence the stability of the mobility device.
- You must perform an individual risk analysis every time you change the centre of gravity of the seating position, in order to ensure the safety and stability of the power wheelchair.

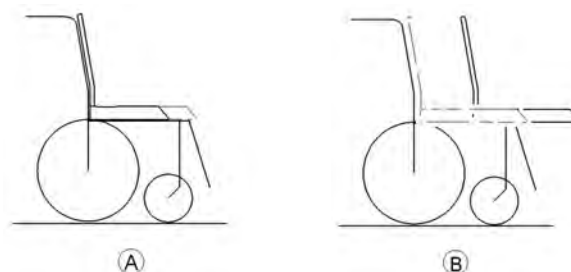

Fig. 4-11

- Ⓐ Seat depth
- Ⓑ Centre of gravity of the seat/ seat position

i The user weight and seat depth have strong influences on the choice of the centre of gravity of the seat. If the user is heavy and the seat depth is greater, the focus should be the farther back.

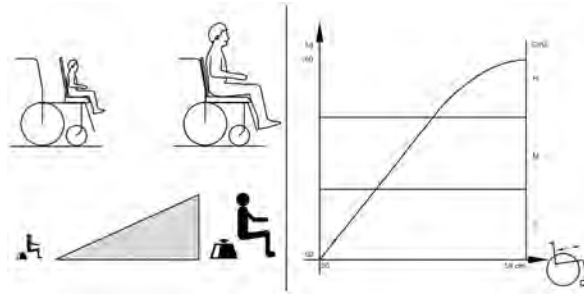



Fig. 4-12

For best possible driving characteristics of rear-wheel drive wheelchairs, the weight to be distributed: 30 – 40 % front and 60 - 70 % rear.

5 Testing

5.1 Testing Motor

-  • Phillips screwdriver, size 2
-  • Digital multimeter with resistance measurement

1. Remove shroud that covers power module. See 6.10 *Shrouds, page 36*.
2. Unplug cable of motor (A) from power module.
3. Connect multimeter (B) to motor plug contacts (C) and (D) and measure resistance between contacts.

 A resistance of between 0.5 ohms and 10 ohms indicates a motor ready for operation. A resistance of between 15 ohms and infinity indicates a defective motor. High resistances are normally caused by bad connections or worn carbon brushes.

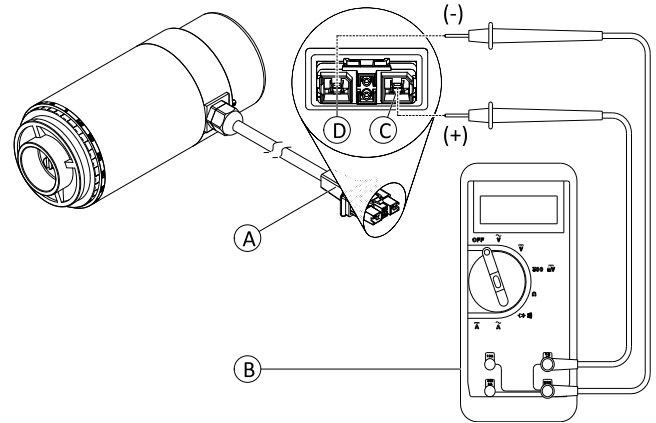



Fig. 5-1 DuraWatt motor serves as an example.

5.2 Testing Motor Brake

 This test should only be carried out on mobility device with conventional motor-gearbox units.





CAUTION!

Risk of damage to power module due to shorts in motor brake

- NEVER connect a shorted motor brake to an intact power module.
- Always replace shorted brakes immediately.

 A defective motor can damage the power module, but a defective power module cannot damage the motor.

-  • Phillips screwdriver, size 2
-  • Digital multimeter with resistance measurement

1. Remove shroud that covers power module. See 6.10 *Shrouds, page 36*.
2. Unplug cable of motor (A) from power module.
3. Connect multimeter (B) to motor plug contacts (E) and (F) and measure resistance between contacts.

 A resistance of between 40 ohms and 80 ohms indicates an intact brake. A resistance of 0 ohms or a very high resistance (mega-ohms or infinity) indicates a short-circuit, a bad connection or a defective brake.

4. If there is a defect, replace motor and send it to Invacare Service for inspection or repair.

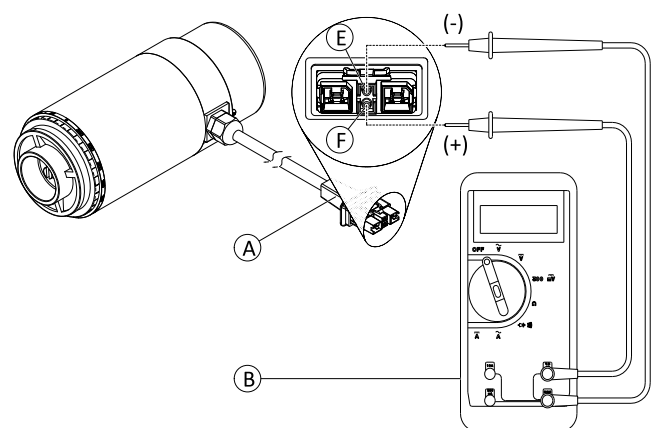



Fig. 5-2 DuraWatt motor serves as an example.

5.3 Rain test

- Check to ensure that the black battery terminal caps are secured in place, gaiter is not torn or cracked where water can enter and that all electrical connections are secure at all times.
- Do not use the mobility device if the gaiter is torn or cracked. If the gaiter becomes torn or cracked, replace immediately.

5.4 Field Load Test

Old batteries lose their ability to store and release power due to increased internal resistance. In this procedure, batteries are tested under load using a digital voltmeter to check battery charge level at the charger connector. The charger connector is located on the remote. When voltage at the output drops 1.0 volts under load (2.0 volts for a pair), replace the batteries.

 Read these instructions carefully and the manufacturer’s instructions on the digital voltmeter before proceeding.

-  • Voltmeter



WARNING!

– When performing the following steps, ensure your feet are clear from casters and wall, otherwise injury may result.

1. Switch electronics OFF on remote.
2. Make sure battery is fully charged. An extremely discharged battery will exhibit the same symptoms as a bad battery.
3. Remove footboard/legrests from mobility device.
4. Connect voltmeter leads to charger connector **A** on mobility device. Most digital voltmeters **B** are not affected by polarity. However, analog meters (meters with swinging needles) can be and should be used carefully.

 A good meter reading should be 25.5 VDC to 26.0 VDC with the chair in neutral.

5. Switch electronics ON on remote.
6. Ensure that your feet are clear from casters and wall.
7. Run mobility device in neutral for at least 2 minutes.
8. Sit in mobility device and place your feet against a door jam, workbench or other stationary object.
9. Carefully give forward command, trying to drive the mobility device through the stationary object. The load should draw between 30 amps to 40 amps from the batteries for 0.3 seconds.

 Performing this step puts a heavy load on the batteries as they try to push through the stationary object. If the wheels spin, have two individuals (one on each arm) apply as much downward pressure as possible on the arms of the mobility device.

10. Read meter while motors are straining to determine voltage under load.

 If the voltage drops more than 2.0 volts from a pair of fully charged batteries during the 0.3 seconds, they should be replaced regardless of the unloaded voltages.

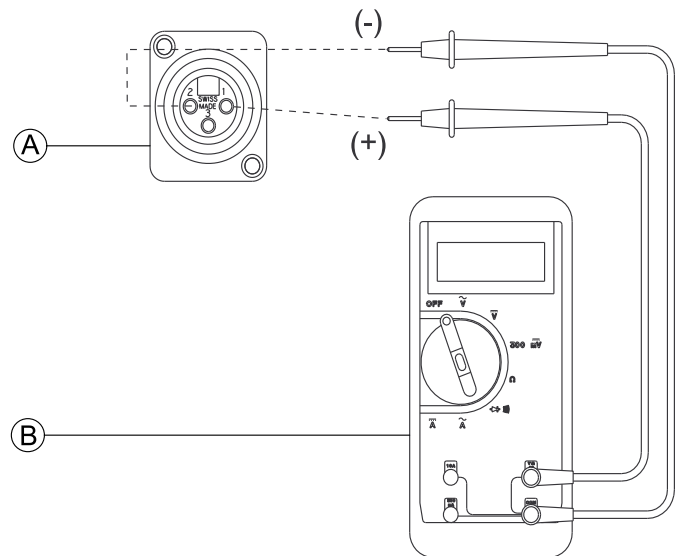

Fig. 5-3

5.5 Checking Battery Charge Level

The following “Dos” and “Don’ts” are provided for your convenience and safety.

DON'T	DO
Don't perform any installation or maintenance without first reading this manual.	Read and understand this manual and any service information that accompanies a battery and charger before operating the personal transporter.
Don't perform installation or maintenance of batteries in an area that could be damaged by battery spills.	Move the personal transporter to a work area before cleaning terminals, or opening battery box.
Don't make it a habit to discharge batteries to the lowest level.	Recharge as frequently as possible to maintain a high charge level and extend battery life.

DON'T	DO
Don't use chargers or batteries that are not appropriate for the chair.	Follow recommendations in this manual when selecting a battery or charger.
Don't put new batteries into service before charging.	Fully charge a new battery before using.
Don't tip or tilt batteries.	Use a carrying strap to remove, move or install a battery.
Don't tap on clamps and terminals with tools.	Push battery clamps on the terminals. Spread clamps wider if necessary.

6 Service

6.1 General warning information on installation work

CAUTION!

Risk of injury and damage to property, if the maximum speed reduction on a mobility device with a lifter does not function correctly

The mobility device's control unit must reduce the maximum possible speed as soon as the lifter is raised.

- Test the maximum speed reduction for correct function after any maintenance work or modifications to the mobility device.

6.2 Tightening torques

CAUTION!

Damage can be caused to the mobility device due to improperly tightened screws, nuts or plastic connections.

- Always tighten screws, nuts etc to the stated tightening torque.
- Only tighten screws or nuts which are not listed here fingertight.

The tightening torques stated in the following list are based on the thread diameter for the nuts and bolts for which no specific values have been determined. All values assume dry and de-greased threads.

Thread	Tightening torque in Nm $\pm 10\%$
M4	3 Nm
M5	6 Nm
M6	10 Nm
M8	25 Nm
M10	49 Nm
M12	80 Nm
M14	120 Nm
M16	180 Nm

UNC Thread	Tightening torque in Nm $\pm 10\%$
1/4"-20	11–7 Nm
5/16"-20	22–14 Nm
3/8"-16	41–25 Nm
7/16"-14	67–40 Nm
1/2"-13	100–60 Nm
9/16"-12	150–90 Nm
5/8"-11	210–130 Nm
3/4"-1	370–230 Nm
7/6"-9	600–370 Nm
1"-8	900–550 Nm

6.3 Imperial to metric conversion chart

You can use this chart as an orientation to find the right tool size.

IMPERIAL	METRIC
inch	mm
5/64	1.9844
3/32	2.3813
7/64	2.7781
1/8	3.1750

IMPERIAL	METRIC
inch	mm
9/64	3.5719
5/32	3.9688
11/64	4.3656
3/16	4.7625
13/64	5.1594
7/32	5.5563
15/64	5.9531
1/4	6.3500
17/64	6.7469
9/32	7.1438
19/64	7.5406
5/16	7.9375
21/64	8.3344
11/32	8.7313
23/64	9.1281
3/8	9.5250
25/64	9.9219
13/32	10.3188
27/64	10.7156
7/16	11.1125
29/64	11.5094
15/32	11.9063
31/64	12.3031
1/2	12.7000
33/64	13.0969
17/32	13.4938
35/64	13.8906
9/16	14.2875
37/64	14.6844
19/32	15.0813
39/64	15.4781
5/8	15.8750
41/64	16.2719
21/32	16.6688
43/64	17.0656
11/16	17.4625
45/64	17.8594
23/32	18.2563
47/64	18.6531
3/4	19.0500
49/64	19.4469

IMPERIAL	METRIC
inch	mm
25/32	19.8438
51/64	20.2406
13/16	20.6375
53/64	21.0344
27/32	21.4313
55/64	21.8281
7/8	22.2250

6.4 Troubleshooting

6.4.1 Operational Faults

Proceed as follows if you have any problems:

1. First assess the possible cause of the problem using the following table.
2. Check the remote status display. Evaluate the flash error code.
3. Carry out the necessary checks and repairs as recommended in the following table.

The various power modules can be fitted in connection with different remotes in the mobility device. Rectification of operational faults depends on the power module fitted. The power modules used are described in the corresponding controls manual.

 The tables for rectification of operational faults listed in the following chapters are only an excerpt from the original manufacturer's manuals. You can obtain the original manuals from Invacare.

6.4.2 Drive Fault Diagnosis

Problem	Other Symptoms	Possible Cause	Solution	Documentation
Mobility device will not start	The remote status display illuminates normally and shows an error code.	Drive motors disengaged	Engage drive motors.	See user manual.
	Remote status display does not illuminate	Batteries defective	Replace batteries.	See 6.12.5 <i>Replacing Batteries</i> , page 43.
		Completely discharged battery	Pre-charge batteries.	See user manual.
		Power supply to remote interrupted	Check cabling.	See 6.11.6 <i>Checking Cables</i> , page 39.
	Remote defective	Replace remote.	See LiNX service manual.	
Remote status display flashing	Various causes	Assess error code.	See remote manual.	
Mobility device judders in drive mode	None	Batteries defective (unstable voltage)	Replace batteries.	See 6.12.5 <i>Replacing Batteries</i> , page 43.
		Drive motor(s) defective	Replace motor(s).	See 6.8.1 <i>Replacing Motor</i> , page 26.
Mobility device pulls to left or right	None	Drive motors running asymmetrically	Change programming to synchronise motors.	See LiNX service manual.
	Tyre visibly dented	Not enough tyre pressure	Check tyre pressure, replace inner tube and/or valve if necessary.	

Problem	Other Symptoms	Possible Cause	Solution	Documentation
Error message does not disappear	None	Bad connections	Check cabling.	See 6.11.6 <i>Checking Cables</i> , page 39.
		Motor brake defective	Measure internal resistance of brakes, replace motor if defective.	See 5.2 <i>Testing Motor Brake</i> , page 15 and 6.8.1 <i>Replacing Motor</i> , page 26.
Motors stop and start again	None	Voltage decline	Stop driving and allow electronics to cool down.	
Motor runs but loses power	None	High motor load allows power module to lower voltage	Stop driving and allow electronics to cool down.	
Motors stop and do not start again	None	High motor load allows power module to lower voltage	Leave mobility device switched on and let power module operate. Charge batteries overnight with electronics turned on.	
		Motor defective	Measure internal resistance of motor, replace motor if defective.	See 5.1 <i>Testing Motor</i> , page 15 and 6.8.1 <i>Replacing Motor</i> , page 26.
		Power module defective	Replace power module.	See 6.11.1 <i>Replacing Power Module</i> , page 37.
Motors lose power while driving	None	Bad connections	Turn off electronics, wait 10 seconds, turn on electronics. Check cabling.	See 6.11.6 <i>Checking Cables</i> , page 39.
Motor judders or runs irregularly, or only one motor runs	None	Bearing defective	Replace motor.	See 6.8.1 <i>Replacing Motor</i> , page 26.
		Collector defective	Measure internal resistance of motor, replace motor if defective.	See 5.1 <i>Testing Motor</i> , page 15 and 6.8.1 <i>Replacing Motor</i> , page 26.
Motors do not run	None	Bad connections	Check cabling.	See 6.11.6 <i>Checking Cables</i> , page 39.
		Batteries defective	Replace batteries.	See 6.12.5 <i>Replacing Batteries</i> , page 43.
		Cabling to power module or remote defective	Check cabling.	See 6.11.6 <i>Checking Cables</i> , page 39.
		Power module defective	Replace power module.	See 6.11.1 <i>Replacing Power Module</i> , page 37.
	Corroded contacts	Contacts defective	Check cabling.	See 6.11.6 <i>Checking Cables</i> , page 39.
Motor makes clicking noise	None	Bearing defective	Replace motor.	See 6.8.1 <i>Replacing Motor</i> , page 26.
		Collector defective	Measure internal resistance of motor, replace motor if defective.	See 5.1 <i>Testing Motor</i> , page 15 and 6.8.1 <i>Replacing Motor</i> , page 26.

Problem	Other Symptoms	Possible Cause	Solution	Documentation
Scraping noise or motor blocked	None	Bearing defective	Replace motor.	See 6.8.1 Replacing Motor, page 26.
		Gearbox defective	Replace motor.	See 6.8.1 Replacing Motor, page 26.
Gearbox makes clicking noise	None	Gearbox defective	Replace motor.	See 6.8.1 Replacing Motor, page 26.
		Drive wheel loose	Tighten drive wheel, secure bolts with thread locking adhesive if necessary.	See 6.9.6 Replacing Drive Wheel (1-Bolt Installation), page 32.
Irregular running	None	Drive shaft movable or bent	Check drive shaft, replace motor, if defective.	See 6.8.1 Replacing Motor, page 26.
Batteries not being charged	None	Batteries defective	Replace batteries.	See 6.12.5 Replacing Batteries, page 43.
	LEDs flashing on charger	Charger defective	Replace charger.	See charger user manual.
Short charging period	None	One of the batteries could be defective	Replace batteries.	See 6.12.5 Replacing Batteries, page 43.
Mobility device runs too slowly	None	Remote defective	Replace remote.	See LiNX service manual.
		Batteries defective	Replace batteries.	See 6.12.5 Replacing Batteries, page 43.

6.4.3 Charging device fault diagnosis

Symptom	Possible cause	Solution
No LEDs illuminating on battery charger	Charging device not connected to mains supply.	Ensure that the battery charger has been plugged in.
	No mains supply	Check the mains supply with a voltmeter.
	Defective mains supply cable.	Check the mains supply cable. Replace damaged cables or send the battery charger to Invacare Service for repair.
	LEDs are burnt out	Send the battery charger to Invacare Service for repair.
	An internal fuse might be burnt out.	Send the battery charger to Invacare Service for repair.
Batteries do not charge	Fuse on mobility device has burnt out.	Check mobility device fuses. See “Main fuse”.
	Battery charger not connected to mobility device.	Ensure that the battery charger has been connected to the mobility device.
	No mains supply	Check the mains supply with a voltmeter.
	Defective mains supply cable.	Check the mains supply cable. Replace damaged cables or send the battery charger to Invacare Service for repair.
	Battery charger could be defective.	Use a battery charger which you know is working properly to charge the batteries. Send the defective battery charger to Invacare Service for repair.
	Battery voltage is too low to operate mobility device.	Replace the batteries. See “Removing batteries”

6.5 Service Plan (Once a Year)



CAUTION!

Risk of injury and damage to property, if maximum speed reduction on wheelchair with lifter does not function correctly

The wheelchair's electronics must reduce the maximum possible speed as soon as the lifter is raised.

– Test the maximum speed reduction for correct function after any maintenance work or modifications to the wheelchair.

Component	Check	Remedy	Notes	✓
Posture belt	Damage to posture belt	Replace belt if damaged.	See <i>Replacing Posture Belt</i> in service manual of seating system.	
	Belt lock function	Replace belt if damaged.	See <i>Replacing Posture Belt</i> in service manual of seating system.	
Armrests	Damage to armrests	Replace cover if damaged.		
	Armrest fixings	Tighten screws.		
Clothing guard	Damage to clothing guard	Replace clothing guard, if damaged.		
	Clothing guard fixings	Tighten screws.		
Powered recline (if fitted)	Damage to backrest	Replace parts if damaged.		
	Seams	Tighten screws.		
	Fixing	Replace cable or actuator if necessary.		
	Check cable			
Frames (chassis) / battery mounting	Check function			
	Check fixings, welded seams and battery mounting	Tighten screws. Replace components if necessary.		
Wheel suspension and wheels	Check drive wheels for tight fit and side play	Adjust, replace wheel hubs.	See <i>6.9.6 Replacing Drive Wheel (1-Bolt Installation)</i> , page 32.	
	Check castors for tight fit, float and side play	Replace wheels, castor forks or wheel bearings.	See <i>6.9 Wheels</i> , page 29.	
	Tyres	Repair or replace if damaged.	See <i>6.9 Wheels</i> , page 29.	
	Check suspension	Repair or replace if damaged.	See <i>6.9 Wheels</i> , page 29.	
	Check straight running	Replace wheels, castor forks or wheel bearings.	See <i>6.9 Wheels</i> , page 29.	
Drive units, clutch mechanism	Motors	Test motors.	See <i>5.1 Testing Motor</i> , page 15.	
	Check functions in drive and push modes	Replace motor if necessary. Tighten screws/nuts, adjust or replace if necessary.	See <i>6.8 Drive Components</i> , page 26.	
Brakes	Check motor brake	Test motor brake.	See <i>5.1 Testing Motor</i> , page 15.	
Legrests	Check welded seams, interlocking, screws, foot plates	Tighten, replace if necessary.		

Component	Check	Remedy	Notes	✓
Power legrests (if fitted)	Check cable Check contacts Check functions	Replace cable if necessary.		
Battery mounting	Check battery support and mounting belts for damage	Replace if necessary.		
Batteries	Check batteries for damage	Replace batteries if necessary.	See 6.12.5 Replacing Batteries, page 43 and 6.12.2 Handling Damaged Batteries Correctly, page 40.	
	Check battery voltage	Charge batteries.	See user manual.	
	Check contacts and terminals	Clean contacts and terminals.	See 6.12 Batteries, page 40.	
Remote / power module	Remote, status LED flashing	Evaluate error/flash code.	See 6.4 Troubleshooting, page 20.	
	Fixings	Tighten fixings, replace if necessary.		
	Cables and connecting plugs	Replace damaged cables and tighten connecting plugs, if necessary.		
	Joystick function	Replace joystick knob if necessary.		
		Replace remote if necessary.		
Power supply	Replace damaged cables and tighten connecting plugs, if necessary.			
Chair configuration	Check chair configuration version	Update software if newer version available.	See LiNX service manual.	
Screws (every 6 months)	Check screws for tight fit	Tighten screws if necessary.		

6.6 Overview

Under Rear Shroud/Seat

Depending on seat variant

- (1) Power module
- (2) Actuator module (optional)



Fig. 6-1

Under Seat

Depending on seat variant

- (1) Tilt actuator (optional)
- (2) Elevate actuator (optional)

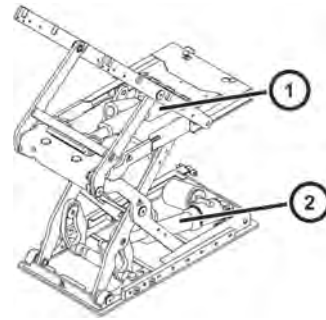

Fig. 6-2

6.7 Moving Seat into Service Position (Modulite)

It is necessary to move the seat into the service position or to remove it for maintenance purposes or if the batteries have to be removed.



CAUTION!
Risk of crushing

The seat is very heavy. Risk of injury to hands and feet.
– Use proper lifting techniques.

Risk of injury due to uncontrolled movement of the wheelchair

- Switch the vehicle's power system off (ON/OFF key).
- Engage the drive motors
- Secure the vehicle against rolling away by pressing the parking brake down.



CAUTION!
Risk of crushing

The seat has no stopper to prevent it from falling over backwards when being unlocked.
– Be careful when unlocking the seat.
– Pay attention to your hands and feet.



- Wooden block (30 x 40 x 29 cm)

1. Pull bungee cord (1) under seat on centre column (2) to unlock seat.

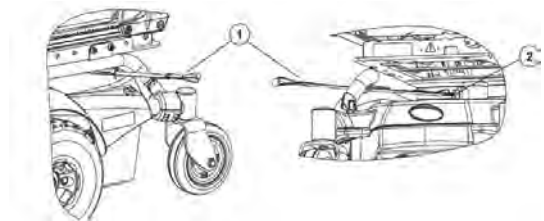

Fig. 6-3

2. Place wooden block under backrest to avoid collision of tie down bracket with seat plate in service position.
3. Carefully fold seat backwards.
4. The seat is now in service position.

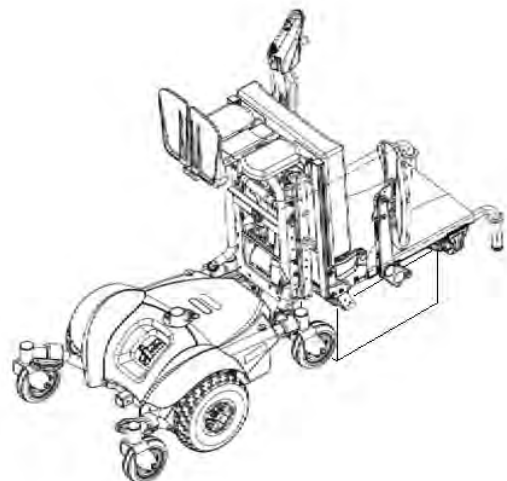

Fig. 6-4

6.8 Drive Components

6.8.1 Replacing Motor



- 24 mm wrench
- 19 mm socket wrench
- 13 mm socket wrench
- 11 mm socket wrench
- Two 5-inch (12 cm) blocks

1. Remove seat, refer to 7.1 *Replacing Seat Assembly*, page 45.
2. Remove front shroud, refer to 6.10.2 *Replacing Front Shroud*, page 36.
3. Remove batteries, refer to 6.12.5 *Replacing Batteries*, page 43.
4. Place blocks under battery frame to lift frame off the ground for ease in performing this procedure. Use proper lifting techniques.
5. Remove drive wheel, refer to 6.9.6 *Replacing Drive Wheel (1-Bolt Installation)*, page 32.
6. Cut all tie-wraps securing motor lead to frame (not shown).
7. Remove rear shroud, refer to 6.10.3 *Replacing Rear Shroud*, page 37.
8. Disconnect motor lead connectors from power module.
9. Unhook spring from frame and bracket, refer to 6.8.3 *Replacing Spring*, page 27.
10. Remove locknut (2) and spacer (3) that secure swingarm (4) assembly to frame (9).
11. Remove swingarm (4) and motor (5).
12. Remove four screws (1) that secure swingarm (4) assembly to motor (5).
13. Separate motor from swingarm.
14. Position new motor against swingarm assembly.
15. Install the four screws (4) that secure motor to swingarm assembly.
16. Install locknut (2) and spacer (3) that secure swingarm assembly to frame.
17. If necessary, repeat steps for motor on the other side.

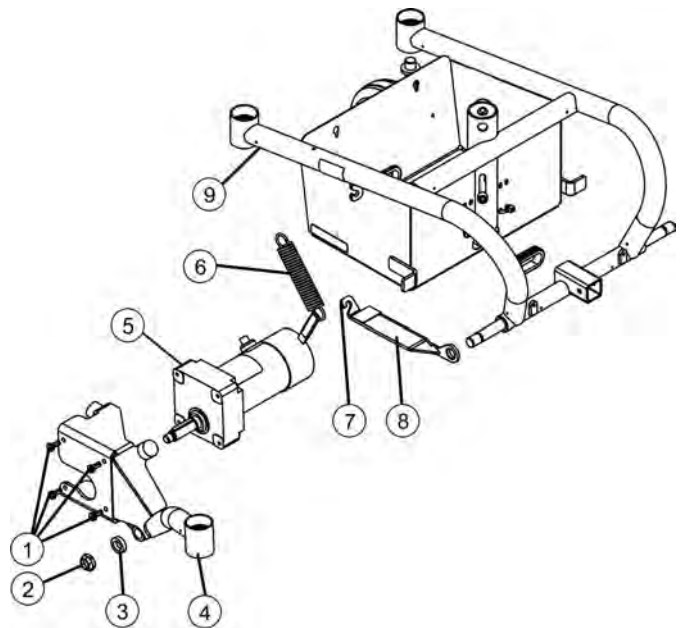

Fig. 6-5

18. Reverse first nine steps to reassemble base.
19. Test all functions.

6.8.2 Replacing Swingarm Assembly



- 24 mm wrench
- 19 mm socket wrench
- 13 mm socket wrench
- 11 mm socket wrench

1. Remove front castor assembly, refer to 6.8.4 Replacing Forks and/or Castor Assemblies, page 27.
2. Remove drive wheel, refer to 6.9.6 Replacing Drive Wheel (1-Bolt Installation), page 32.
3. Remove top shroud, refer to 6.10.1 Replacing Top Shroud, page 36.
4. Remove front shroud, refer to 6.10.2 Replacing Front Shroud, page 36.
5. Remove four screws (1) that secure swingarm (4) assembly to motor.
6. Remove locknut (2) and spacer (3) that secure swingarm (4) assembly and bracket (8) to frame (9).

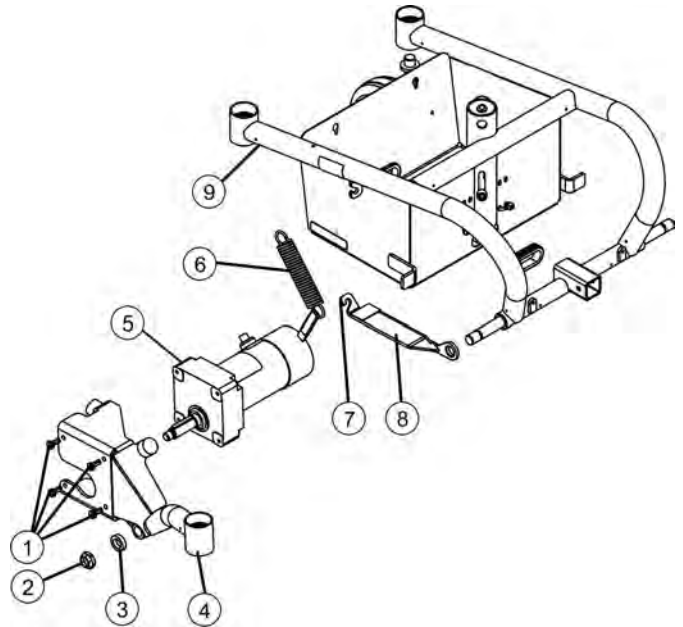

Fig. 6-6

7. Install parts in reverse order.
8. Test all functions.

6.8.3 Replacing Spring

1. Unhook spring (1) from hooks (2) on frame (3) and bracket (4).
2. Install spring (1) to hooks (2) on frame (3) and bracket (4).
3. Test all functions.

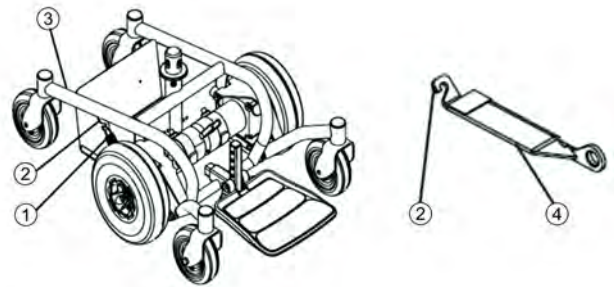

Fig. 6-7

6.8.4 Replacing Forks and/or Castor Assemblies



Front and rear forks are replaced in the same manner.



- Ratchet with 15/16 inch socket

Removing Forks and/or Castor Assemblies

1. Remove castor (7) from fork if necessary, refer to 6.9.7 *Replacing Castor Wheel on Double-Sided Fork, page 33.*
2. Remove head tube cap (1).
3. Remove locknut (2), washer (3), and spacer (5) securing the fork (6) to headtube (4).

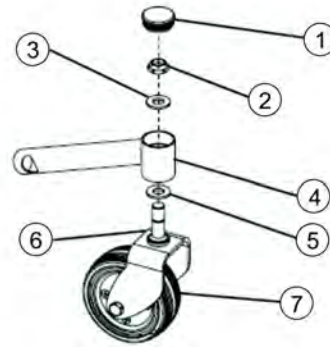



Fig. 6-8

Installing Forks and/or Castor Assemblies

1. Insert spacer (5) and threaded post of fork (6) into headtube (4).
 -  Check bearing assemblies. Replace if necessary.
2. Slide fork (6) completely into headtube (4).
3. Secure fork (6) to headtube (4) with locknut (2) and washer (3). Securely tighten.
 -  Improper positioning of washer will prohibit the free movement of the forks. Check correct position of washer.
4. Install castor (7) onto fork if removed, refer to 6.9.7 *Replacing Castor Wheel on Double-Sided Fork, page 33.*
5. Replace headtube cap (1).

6.8.5 Adjusting Forks



Tools:

- Ratchet with 15/16 inch socket

1. Remove headtube cap (1).
2. To properly tighten castor assembly (7) and guard against flutter, perform following check:
 -  Two people are recommended to perform steps 3 to 6 - one person to tip wheelchair back and one person to inspect/adjust castor assembly.
3. Tip back wheelchair.
4. Pivot both castor assemblies (7) to top of their arc simultaneously.
5. Let castors drop to bottom of arc (castors should swing once to one side, then IMMEDIATELY rest in straight downward position).
6. Adjust locknut (2) so that castor assemblies are not too loose but can still rotate freely.
7. Test wheelchair for maneuverability.
8. Readjust locknut (2) if necessary, and repeat steps 3 to 6 until correct. Test wheelchair for maneuverability.
9. Replace headtube cap (1).

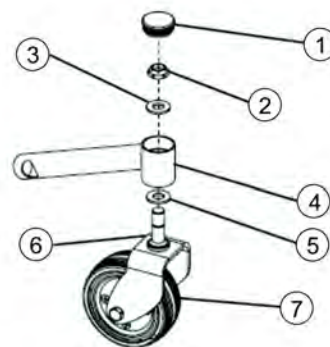

Fig. 6-9

6.9 Wheels

6.9.1 Repair Instructions



Important information about maintenance work tools!

- Some maintenance work which is described in this manual and can be carried out by the user without problems require the correct tools for proper work. If you do not have the correct tool available we do not recommend that you try to carry out the relevant work. In this case, we urgently recommend that you contact an authorised specialist workshop.

The following are instructions on maintenance and repairs that can be performed by the user. For the specifications of spare parts please see *Technical Data*, or consult the service manual, available from Invacare (in this connection please see the addresses and phone numbers at the end of this user manual). In case you require assistance, please contact your Invacare dealer.



CAUTION!

Risk of damage or injury if the mobility device is accidentally set into motion during repairs

- Switch the power off (ON/OFF Button).
- Engage the motors.
- Secure the mobility device against rolling away by placing wedges under the wheels.



CAUTION!

Risk of hands and feet being crushed by the weight of the wheelchair

- Pay attention to your hands and feet.
- Use the correct lifting techniques.

6.9.2 Tyre Pressure



CAUTION!

Risk of damage to rim and tyre when tyre pressure is exceeded

- Observe recommended tyre pressure.

For recommended tyre pressure see inscription on tyre, rim, or contact Invacare. Compare table below for conversion.

psi	bar
22	1.5
23	1.6
25	1.7
26	1.8
28	1.9
29	2.0
30	2.1
32	2.2
33	2.3
35	2.4
36	2.5
38	2.6
39	2.7
41	2.8
42	2.9
44	3.0

6.9.3 Tyre Types

There are three different types of tyres or inner tubes, and specific points must be observed for the replacement of each type. The individual types of tyres can be easily distinguished:

- Pneumatic tyres have black valve caps.
- Puncture-protected tyres have red valve caps.
- Puncture-proof tyres have no valves.









There are five chapters about tyre repair and wheel replacement:









- *Replacing Drive Wheel (5-Screw Installation)*
- *6.9.6 Replacing Drive Wheel (1-Bolt Installation), page 32*
- *6.9.7 Replacing Castor Wheel on Double-Sided Fork, page 33*
- *Replacing Castor Wheels on Single-Sided Fork*
- *Replacing Tyres* deals with tube repair and replacing solid tyres.

 Not all chapters are necessarily contained in this manual.

 Specific tightening torques for wheels and rim halves are listed in *6.9.4 Specific Tightening Torques, page 30*.

6.9.4 Specific Tightening Torques















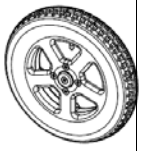





















	Drive Wheels							
	10" x 3"		12 1/2" x 2 1/4"			14"		
								
Wheel Fixation	70 Nm	70 Nm	33 Nm	35 Nm	70 Nm	33 Nm	60 Nm	25 Nm
Rim Halves	25 Nm	25 Nm	10 Nm	25 Nm	25 Nm	10 Nm	25 Nm	25 Nm

	Castor Wheels							
	6"		8"			9"		10"
								
Wheel Fixation	18 Nm	18 Nm	16 Nm	16 Nm	25 Nm	25 Nm	18 Nm	100 Nm
Rim Halves	10 Nm	25 Nm	—	—	—	25 Nm	25 Nm	25 Nm

















6.9.5 Overview of Power Wheelchair Models and Wheel Types

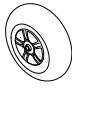































- Not all wheel types are available for all power wheelchairs, see footnotes.
- The symbols indicate three tyre types:

		
pneumatic = black valve cap	puncture-protected = red valve cap	puncture-proof = no valve

Models	Drive wheels							
	10" x 3"	12 1/2" x 2 1/4"			14"			
								
4-Spoke Rim (1-Bolt Installation)	3-Spoke Rim (1-Bolt Installation)	5-Spoke Rim (1-Bolt Installation)	5-Spoke Plastic Rim (1-Bolt Installation)	3-Spoke Rim (1-Bolt Installation)	5-Spoke Rim (1-Bolt Installation)*	5-Spoke Rim (5-Screw Installation)	5-Spoke Rim for True Track*	
TDX SP2							  	
Storm ⁴ Series							  	  
Kite					  		  	
Bora		 	 					
Fox		 						
Stream								
Mirage			 					
Dragon			 					
Pronto M41								

* For wheelchair-specific mounting instruction, see respective manual.

Models	Castor Wheels								
	6"	8"				9"	10"		
						 	 		
Single-Sided/ Double-Sided Fork	Double-Sided Fork				Double-Sided Fork	Double-Sided Fork	Single-Sided Fork		
TDX SP2									
S4 Series							  	  	

Models	Castor Wheels								
	6"		8"			9"	10"		
						 	 		
Single-Sided/ Double-Sided Fork	Double-Sided Fork				Double-Sided Fork	Double-Sided Fork	Single-Sided Fork		
Kite						* *  	  	  	
Bora				 		 			
Fox									
Stream									
Mirage			 						
Dragon									
Pronto M41									

* For wheelchair-specific mounting instruction, see respective manual.

6.9.6 Replacing Drive Wheel (1-Bolt Installation)

This chapter deals with drive wheels that are installed with one central bolt.



CAUTION!
Risk of Crushing to Hands and Feet by Weight of Mobility Device

- Pay attention to hand and feet.
- Use proper lifting techniques.



CAUTION!
Risk of Uncontrolled Movement of Mobility Device

- Turn off power supply (ON/OFF key).
- Engage drive.
- Before raising mobility device, secure wheels by blocking them with wedges.
- Prevent the mobility device tipping by propping it up on a wooden block which is long and wide enough under the battery case. If the wooden block is too short or too high, the mobility device can still tip.



- 19 mm wrench
- Flat screwdriver
- Tightening kit
- Oblong wooden blocks (at least 14 x 14 x 30 cm)

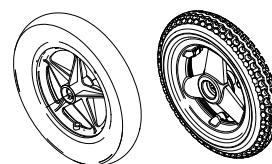

Removing Wheel

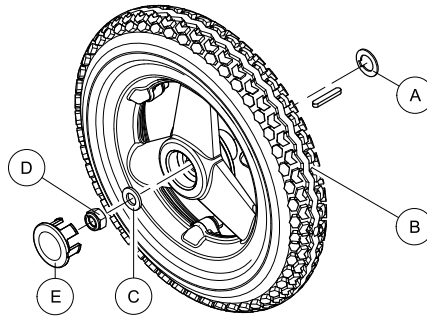

Fig. 6-10

1. Remove plastic cap ⑤.
2. Loosen and remove nut ④ and washer ③.
3. Remove wheel ② from axle.
4. Remove remaining washer ①.

Installing Wheel

1. Install parts in reverse order.
2. When installing wheel, pay attention to correct direction of rotation.
3. Tighten nut to prescribed torque. See 6.9.4 *Specific Tightening Torques*, page 30.

Replacing Wheel (10" x 3")



- 19 mm wrench
- Oblong wooden blocks (at least 14 x 14 x 30 cm)

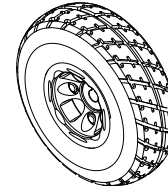

Removing Wheel

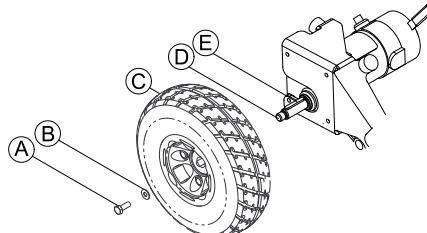

Fig. 6-11

1. Loosen and remove nut ① and washer ②.
2. Remove wheel ③ from drive shaft ④. If necessary, use wheel puller to remove wheel from drive shaft.

Installing Wheel

1. Apply anti-seize compound to drive shaft ④ and keystone ⑤.

! Do not apply more than one-inch (25.4 mm) (in length) thin film of anti-seize compound to the drive shaft. Applying more than one-inch (25.4 mm) (in length) can cause the anti-seize compound to leak resulting in damage to flooring (carpet, tile, etc.).

2. When installing wheel, pay attention to correct direction of rotation.
3. Align keystone in drive shaft with cutout in wheel hub and position wheel on drive shaft.



Ensure keystone in cutout on drive shaft. Keystone must line up with wheel hub cutout.

4. Tighten nut to prescribed torque. See 6.9.4 *Specific Tightening Torques*, page 30.

6.9.7 Replacing Castor Wheel on Double-Sided Fork



- 5 mm Allen key
- 13 mm wrench
- Oblong wooden block (at least 14 x 14 x 30 cm)





- 13 mm wrench (2x)
- Oblong wooden block (at least 14 x 14 x 30 cm)



- 6 mm Allen key
- 13 mm wrench
- Oblong wooden block (at least 14 x 14 x 30 cm)



- 6 mm Allen key
- 13 mm wrench
- Oblong wooden block (at least 14 x 14 x 30 cm)



- 5 mm Allen key
- Oblong wooden block (at least 14 x 14 x 30 cm)



- 5 mm Allen key
- 13 mm wrench
- Oblong wooden block (at least 14 x 14 x 30 cm)



Removing Wheel

1. Place wooden block underneath mobility device and prop up mobility device.
2. Remove end-caps from bolt and nut (if applicable).
- 3.

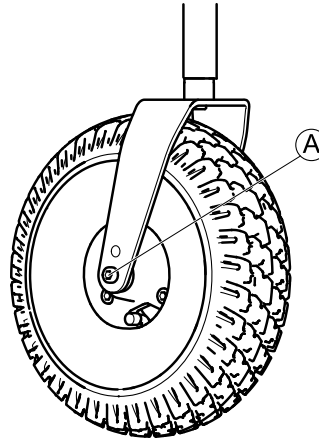

Fig. 6-12

Remove nut from bolt (A).

4. Remove bolt and wheel from fork.

Installing Wheel

1. Install parts in reverse order.
2. When installing wheel, pay attention to correct direction of rotation.
3. Tighten nut to prescribed torque. See 6.9.4 *Specific Tightening Torques*, page 30.

Replacing Castor Wheel (Aviva RX and Storm⁴ Max)



- 5 mm Allen key (up to August 2016)
- TX40 Torx key (starting August 2016)
- Oblong wooden block (at least 14 x 14 x 30 cm)

Removing Wheel

1. Loosen and remove bolts (A).
- 2.

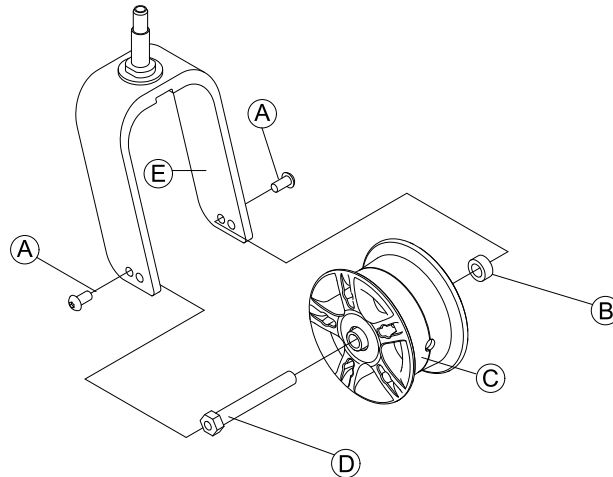

Fig. 6-13

Pull wheel (C) including axle (D) and bushing (B) out of fork (E).

Installing Wheel



CAUTION!

Risk of injury from wheels coming loose

If wheels are insufficiently secured during mounting, it can come loose when driving.

- When mounting wheels tighten bolts with prescribed torque.
- Secure all bolts using a suitable blocker.
- Never use normal nuts instead of self-locking nuts.
- Always use new nuts and bolts with an undamaged coating.

1. Install parts in reverse order. Pay attention to correct direction of rotation when installing wheels.
2. Test all functions.

Replacing Castor Wheel (6 inch wheel)



- 2 x 7/16 inch wrench
- Oblong wooden block (at least 14 x 14 x 30 cm)



Removing Wheel

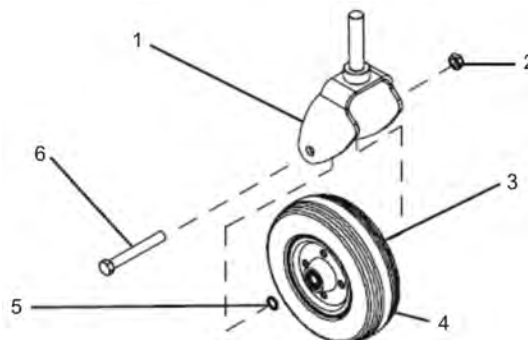

Fig. 6-14

1. Loosen nut (2).
2. Remove screw (6).
3. Remove two washers (3) and (5).
4. Remove wheel (4).
5. Replace any defective parts.

Installing Wheel

1. Install parts in reverse order.
2. When installing wheel, pay attention to correct direction of rotation.
3. Tighten nut to prescribed torque. See 6.9.4 *Specific Tightening Torques*, page 30.

6.10 Shrouds

6.10.1 Replacing Top Shroud

-  • Slotted screwdriver
-  • Phillips screwdriver

Removing Top Shroud

- 1.
2. Disconnect joystick.
3. Remove seat assembly, refer to *7.1 Replacing Seat Assembly, page 45*.
4. Remove two screws (2) that secure top shroud (5) to frame (3).
5. Remove two screws (2) that secure both top shroud (5) and front shroud (1) to frame (3).
6. Remove top shroud (5) by pulling top shroud forward then up to clear motor release levers and seat post.

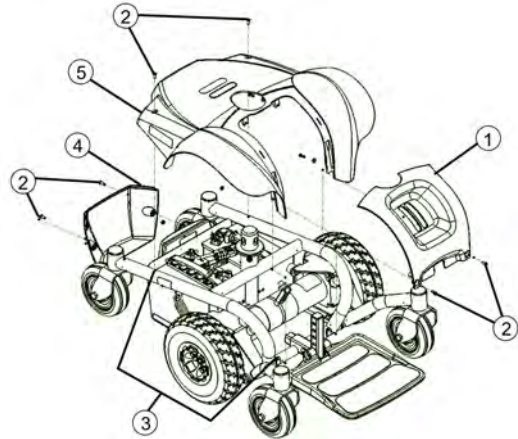



Fig. 6-15

Installing Top Shroud

1. Pull joystick cable through center hole in top shroud (5).
2. Place top shroud (5) on base frame.
 -  Pull cover forward to clear motor release levers.
3. Install two screws (2) that secure top shroud (5) to frame (3). Do not overtighten.
4. Attach front shrouds (1) to top shroud (5).
5. Install two screws (2) that secure both top shroud (5) and front shroud (1) to frame (3). Do not overtighten.
6. Install seat assembly. See *7.1 Replacing Seat Assembly, page 45*.
7. Connect joystick.

6.10.2 Replacing Front Shroud

-  • Slotted screwdriver
-  • Phillips screwdriver

Removing Front Shroud

1. Remove two screws (2) that secure both top shroud (5) and front shroud (1) to frame (3).
2. Remove front shroud (1) from frame (3).

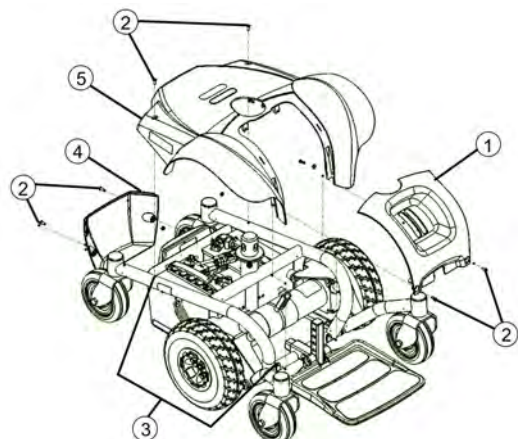

Fig. 6-16

Installing Front Shroud

1. Insert tabs at bottom of front shroud (1) into slots in bottom of frame (3).
2. Secure bottom of front shroud (1) to frame using two screws (2). Do not overtighten.

6.10.3 Replacing Rear Shroud



- Slotted screwdriver
- Phillips screwdriver

Removing Rear Shroud

1. Remove two screws (2) that secure rear shroud (4) to frame (3).
2. Remove rear shroud (4).

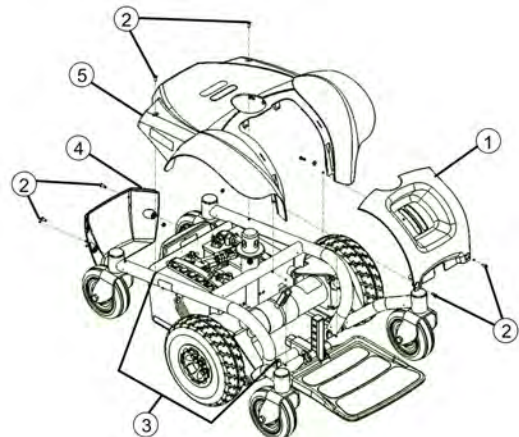

Fig. 6-17

Installing Rear Shroud

1. Insert tabs at bottom of rear shroud (4) into slots in bottom of frame (3).
2. Secure rear shroud (2) to frame (3) using two screws (2). Do not overtighten.

6.11 Controls

6.11.1 Replacing Power Module

When replacing the power module or remote, take into account the final selection of the drive program, refer to [6.11.4 Drive Program Selection After Component Replacement](#), page 39.

Different combinations of power modules and remotes can be fitted to the mobility device. Power modules are described in earlier revisions of this service manual or in the LiNX service manual.



CAUTION!

Any changes to drive program can affect driving characteristics and tipping stability of mobility device.

- Changes to drive program may only be carried out by qualified technicians.
- Invacare can only give a warranty for safe mobility device driving behaviour – especially tipping stability – for unaltered standard drive programs.



All power modules are delivered with a standard drive program. If you have made any customer-specific modifications to the drive program, these must be adapted after the installation of the new power module.



- 8 mm socket wrench
- To adapt the drive program: programming software and LiNX service manual, available from Invacare.

Removing Power Module

1. Turn off electronics on remote.
2. Remove seat, refer to *7.1 Replacing Seat Assembly, page 45* or move seat into service position, refer to *6.7 Moving Seat into Service Position (Modulite), page 25*.
3. Remove top shroud, refer to *6.10.1 Replacing Top Shroud, page 36*.
4. Remove rear shroud, refer to *6.10.3 Replacing Rear Shroud, page 37*.
5. Take exact note of positions of all cables and the sockets that they are connected to. Mark the connectors and sockets or take a photograph with a digital camera.
6. Remove plugs **(A)** from power module.
7. Loosen and remove screws **(B)**.
8. Remove power module.

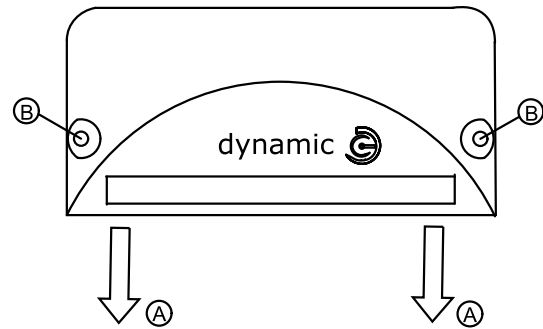



Fig. 6-18

Installing Power Module

1. Replace power module.
2. Install parts in reverse order.
 -  For details on cable routing, refer to LiNX service manual.
3. Update drive program if new software version is available, refer to *Updating Software*.
Select driving program, refer to *6.11.4 Drive Program Selection After Component Replacement, page 39*.
4. Plug all free slots with suitable covering cap.
5. Adapt drive program using programming software if necessary.
6. If LiNX system is used, perform calibration process, refer to *Suggested programing procedure* in LiNX service manual.
7. Test all functions.

6.11.2 Checking Actuator



1. Switch electronics OFF on remote.
2. Move seat into service position (Modulite seat), refer to *6.7 Moving Seat into Service Position (Modulite), page 25*.
3. Take exact note of positions of all cables and sockets that they are connected to. Mark connectors and sockets or take photograph.
4. Disconnect motor plug of motor to be tested from actuator module.
5. Check electrical resistance at plug of actuator.
6. If resistance is close to infinity, motor is probably burnt out.
7. If resistance is below 1, motor has short-circuit.
8. Motor must be replaced in both cases.

6.11.3 Updating Software

See LiNX service manual.

6.11.4 Drive Program Selection After Component Replacement

The drive program is saved in the remote, and also in the power module. If one of these two components is replaced, the system must be told which of the components has not been replaced so that it knows which contains the current controller profile.

-  The system allows normal usage of the mobility device after component replacement only if the profile is selected afterwards.
-  For details, see corresponding remote manual.

6.11.5 Cable Routing



WARNING!

Cables must be secured to the wheelchair frame and/or base with tie-wraps after servicing is complete. Failure to follow the warnings and instructions below could result in injury to the users, attendants and/or bystanders and/or damage to the wheelchair.

- Cables **MUST** be secured so there are no loops of excess cable extending away from the wheelchair. Bundle all excess cable together and secure with a tie-wrap. It may also be necessary to secure these bundles to the frame and/or base.
- **ALWAYS TEST** all wheelchair functions after securing the cables to be sure cables do not get pinched or crushed during operation of the wheelchair.

-  Motors not shown for clarity. The motor cables are routed out the hole located at the back of the battery box.
- Route the joystick cable, two battery cables and the motor cable beneath the shroud tabs, see *6.10 Shrouds*, page 36.

- 1 Motor cable tie wraps
- 2 Battery cable
- 3 Motor cable
- 4 Shroud tab
- 5 Power module
- 6 Joystick cable
- 7 Battery connector
- 8 Tie wrap here
- 9 Bus extension cable

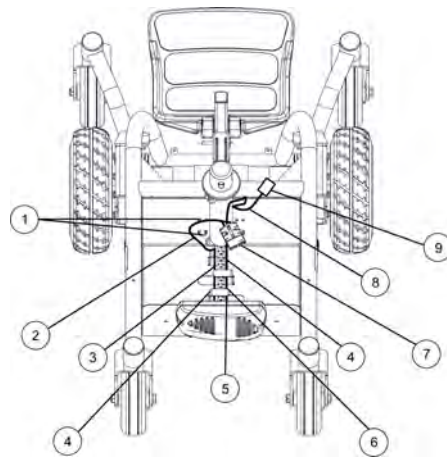

Fig. 6-19

6.11.6 Checking Cables

1. Switch electronics OFF on remote.
2. Move seat into service position (Modulite seat), refer to *6.7 Moving Seat into Service Position (Modulite)*, page 25 or remove seat, refer to *7.1 Replacing Seat Assembly*, page 45.
3. Remove top and rear shroud, refer to *6.10.1 Replacing Top Shroud*, page 36 and *6.10.3 Replacing Rear Shroud*, page 37.
4. Check all cables for visible damage, crushing points or abrasion points.
5. Replace damaged cables.
6. Pull on each plug carefully. Plug must not come out of its socket when pulled on lightly.
7. If plug is loose, apply slight pressure to push plug into socket. Plug must snap in place securely.
8. Check that plug is firmly attached to its socket.
9. Remove batteries, refer to *6.12.5 Replacing Batteries*, page 43.
10. Check battery cables for visible damage, crushing points or abrasion points.
11. Replace damaged cables.
12. Assemble all parts again in reverse order.
13. Test all functions.

6.12 Batteries



CAUTION!

Injury hazard and possible material damages if batteries are handled improperly

- The installation of new batteries may only be carried out by authorised specialists.
- Observe the warning information on the batteries.
 - Only use battery versions stated in the specifications.



CAUTION!

Fire and burns hazard if battery terminal is bypassed

- Take great care to ensure that the battery terminals are never short-circuited with tools or mechanical mobility device parts.
- Ensure that the battery terminal caps have been replaced if you are not working on the battery terminals.



CAUTION!

Risk of crushing

- Batteries can be extremely heavy. This results in injury hazards to your hands.
- Handle the batteries with care.
 - Ensure that batteries do not fall to the ground when removed from chassis.
 - Pay attention to hands.
 - Use proper lifting techniques.



WARNING!

Burn hazard

Injury hazard due to discharged acid.

- Always wear acid-proof protective gloves when handling batteries.
- Always wear protective goggles when handling batteries.

What to do if acid is discharged

- Always take clothing which has been soiled by or dipped in acid off immediately!
- Rinse any areas of your skin which has come into contact with battery acid off immediately with plenty of water!

If contact with eyes is made

- You should also consult an eye specialist immediately afterwards!



When removing, take care of small parts such as screws and washers. Put all small parts down so that they can be installed in correct sequence.

6.12.1 General Instructions on Handling Batteries

- Never mix and match different battery manufactures or technologies, or use batteries that do not have similar date codes.
- Never mix gel with AGM batteries.
- The batteries reach their end of life when the drive range is significantly smaller than usual. Contact your provider or service technician for details.
- Always have your batteries installed by a properly trained mobility device technician or a person with adequate knowledge. They have the necessary training and tools to do the job safely and correctly.

6.12.2 Handling Damaged Batteries Correctly



CAUTION!

Corrosion and burns from acid leakage if batteries are damaged

- Remove clothes that have been soiled by acid immediately.

After contact with skin:

- Immediately wash affected area with lots of water.

After contact with eyes:

- Immediately rinse eyes under running water for several minutes; consult a physician.

- Always wear safety goggles and appropriate safety clothing when handling damaged batteries.
- Place damaged batteries in an acid-resistant receptacle immediately after removing them.
- Only ever transport damaged batteries in an appropriate acid-resistant receptacle.
- Wash all objects that have come into contact with acid with lots of water.

Disposing of Dead or Damaged Batteries Correctly

Dead or damaged batteries can be given back to your provider or directly to Invacare.

6.12.3 Using Proper Batteries



WARNING!

Personal injury or damage may occur in case of wrong terminal configuration.

- Batteries with terminal configuration as shown below must be used. Batteries that have reverse terminal configuration must not be used.

1. Place battery (1) on ground/flat surface.
2. Visually draw horizontal and vertical centreline through middle of battery.
3. Position battery so that terminals are above horizontal centreline.
4. Visually inspect battery to ensure correct position of positive (2) and negative (3) terminals.

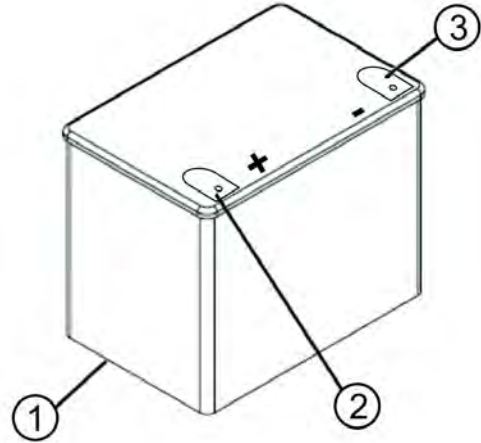

Fig. 6-20

6.12.4 Connecting/Disconnecting Battery Cables



WARNING!

Electrical hazard

Serious personal injury or damage may occur in case of an electrical short.

- NEVER allow any of your tools and/or battery cables to contact both battery terminals at the same time.
- Connect same colour connectors to each other (red to red, black to black).
- DO NOT remove the fuse or mounting hardware from the POSITIVE (+) battery cable mounting screw. To replace the fuse, obtain and replace battery harness with fuse.
- The POSITIVE (+) battery cable MUST connect to the POSITIVE (+) battery terminal; otherwise serious damage will occur to the electrical system.
- The use of rubber gloves is recommended when working with batteries.



DANGER!

Electrical hazard

Serious personal injury or damage may occur in case of wrong terminal configuration.

- DO NOT remove fuse or mounting hardware from POSITIVE (+) red battery cable/mounting screw.
- Battery terminal configuration as shown in the following figure MUST be used. Batteries that have the terminal configuration reversed MUST NOT be used - otherwise serious injury or damage may occur.
- Install protective caps on POSITIVE (+) and NEGATIVE (-) terminals.
- All battery terminal caps (two on the right battery and two on the left battery) MUST be installed prior to use.



Risk of damage to the battery cable.

- The battery cables MUST be connected to the battery terminals, as shown in following figure (depending on battery type), otherwise damage to the battery cable may result when installing battery terminal caps.

- 1 Positive (+) battery terminal of left battery
- 2 Positive (+) battery cable
- 3 Negative (-) battery cable
- 4 Negative (-) battery terminal of right battery
- 5 Positive (+) battery terminal of right battery
- 6 Positive (+) battery cable
- 7 Connector to power module
- 8 Negative (-) battery cable
- 9 Negative (-) battery terminal of left battery
- 10 Fuse

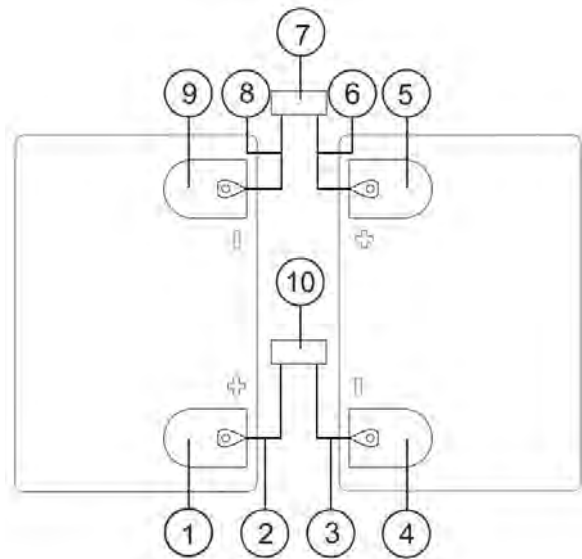

Fig. 6-21

Connecting Battery Cables



- Phillips screwdriver

1. Position batteries into wheelchair. See 6.12.5 *Replacing Batteries*, page 43.
2. Connect POSITIVE (+) battery cable (2) to POSITIVE (+) battery terminal of left battery (1).
3. Connect NEGATIVE (-) battery cable (3) to NEGATIVE (-) battery terminal of right battery (4).
4. Connect POSITIVE (+) battery cable (6) to POSITIVE (+) battery terminal of right battery (5).
5. Slide terminal caps (not shown) onto all battery terminals.
6. Plug connector (7) into power module.



New batteries MUST be fully charged before using, otherwise life of batteries will be reduced.

Disconnecting Battery Cables



DANGER!

Risk of damage and injuries

Serious personal injury or damage may occur in case of an electrical short.

- The use of rubber gloves is recommended when working with batteries.
- Never allow any of your tools and/or battery cables to contact both battery terminals at the same time.



- Phillips screwdriver

1. Disconnect connector (7) from power module.
2. Slide terminal caps (not shown) away from all battery terminals.
3. Disconnect NEGATIVE (-) battery cable (8) from NEGATIVE (-) battery terminal of left battery (9).
4. Disconnect POSITIVE (+) battery cable (2) from POSITIVE (+) battery terminal of left battery (1).
5. Remove batteries from wheelchair. See 6.12.5 *Replacing Batteries*, page 43.

Replacing Fuse



- Phillips screwdriver

1. Disconnect connector (7) from power module.
2. Slide terminal caps (not shown) away from battery terminals (1) and (4).
3. Disconnect POSITIVE (+) battery cable (2) from POSITIVE (+) battery terminal of left battery (1).
4. Disconnect NEGATIVE (-) battery cable (3) from NEGATIVE (-) battery terminal of right battery (4).
5. Replace harness with fuse (10).
6. Install parts in reverse order.

6.12.5 Replacing Batteries



CAUTION!

Risk of injury due to discharged acid

- Always use the battery handle when lifting the battery. It is the most convenient method and assures that the battery acid will not spill. It also helps to prolong the life of the battery.
- Do not tip the batteries. Keep the batteries in an upright position.



If there is battery acid in the bottom of the battery tray or on the sides of the battery, apply baking soda to these areas to neutralise the battery acid. Before reinstalling the existing or new battery, clean the baking soda from the battery tray or battery being sure to avoid contact with skin and eyes. Determine source of contamination. Never install/reinstall a battery with a cracked or otherwise damaged case.

- 1 Seat service position (Modulite only) / Standard or Captain's Seat
- 2 Shroud
- 3 Batteries
- 4 Battery tray



Fig. 6-22

- 5 Left battery
- 6 Connector to power module
- 7 Right battery
- 8 Fuse

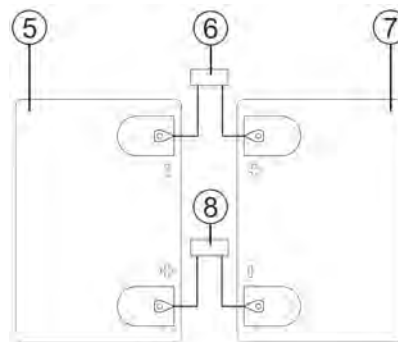

Fig. 6-23

Removing Batteries

1. Verify electronics are switched OFF and disconnect joystick cable (not shown).
2. Remove seat, refer to 7.1 *Replacing Seat Assembly, page 45*, or move Modulite seat into service position, refer to 6.7 *Moving Seat into Service Position (Modulite), page 25*.
3. Remove top shroud, refer to 6.10.1 *Replacing Top Shroud, page 36*.
4. Disconnect battery cables. See 6.12.4 *Connecting/Disconnecting Battery Cables, page 41*.
5. Lift left (5) and right (7) batteries out of battery tray (4).



With Modulite seat take care to first remove left, then right battery.

Installing Batteries

1. Verify electronics are switched OFF and disconnect joystick cable (not shown).
2. Position right battery (7) in battery tray (4).
3. Position left battery (5) in battery tray.



Ensure that both batteries are properly seated and resting on battery tray.

4. Connect battery cables. See *6.12.4 Connecting/Disconnecting Battery Cables, page 41*.
5. Reinstall top shroud.
6. Reinstall seat.
7. Connect joystick cable (not shown).

7 Seating

- This manual refers to configurations with Standard and Captain's Seat only.
- For Modulite seat system, refer to corresponding Modulite service manual.

7.1 Replacing Seat Assembly



WARNING!

After any adjustments, repair or service and before use, make sure that all attaching hardware is tightened securely - otherwise injury or damage may result.

- Before performing any maintenance, adjustment or service verify that ON/OFF switch on the joystick is in the OFF position.

Removing Seat Assembly

1. Disconnect joystick.
2. Pull release lever to fold down seat back (1).
3. Pull seat lever (5) up and lift seat assembly (2) up and away from seat post (4).

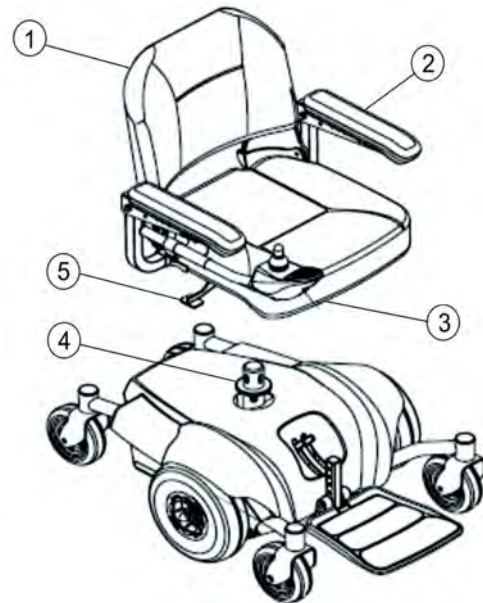



Fig. 7-1

Installing Seat Assembly

1. Align seat pivot (3) with seat post (4).
2. Pull seat lever (5) up and lower seat assembly (2) on seat post (4).
 -  If necessary, slightly twist seat assembly back and forth to lock it in place.
3. Release seat lever (5).
4. Pull seat assembly (2) up to ensure that it is locked in place.
5. Connect joystick.

7.2 Adjusting Sling Backrest (Standard Seat)

The sling backrest can be individually adapted to the user's back shape.

1. Pull front and rear faces of backrest upholstery (1) apart and remove. Backrest upholstery front and rear faces are held together using hook-and-loop fastenings.
2. Open backrest belt (2) with hook-and-loop fastenings and adjust to required length.
3. Attach upholstery and fix with hook-and-loop fastenings.

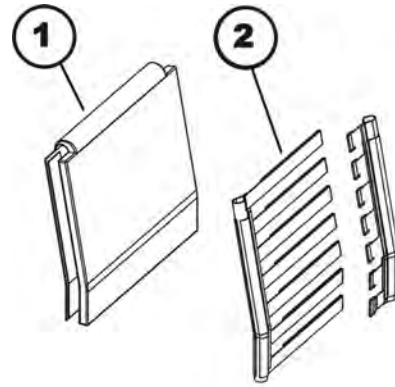

Fig. 7-2

7.3 Replacing Backrest (Standard Seat)



- 5 mm Allen key
- 10 mm wrench
- 13 mm wrench

1. Remove backrest cushion.
2. Loosen and remove handwheels (3).
3. Loosen bolts (4) including nuts and washers on the left-hand and right-hand side.
4. Remove backrest tube (1) from backrest holders (2).

If Backrest Holders also need to be replaced

5. Loosen and remove Allen screws (5) including nuts and washers on the left-hand and right-hand side.
6. Install parts in reverse order.
7. Test all functions.

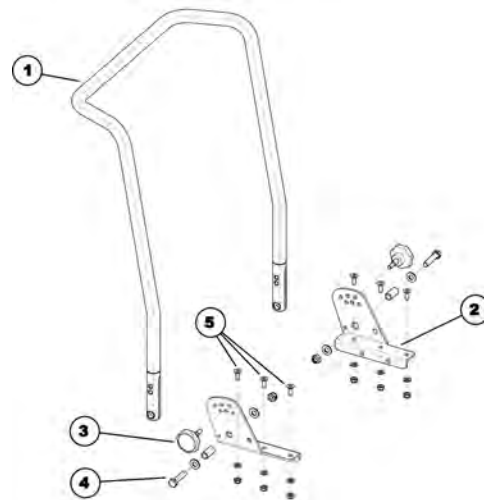

Fig. 7-3

7.4 Replacing Armrest (Captain's Seat)



- 12 mm box wrench
- 13 mm box wrench

1. If necessary, disconnect joystick.
2. Loosen lever (1) that secures armrest (3) to armrest support tube (2).
3. Remove armrest from armrest support tube.
4. If necessary, repeat first three steps to remove remaining armrest.
5. Install parts in reverse order.
6. Test all functions.

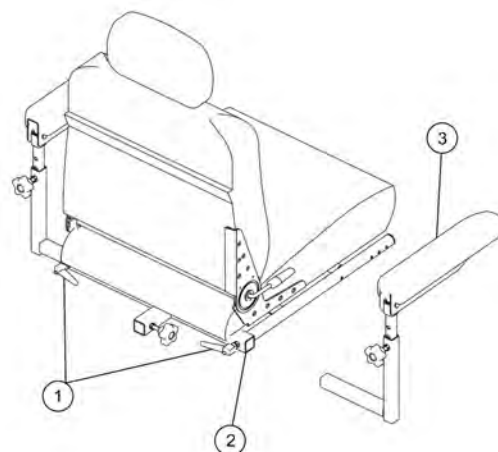

Fig. 7-4

7.5 Replacing Armrest Assembly (Captain's Seat)



- 12 mm box wrench
- 13 mm box wrench

1. If necessary, remove joystick.
2. Remove mounting screw (6), three washers (5), and locknut (4) that secures existing armrest (1) to armrest post (3).
3. Discard old/existing armrest.
4. Position new armrest on armrest post and secure with mounting screw (6), three washers (5), and locknut (4).
5. If necessary, install joystick.
6. Repeat first four steps for opposite armrest, if necessary.

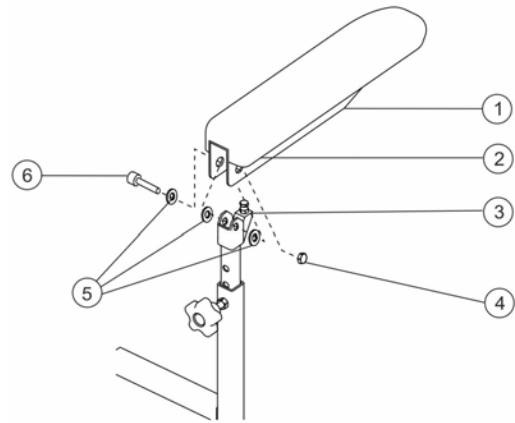

Fig. 7-5

7.6 Replacing Postural Belt (Standard Seat)



A nut is fixed between the two washers (2) and (4) as a spacer so that the belt mounting can rotate freely.



- 5 mm Allen key
- 13 mm socket wrench

1. Remove plastic cap (5).
2. Loosen bolt (3) and associated nut (covered by plastic cap).
3. Remove nut.
4. Remove bolt including postural belt and flat washers (2) and (4).
5. Remove flat washers (4).
6. Replace posture belt (1).
7. Install parts in reverse order.

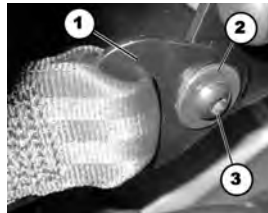

Fig. 7-6



Fig. 7-7

7.7 Replacing Postural Belt (Captain's Seat)



WARNING!

Always wear your posture belt. The posture belt is a positioning belt only. It is not designed for use as a safety device withstanding high stress loads such as auto or aircraft safety belts. If signs of wear appear, belt must be replaced immediately.



- 3/16 inch Allen key

1. Remove two mounting screws (2) that secure posture belt to seat frame.
2. Remove two halves of the posture belt (3) from rear seat frame.
3. Reposition two new posture belt (3) halves underneath seat rails.
4. Install two mounting screws (2) to secure posture belts (3) to seat frame. Securely tighten.

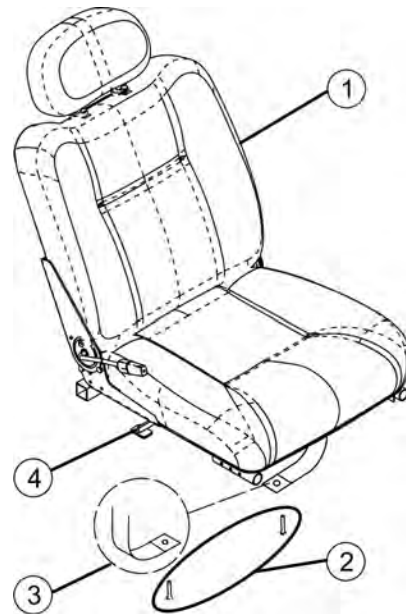

Fig. 7-8

7.8 Replacing Footboard Assembly



WARNING!
Pinch point may occur when rotating the footboard assembly.

Removing Footboard Assembly

1. Remove quick release pin (2) that secures footboard assembly (4) to wheelchair frame by depressing button while sliding pin out.
2. Remove footboard assembly (4) from wheelchair frame.

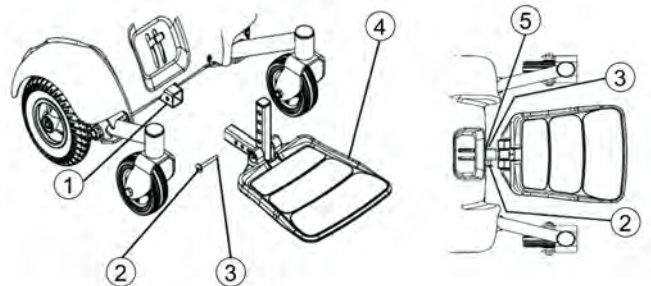

Fig. 7-9

Installing Footboard Assembly

Make sure the detent balls (3) of the quick-release pin (2) are fully released beyond the outer edge of the tube (5) before operating the wheelchair. Otherwise, injury and/or damage may result. Keep detent balls clean.



WARNING!
Make sure the detent balls (3) of the quick-release pin (2) are fully released beyond the outer edge of the tube (5) before operating the wheelchair. Otherwise, injury and/or damage may result. Keep detent balls clean.

1. Position the footboard assembly (4) onto wheelchair frame so that mounting hole (1) in wheelchair frame aligns with desired mounting hole (1) in footboard assembly (4).
2. Install quick release pin (2) by depressing button while sliding pin in. Ensure that detent balls (3) are engaged with outer edge of tube (5).

Invacare Sales Companies

Australia:

Invacare Australia Pty. Ltd.
1 Lenton Place, North Rocks NSW
2151
Australia
Phone: 1800 460 460
Fax: 1800 814 367
orders@invacare.com.au
www.invacare.com.au

United Kingdom:

Invacare Limited
Pencoed Technology Park, Pencoed
Bridgend CF35 5AQ
Tel: (44) (0) 1656 776 222
Fax: (44) (0) 1656 776 220
uk@invacare.com
www.invacare.co.uk

Canada:

Invacare Canada L.P.
570 Matheson Blvd East, Unit 8
CDN Mississauga, On. L4Z 4G4
Phone: (905) 890 8300
Toll Free: 800.668.5324
www.invacare.ca

Eastern Europe, Middle East & CIS:

Invacare EU Export
Am Achener Hof 8
D-88316 Isny
Tel: (49) (0)7562 700 397
eu-export@invacare.com
www.invacare-eu-export.com

Ireland:

Invacare Ireland Ltd,
Unit 5 Seatown Business Campus
Seatown Road, Swords, County Dublin
Tel : (353) 1 810 7084
Fax: (353) 1 810 7085
ireland@invacare.com
www.invacare.ie

New Zealand:

Invacare New Zealand Ltd
4 Westfield Place, Mt Wellington 1060
New Zealand
Phone: 0800 468 222
Fax: 0800 807 788
sales@invacare.co.nz
www.invacare.co.nz



Manufacturer:

Invacare Deutschland GmbH
Kleiststraße 49
D-32457 Porta Westfalica
Germany

