

# Seating & Positioning Price List

## Retail

### April 2020



T: 01656 776222  
F: 01656 776220  
E: [ordersUK@invacare.com](mailto:ordersUK@invacare.com)



thinkclinicalseating



[www.thinkclinicalseating.co.uk](http://www.thinkclinicalseating.co.uk)



	<b>Page</b>
<b>WCCU cushion</b>	<b>5</b>
<b>Essential cushions</b>	<b>7 - 12</b>
• Essential cushion	7
• Essential Low Profile	9
• Essential Visco	11
<b>Propad cushions</b>	<b>13 - 27</b>
• Propad Profile	13
• Propad Original	15
• Propad Premier	17
• Propad Revolve V	19
• Propad Revolve Si	23
• Propad Revolve Spares	25
<b>Matrx Flo-tech cushions</b>	<b>29 - 67</b>
• Matrx Mini PS	29
• Matrx Flo-tech Lite	31
• Matrx Flo-tech Lite Visco Soft	33
• Matrx Flo-tech Lite Visco Medium	35
• Matrx Flo-tech Lite Visco Firm	37
• Matrx Flo-tech Contour	39
• Matrx Flo-tech Contour Lo-back	41
• Matrx Flo-tech Contour Low Profile	43
• Matrx Flo-tech Contour Visco Soft	45
• Matrx Flo-tech Contour Visco Medium	47
• Matrx Flo-tech Contour Visco Firm	49
• Matrx Flo-tech Contour Visco Very-firm	51
• Matrx Vi	53
• Matrx Flo-tech Plus	55
• Matrx Flo-tech Image	57
• Matrx Flo-tech Solution	59
• Matrx Flo-tech Deep Solution	61
• Matrx Flo-tech Solution Xtra	63
• Matrx Libra	65
<b>Vicair cushions</b>	<b>69 - 101</b>
▪ Vicair Liberty	69
▪ Vicair Liberty TC	71
▪ Vicair Positioner	73
▪ Vicair Twin O2	75

▪ Vicair Adjuster O2	77
▪ Vicair Adjuster 12 O2	79
▪ Vicair Multifunctional O2	81
▪ Vicair Xxtra O2	83
▪ Vicair Pommel O2	85
▪ Vicair Centre Relief O2	87
▪ Vicair Vector O2	89
▪ Vicair Vector Junior O2	91
▪ Vicair Active O2	93
▪ Vicair Allrounder O2	95
▪ Vicair Asymmetrical O2	97
▪ Vicair spares	99

**Vicair back cushions** **103 - 111**

▪ Vicair Butterfly	103
▪ Vicair Liberty	105
▪ Vicair Anatomic	107
▪ Vicair Multifunctional O2	109
▪ Vicair Flex back	111

**Matrx backs** **113 - 140**

▪ Matrx Flo-tech back support	113
▪ Matrx MX2	115
▪ Matrx Mini back	117
▪ Matrx Elite	119
▪ Matrx Elite Deep	123
▪ Matrx Elite Full back	125
▪ Matrx Elite TR	127
▪ Matrx Posture Back (PB)	129
▪ Matrx Posture Back Deep	131
▪ Matrx Posture Back heavy-duty	133
▪ Matrx Posture Back heavy-duty Deep	135
▪ Matrx backs spares	137

**Matrx Elan headrest** **141 - 143**

**Bodypoint accessories** **145 - 149**

**Protech range** **151 - 168**

▪ Belts & harnesses	151
▪ Spares and accessories	155

**Freedom Seating** **169 - 174**



Tel: 01656 776222 Fax: 01656 776220  
Email: ordersuk@invacare.com  
www.invacare.co.uk

<b>Customer name:</b>	<b>Account No :</b>
<b>Contact no:</b>	<b>Order No :</b>
<b>Delivery address:</b>	<b>Order Qty :</b>
	<b>Order Date :</b>

**WCCU Cushions**  
Retail order form

Code	X	Description	Quantity (Min 20)	Net price
<b>2" basic cushion</b>				
WCCU12/14/LP		12 x 14 x2" WCCU low profile cushion		£6.70
WCCU13/15/LP		13 x 15 x2" WCCU low profile cushion		£6.70
WCCU15/16/LP		15 x 16 x2" WCCU low profile cushion		£6.70
WCCU15/17/LP		15 x 17 x2" WCCU low profile cushion		£6.70
WCCU16/LP		16 x 16 x2" WCCU low profile cushion		£6.70
WCCU16/18/LP		16 x 18 x2" WCCU low profile cushion		£6.70
WCCU17/LP		17 x 17 x2" WCCU low profile cushion		£6.70
WCCU18/LP		18 x 16 x2" WCCU low profile cushion		£6.70
WCCU18/17/LP		18 x 17 x2" WCCU low profile cushion		£6.70
WCCU19/17/LP		19 x 17 x2" WCCU low profile cushion		£6.70
WCCU20/17/LP		20 x 17 x2" WCCU low profile cushion		£6.70
<b>3" basic cushion</b>				
WCCU12/14		12 x 14 x3" WCCU cushion		£7.70
WCCU13/15		13 x 15 x3" WCCU cushion		£7.70
WCCU15/16		15 x 16 x3" WCCU cushion		£7.70
WCCU15/17		15 x 17 x3" WCCU cushion		£7.70
WCCU16		16 x 16 x3" WCCU cushion		£7.70
WCCU16/18		16 x 18 x3" WCCU cushion		£7.70
WCCU17		17 x 17 x3" WCCU cushion		£7.70
WCCU18		18 x 16 x3" WCCU cushion		£7.70
WCCU18/17		18 x 17 x3" WCCU cushion		£7.70
WCCU19/17		19 x 17 x3" WCCU cushion		£7.70
WCCU20/17		20 x 17 x3" WCCU cushion		£7.70

**Special Instructions - Please supply the following information:**

**Name:** \_\_\_\_\_ **Email:** \_\_\_\_\_ **Phone:** \_\_\_\_\_

**Description of special request (please include relevant option code):**



Tel: 01656 776222 Fax: 01656 776220  
Email: ordersuk@invacare.com  
www.invacare.co.uk

<b>Customer name:</b>	<b>Account No :</b>
<b>Contact no:</b>	<b>Order No :</b>
<b>Delivery address:</b>	<b>Order Qty :</b>
	<b>Order Date :</b>

**Essential Cushion**  
Retail order form  
Maximum User Weight 108kg (17 stone)

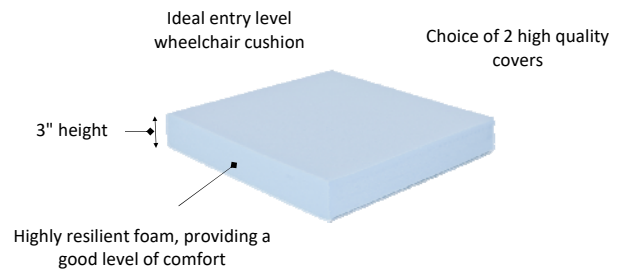
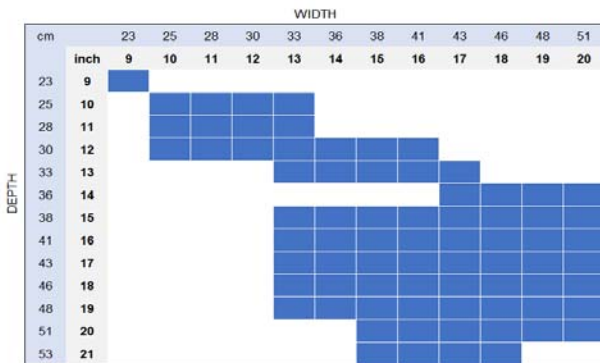

**Features:**  
Comfort cushion  
3" High-density foam  
Black ingress resistant fabric cover  
Sewn cover with zip  
1 year warranty



Code	X	Description	Price
<b>Invacare Essential cushion</b>			
HES0002		Complete Cushion	£42
HES0003		Cover Only	£24
HES0004		Foam Only	£18
HES0005		Pack of 3 Platillon Liners	£11
<b>Foam Type</b>			
HES0006		Standard 3 inch Foam	◆
<b>Seat Width</b>			
HES0027		23cm (9 Inches)	○
HES0028		25 cm (10 Inches)	○
HES0029		28cm (11 Inches)	○
HES0030		30cm (12 Inches)	○
HES0009		33cm (13 Inches)	○
HES0010		36cm (14 Inches)	○
HES0011		38cm (15 Inches)	○
HES0012		41cm (16 Inches)	○
HES0013		43cm (17 Inches)	○
HES0014		46cm (18 Inches)	○
HES0015		48cm (19 Inches)	○
HES0016		51cm (20 inches)	○

Seat Depth			
HES0031		23cm (9 Inches) nc 28, 29, 30, 9, 10, 11, 12, 13, 14, 15, 16	○
HES0032		25 cm (10 Inches) nc 27, 10, 11, 12, 13, 14, 15, 16	○
HES0033		28cm (11 Inches) nc 27, 10, 11, 12, 13, 14, 15, 16	○
HES0034		30cm (12 Inches) nc 27, 13, 14, 15, 16	○
HES0035		33cm (13 Inches) nc 27, 28, 29, 30, 14, 15, 16	○
HES0017		36cm (14 Inches) nc 27, 28, 29, 30, 13, 14, 15, 16	○
HES0018		38cm (15 Inches) nc 27, 28, 29, 30	○
HES0019		41cm (16 Inches) nc 27, 28, 29, 30	○
HES0020		43cm (17 Inches) nc 27, 28, 29, 30	○
HES0021		46cm (18 Inches) nc 27, 28, 29, 30	○
HES0036		48cm (19 inches) nc 27, 28, 29, 30, 09, 10	○
HES0037		51 cm (20 inches) nc 27, 28, 29, 30, 09, 10	○
HES0038		53 cm (21 inches) 27, 28, 29, 30, 09, 10, 15, 16	○
Base Type			
HES0022		Flat Base	◆
Fabric Type			
HES0023		Black Smooth Cover	◆
HES0039		Black Wipedown	○
Cover Type			
HES0024		Sewn Cover	◆
Liner			
HES0025		Platilon Liner Covering Foam (nc 3, 5)	£6
HES0026		No Platilon Liner Required	○
			<b>Total Price</b>
			<b>Quantity</b>
Accessories			
1494494		Rigidiser W14" x D16"	£37
1487165		Rigidiser W16" x D16"	£37
1494495		Rigidiser W16" x D18"	£37
1494496		Rigidiser W16" x D20"	£72
1494497		Rigidiser W18" x D16"	£37
1494498		Rigidiser W18" x D18"	£37
1494499		Rigidiser W18" x D20"	£72
1494500		Rigidiser W20" x D16"	£37
1494501		Rigidiser W20" x D18"	£37
1494502		Rigidiser W20" x D20"	£72
1494503		Rigidiser W22" x D18"	£72
1494504		Rigidiser W22" x D20"	£72
<b>Office use only: Process cushion on configurator and accessories as line items.</b>			





Tel: 01656 776222 Fax: 01656 776220  
Email: ordersuk@invacare.com  
www.invacare.co.uk

<b>Customer name:</b>	<b>Account No :</b>
<b>Contact no:</b>	<b>Order No :</b>
<b>Delivery address:</b>	<b>Order Qty :</b>
	<b>Order Date :</b>

**Essential Low Profile  
Retail order form  
Maximum User Weight 100kg (16 stone)**

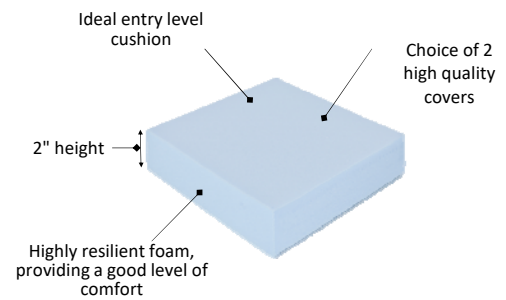
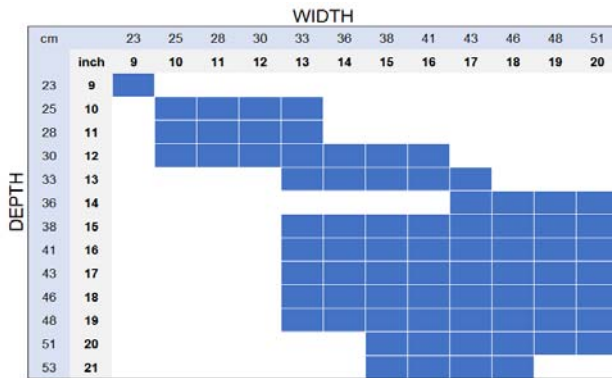

**Features**  
2" Low Profile  
Comfort cushion  
Black ingress resistant fabric cover  
Sewn cover with zip

Code	X	Description	Price
<b>Essential Low profile</b>			
HEL0002		Complete Cushion	£37
HEL0003		Cover Only	£24
HEL0004		Foam Only	£11
HEL0005		Pack of 3 Platillon Liners	£11
<b>Foam Type</b>			
HEL0007		Low Profile 2 inch Foam	◆
<b>Seat Width</b>			
HEL0027		23cm (9 Inches)	○
HEL0028		25 cm (10 Inches)	○
HEL0029		28cm (11 Inches)	○
HEL0030		30cm (12 Inches)	○
HEL0009		33cm (13 Inches)	○
HEL0010		36cm (14 Inches)	○
HEL0011		38cm (15 Inches)	○
HEL0012		41cm (16 Inches)	○
HEL0013		43cm (17 Inches)	○
HEL0014		46cm (18 Inches)	○

HEL0015	48cm (19 Inches)	○
HEL0016	51cm (20 inches)	○
<b>Seat Depth</b>		
HEL0031	23cm (9 Inches) nc 28, 29, 30, 9, 10, 11, 12, 13, 14, 15, 16	○
HEL0032	25 cm (10 Inches) nc 27, 10, 11, 12, 13, 14, 15, 16	○
HEL0033	28cm (11 Inches) nc 27, 10, 11, 12, 13, 14, 15, 16	○
HEL0034	30cm (12 Inches) nc 27, 13, 14, 15, 16	○
HEL0035	33cm (13 Inches) nc 27, 28, 29, 30, 14, 15, 16	○
HEL0017	36cm (14 Inches) nc 27, 28, 29, 30, 13, 14, 15, 16	○
HEL0018	38cm (15 Inches) nc 27, 28, 29, 30	○
HEL0019	41 cm (16 Inches) nc 27,28,29,30	○
HEL0020	43cm (17 Inches) nc 27, 28, 29, 30	○
HEL0021	46cm (18 Inches) nc 27, 28, 29, 30	○
HEL0036	48cm (19 inches) nc 27, 28, 29, 30, 09, 10	○
HEL0037	51 cm (20 inches) nc 27,28,29,30,09,10	○
HEL0038	53 cm (21 inches) 27, 28, 29, 30, 09, 10, 15, 16	○
<b>Base Type</b>		
HEL0022	Flat Base	◆
<b>Fabric Type</b>		
HEL0023	Black Smooth Cover	◆
HEL0039	Black Wipedown	○
<b>Cover Type</b>		
HEL0024	Sewn Cover	◆
<b>Liner</b>		
HEL0025	Platilon Liner Covering Foam (nc 3, 5)	£6
HEL0026	No Platilon Liner Required	◆
		<b>Total Price</b>
		<b>Quantity</b>
<b>Accessories</b>		
1494494	Rigidiser W14" x D16"	£37
1487165	Rigidiser W16" x D16"	£37
1494495	Rigidiser W16" x D18"	£37
1494496	Rigidiser W16" x D20"	£72
1494497	Rigidiser W18" x D16"	£37
1494498	Rigidiser W18" x D18"	£37
1494499	Rigidiser W18" x D20"	£72
1494500	Rigidiser W20" x D16"	£37
1494501	Rigidiser W20" x D18"	£37
1494502	Rigidiser W20" x D20"	£72
1494503	Rigidiser W22" x D18"	£72
1494504	Rigidiser W22" x D20"	£72
<b>Office use only: Process cushion on configurator and accessories as line items.</b>		



Yes, you can.®

Tel: 01656 776222 Fax: 01656 776220  
 Email: ordersuk@invacare.com  
 www.invacare.co.uk

Essential Visco cushion  
 April 2020

<b>Customer name:</b>	<b>Account No :</b>
<b>Contact no:</b>	<b>Order No :</b>
<b>Delivery address:</b>	<b>Order Qty :</b>
	<b>Order Date :</b>

**Essential Visco**  
 Retail order form  
 Maximum User Weight 108kg (17 stone)

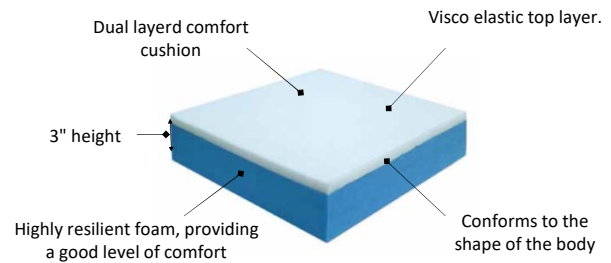
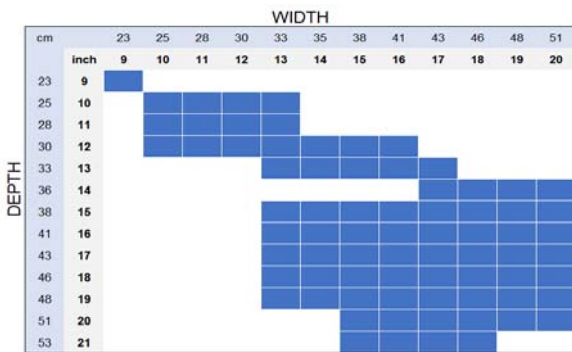

**Features**  
 Comfort cushion  
 3" Visco Elastic Foam  
 Black ingress resistant fabric cover  
 Sewn cover with zip

Code	X	Description	Price
<b>Essential Visco cushion</b>			
HEV0002		Complete Cushion	£46
HEV0003		Cover Only	£29
HEV0004		Foam Only	£19
HEV0005		Pack of 3 Platillon Liners	£11
<b>Foam Type</b>			
HEV0008		Visco 3 inch Foam	◆
<b>Seat Width</b>			
HEV0027		23cm (9 Inches)	○
HEV0028		25 cm (10 Inches)	○
HEV0029		28cm (11 Inches)	○
HEV0030		30cm (12 Inches)	○
HEV0009		33cm (13 Inches)	○
HEV0010		36cm (14 Inches)	○
HEV0011		38cm (15 Inches)	○
HEV0012		41cm (16 Inches)	○
HEV0013		43cm (17 Inches)	○
HEV0014		46cm (18 Inches)	○
HEV0015		48cm (19 Inches)	○
HEV0016		51cm (20 inches)	○

Seat Depth			
HEV0031		23cm (9 Inches) nc 28,29,30, 9,10,11,12,13,14,15,16,	○
HEV0032		25 cm (10 Inches) nc 27,10,11,12,13,14,15,16	○
HEV0033		28cm (11 Inches) nc 27,10,11,12,13,14,15,16	○
HEV0034		30cm (12 Inches) nc 27,13,14,15,16	○
HEV0035		33cm (13 Inches) nc 27,28,29,30,14,15,16	○
HEV0017		36cm (14 Inches) nc 27,28,29,30,13,14,15,16	○
HEV0018		38cm (15 Inches) nc 27,28,29,30,	○
HEV0019		41cm (16 Inches) nc 27,28,29,30	○
HEV0020		43cm (17 Inches) nc 27,28,29,30	○
HEV0021		46cm (18 Inches) nc 27,28,29,30	○
HEV0036		48cm (19 inches) nc 27,28,29,30,09,10	○
HEV0037		51 cm (20 inches) nc 27,28,29,30,09,10	○
HEV0038		53 cm (21 inches) 27,28,29,30,09,10,15,16	○
Base Type			
HEV0022		Flat Base	◆
Fabric Cover			
HEV0023		Black Smooth Cover	◆
HEV0039		Black Wipedown	○
Cover Type			
HEV0024		Sewn Cover	◆
Liner			
HEV0025		Platillon Liner Covering Foam (nc 3, 5)	£6
HEV0026		No Platillon Liner Required	◆
			<b>Total Price</b>
			<b>Quantity</b>
Accessories			
1494494		Rigidiser W14" x D16"	£37
1487165		Rigidiser W16" x D16"	£37
1494495		Rigidiser W16" x D18"	£37
1494496		Rigidiser W16" x D20"	£72
1494497		Rigidiser W18" x D16"	£37
1494498		Rigidiser W18" x D18"	£37
1494499		Rigidiser W18" x D20"	£72
1494500		Rigidiser W20" x D16"	£37
1494501		Rigidiser W20" x D18"	£37
1494502		Rigidiser W20" x D20"	£72
1494503		Rigidiser W22" x D18"	£72
1494504		Rigidiser W22" x D20"	£72
			Total Price:
<b>Office use only: Process cushion on configurator and accessories as line items.</b>			

Tel: 01656 776222 Fax: 01656 776220  
Email: ordersuk@invacare.com  
Online spares available at www.invacare.co.uk

<b>Customer name:</b>	<b>Account No :</b>
<b>Contact no:</b>	<b>Order No :</b>
<b>Delivery address:</b>	<b>Order Qty :</b>
	<b>Order Date :</b>

**Propad Profile**  
Retail order form  
Maximum User Weight 127kg (20 stone)

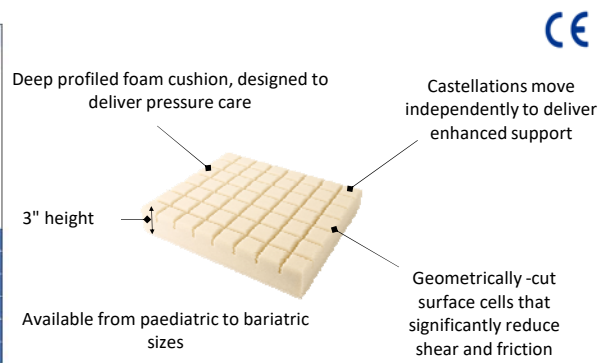
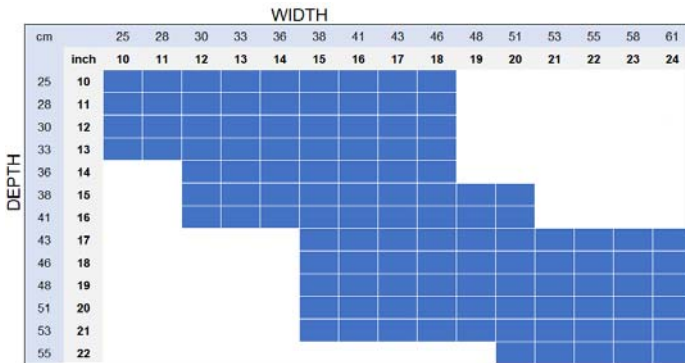

**Features:**  
Entry level pressure care  
3" Castellated Foam  
Multi stretch vapour permeable cover  
Full length flap concealing zip  
1 year warranty



Code	X	Description	Price
<b>Propad profile</b>			
HPL0002		Complete Cushion	£50
HPL0003		Cover Only	£29
HPL0004		Foam Only	£22
<b>Foam Type</b>			
HPL0005		3" (7.5cm) Castellated Foam (nc 3)	◆
<b>Seat Width</b>			
HPL0007		25cm (10 Inches) (nc 26, 27, 28, 29, 30, 31, 32, 33, 34)	○
HPL0008		28cm (11 Inches) (nc 26, 27, 28, 29, 30, 31, 32, 33, 34)	○
HPL0009		30cm (12 Inches) (nc 29, 30, 31, 32, 33, 34)	○
HPL0010		33cm (13 Inches) (nc 22, 23, 24, 29, 30, 31, 32, 33, 34)	○
HPL0011		36cm (14 Inches) (nc 22, 23, 24, 29, 30, 31, 32, 33, 34)	○
HPL0012		38cm (15 Inches) (nc 22, 23, 24, 34)	○
HPL0013		41cm (16 Inches) (nc 22, 23, 24, 34)	○
HPL0014		43cm (17 Inches) (nc 22, 23, 24, 34)	○

HPL0015	46cm (18 Inches) (nc 22, 23, 24, 34)	○
HPL0016	48cm (19 Inches) (nc 22, 23, 24, 25, 26, 34)	○
HPL0017	51cm (20 Inches) (nc 22, 23, 24, 25, 26)	○
HPL0018	53cm (21 Inches) (nc 22, 23, 24, 25, 26, 27, 28)	○
HPL0019	55cm (22 Inches) (nc 22, 23, 24, 25, 26, 27, 28)	○
HPL0020	58cm (23 Inches) (nc 22, 23, 24, 25, 26, 27, 28)	○
HPL0021	60cm (24 Inches) (nc 22, 23, 24, 25, 26, 27, 28)	○
<b>Seat Depth</b>		
HPL0022	25cm (10 Inches)	○
HPL0023	28cm (11 Inches)	○
HPL0024	30cm (12 Inches)	○
HPL0025	33cm (13 Inches)	○
HPL0026	36cm (14 Inches)	○
HPL0027	38cm (15 Inches)	○
HPL0028	41cm (16 Inches)	○
HPL0029	43cm (17 Inches)	○
HPL0030	46cm (18 Inches)	○
HPL0031	48cm (19 Inches)	○
HPL0032	51cm (20 Inches)	○
HPL0033	53cm (21 Inches)	○
HPL0034	55cm (22 Inches)	○
<b>Fabric Type</b>		
HPL0035	Baltic Blue Wipedown Cover	◆
HPL0036	Black Smooth Cover	£13
<b>Cover Branding</b>		
HPL0037	Standard Invacare Branded Cover (nc 4)	◆
<b>Cover Type</b>		
HPL0039	Sewn Cover (nc 4)	◆
<b>Liner</b>		
HPL0040	Platillon Liner Covering Moulded Foam (nc 4)	£6
HPL0041	No Platillon Liner Required	○
<b>Velcro</b>		
HPL0042	Velcro Pieces Sewn On Cover Base (nc 4)	£26
HPL0043	No Velcro Required	◆
<b>Total Price</b>		
<b>Quantity</b>		
<b>Accessories</b>		
1494494	Rigidiser W14" x D16"	£37
1487165	Rigidiser W16" x D16"	£37
1494495	Rigidiser W16" x D18"	£37
1494496	Rigidiser W16" x D20"	£72
1494497	Rigidiser W18" x D16"	£37
1494498	Rigidiser W18" x D18"	£37
1494499	Rigidiser W18" x D20"	£72
1494500	Rigidiser W20" x D16"	£37
1494501	Rigidiser W20" x D18"	£37
1494502	Rigidiser W20" x D20"	£72
1494503	Rigidiser W22" x D18"	£72
1494504	Rigidiser W22" x D20"	£72
<b>Office use only: Process cushion on configurator and accessories as line items.</b>		

Tel: 01656 776222 Fax: 01656 776220  
Email: ordersuk@invacare.com  
Online spares available at www.invacare.co.uk

<b>Account Name :</b>	<b>Account No :</b>
<b>Address :</b>	<b>Order No :</b>
<b>Tel No:</b>	<b>Order Qty :</b>
<b>Delivery address :</b>	<b>Order Date :</b>

**Propad Original**  
Retail order form  
Maximum User Weight 127kg (20 stone)

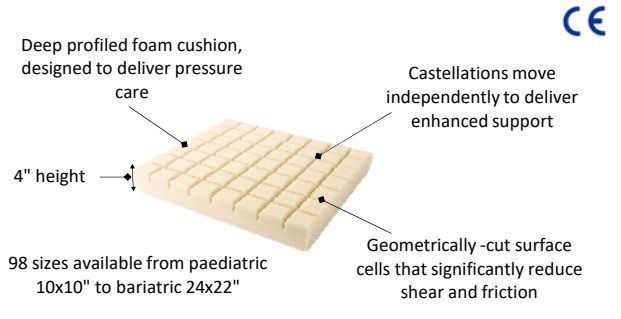
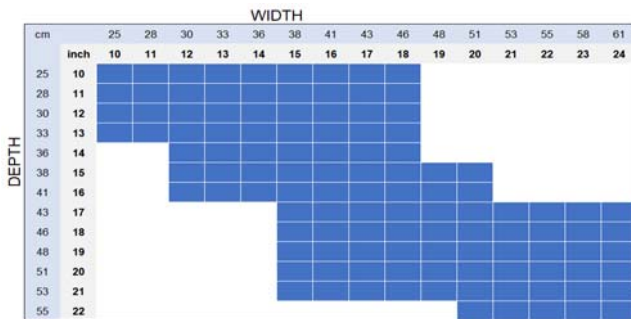

**Features**  
Weight Limit: 20 Stone  
4" Castellated cut foam  
Multi stretch vapour permeable cover  
Full length flap concealing zip



Code	X	Description	Price
<b>Invacare Propad Original</b>			
HPO0002		Complete Cushion	£69
HPO0003		Cover Only	£30
HPO0004		Foam Only	£38
<b>Foam Type</b>			
HPO0005		4" (10cm) Castellated Foam (nc 3)	◆
<b>Seat Width</b>			
HPO0007		25cm (10 Inches) (nc 26, 27, 28, 29, 30, 31, 32, 33, 34)	○
HPO0008		28cm (11 Inches) (nc 26, 27, 28, 29, 30, 31, 32, 33, 34)	○
HPO0009		30cm (12 Inches) (nc 29, 30, 31, 32, 33, 34)	○
HPO0010		33cm (13 Inches) (nc 22, 23, 24, 29, 30, 31, 32, 33, 34)	○
HPO0011		36cm (14 Inches) (nc 22, 23, 24, 29, 30, 31, 32, 33, 34)	○
HPO0012		38cm (15 Inches) (nc 22, 23, 24, 34)	○
HPO0013		41cm (16 Inches) (nc 22, 23, 24, 34)	○
HPO0014		43cm (17 Inches) (nc 22, 23, 24, 34)	○
HPO0015		46cm (18 Inches) (nc 22, 23, 24, 34)	○
HPO0016		48cm (19 Inches) (nc 22, 23, 24, 25, 26, 34)	○

HPO0017	51cm (20 Inches) (nc 22, 23, 24, 25, 26)	○
HPO0018	53cm (21 Inches) (nc 22, 23, 24, 25, 26, 27, 28)	○
HPO0019	55cm (22 Inches) (nc 22, 23, 24, 25, 26, 27, 28)	○
HPO0020	58cm (23 Inches) (nc 22, 23, 24, 25, 26, 27, 28)	○
HPO0021	60cm (24 Inches) (nc 22, 23, 24, 25, 26, 27, 28)	○
<b>Seat Depth</b>		
HPO0022	25cm (10 Inches)	○
HPO0023	28cm (11 Inches)	○
HPO0024	30cm (12 Inches)	○
HPO0025	33cm (13 Inches)	○
HPO0026	36cm (14 Inches)	○
HPO0027	38cm (15 Inches)	○
HPO0028	41cm (16 Inches)	○
HPO0029	43cm (17 Inches)	○
HPO0030	46cm (18 Inches)	○
HPO0031	48cm (19 Inches)	○
HPO0032	51cm (20 Inches)	○
HPO0033	53cm (21 Inches)	○
HPO0034	55cm (22 Inches)	○
<b>Fabric Type</b>		
HPO0035	Baltic Blue Wipedown Cover	◆
HPO0036	Black Smooth Cover	£13
<b>Cover Branding</b>		
HPO0037	Standard Invacare Branded Cover (nc 4)	◆
<b>Cover Type</b>		
HPO0039	Sewn Cover (nc 4)	◆
<b>Liner</b>		
HPO0040	Platillon Liner Covering Moulded Foam (nc 4)	£6
HPO0041	No Platillon Liner Required	○
<b>Velcro</b>		
HPO0042	Velcro Pieces Sewn On Cover Base (nc 4)	£26
HPO0043	No Velcro Required	◆
		<b>Total Price</b>
		<b>Quantity</b>
<b>Accessories</b>		
1494494	Rigidiser W14" x D16"	£37
1487165	Rigidiser W16" x D16"	£37
1494495	Rigidiser W16" x D18"	£37
1494496	Rigidiser W16" x D20"	£72
1494497	Rigidiser W18" x D16"	£37
1494498	Rigidiser W18" x D18"	£37
1494499	Rigidiser W18" x D20"	£72
1494500	Rigidiser W20" x D16"	£37
1494501	Rigidiser W20" x D18"	£37
1494502	Rigidiser W20" x D20"	£72
1494503	Rigidiser W22" x D18"	£72
1494504	Rigidiser W22" x D20"	£72
<b>Office use only: Process cushion on configurator and accessories as line items.</b>		





Yes, you can.®

Propad Premier cushion  
April 2020

Tel: 01656 776222 Fax: 01656 776220  
Email: ordersuk@invacare.com  
Online spares available at www.invacare.co.uk

<b>Customer name:</b>	<b>Account No :</b>
<b>Contact no:</b>	<b>Order No :</b>
<b>Delivery address:</b>	<b>Order Qty :</b>
	<b>Order Date :</b>

**Propad Premier**  
Retail order form  
Maximum User Weight 196kg (31 stone)

		WIDTH											
cm		33	36	38	41	43	46	48	51	53	55	58	61
inch		13	14	15	16	17	18	19	20	21	22	23	24
DEPTH	33	[Grid]											
	36	[Grid]											
	38	[Grid]											
	41	[Grid]											
	43	[Grid]											
	46	[Grid]											
	48	[Grid]											
	51	[Grid]											
53	[Grid]												
55	[Grid]												

Deep profiled foam cushion, with dual layer to deliver comfort and increased stability

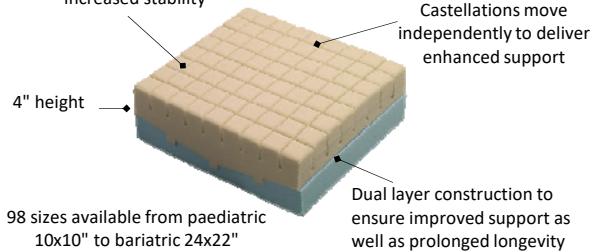

**Features:**  
Weight Limit: 31 Stone  
4" Castellated Foam  
Multi stretch vapour permeable cover  
Full length flap concealing zip  
1 year warranty



Code	X	Description	Price
<b>Propad Premier</b>			
HPM0002		Complete Cushion	£72
HPM0003		Cover Only	£42
HPM0004		Foam Only	£34
<b>Foam Type</b>			
HPM0005		4" (10cm) Propad Premier Foam (nc 3)	◆
<b>Seat Width</b>			
HPM0007		33cm (13 Inches) (nc 24, 25, 26, 27, 28)	○
HPM0008		36cm (14 Inches) (nc 24, 25, 26, 27, 28)	○
HPM0009		38cm (15 Inches) (nc 28)	○
HPM0010		41cm (16 Inches) (nc 28)	○
HPM0011		43cm (17 Inches) (nc 28)	○
HPM0012		46cm (18 Inches) (nc 28)	○
HPM0013		48cm (19 Inches) (nc 19, 20, 28)	○
HPM0014		51cm (20 Inches) (nc 19, 20)	○
HPM0015		53cm (21 Inches) (nc 19, 20, 21, 22)	○
HPM0016		55cm (22 Inches) (nc 19, 20, 21, 22)	○
HPM0017		58cm (23 Inches) (nc 19, 20, 21, 22)	○
HPM0018		60cm (24 Inches) (nc 19, 20, 21, 22)	○

<b>Seat Depth</b>			
HPM0019		33cm (13 Inches)	○
HPM0020		36cm (14 Inches)	○
HPM0021		38cm (15 Inches)	○
HPM0022		41cm (16 Inches)	○
HPM0023		43cm (17 Inches)	○
HPM0024		46cm (18 Inches)	○
HPM0025		48cm (19 Inches)	○
HPM0026		51cm (20 Inches)	○
HPM0027		53cm (21 Inches)	○
HPM0028		55cm (22 Inches)	○
<b>Fabric Type</b>			
HPM0029		Baltic Blue Wipedown Cover	◆
HPM0030		Black Smooth Cover	£13
<b>Cover Branding</b>			
HPM0032		Standard Invacare Branded Cover (nc 4)	◆
<b>Cover Type</b>			
HPM0034		Sewn Cover (nc 4)	◆
<b>Liner</b>			
HPM0035		Platillon Liner Covering Moulded Foam (nc 4)	£6
HPM0036		No Platillon Liner Required	○
<b>Velcro</b>			
HPM0037		Velcro Pieces Sewn On Cover Base (nc 4)	£26
HPM0038		No Velcro Required	◆
			<b>Total Price</b>
			<b>Quantity</b>
<b>Accessories</b>			
1494494		Rigidiser W14" x D16"	£37
1487165		Rigidiser W16" x D16"	£37
1494495		Rigidiser W16" x D18"	£37
1494496		Rigidiser W16" x D20"	£72
1494497		Rigidiser W18" x D16"	£37
1494498		Rigidiser W18" x D18"	£37
1494499		Rigidiser W18" x D20"	£72
1494500		Rigidiser W20" x D16"	£37
1494501		Rigidiser W20" x D18"	£37
1494502		Rigidiser W20" x D20"	£72
1494503		Rigidiser W22" x D18"	£72
1494504		Rigidiser W22" x D20"	£72
<b>Office use only: Process cushion on configurator and accessories as line items.</b>			

Tel: 01656 776222 Fax: 01656 776220  
Email: ordersuk@invacare.com  
www.invacare.co.uk

Propad Revolve V cushion  
April 2020

<b>Customer name:</b>	<b>Account No :</b>
<b>Contact no:</b>	<b>Order No :</b>
<b>Delivery address:</b>	<b>Order Qty :</b>
	<b>Order Date :</b>

**Propad Revolve V (Viscoelastic insert)**  
Retail order form  
Maximum User Weight 190Kg (30 Stone)

		WIDTH										
cm		36	38	41	43	46	48	51	56	61		
inch		14	15	16	17	18	19	20	22	24		
DEPTH	36	14										
	38	15										
	41	16										
	43	17										
	46	18										
	51	20										

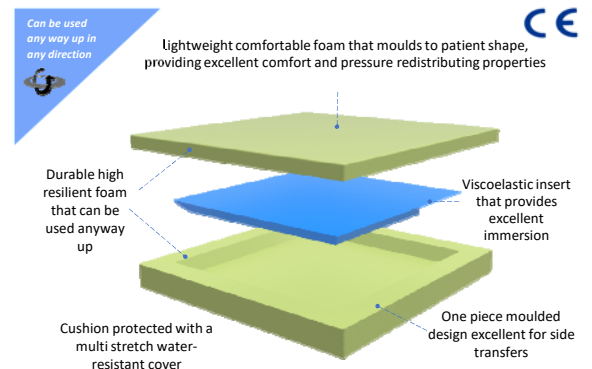

**Features**  
High risk  
3" height  
Flat - any way up  
Foam Visco combination  
Sewn cover  
Weight limit: 30 stone



Code	X	Description	Price
<b>Complete cushion</b>			
1629519		Revolve V without liner 14x14" (36x36cm)	£74
1629520		Revolve V without liner 14x15" (36x38cm)	£74
1629521		Revolve V without liner 14x16" (36x41cm)	£74
1629522		Revolve V without liner 15x14" (38x36cm)	£74
1629523		Revolve V without liner 15x15" (38x38cm)	£74
1629524		Revolve V without liner 15x16" (38x41cm)	£74
1629525		Revolve V without liner 16x14" (41x36cm)	£74
1629526		Revolve V without liner 16x15" (41x38cm)	£74
1602007		Revolve V without liner 16x16" (41x41cm)	£74
1602009		Revolve V without liner 16x18" (41x46cm)	£74
1602008		Revolve V without liner 17x17" (43x43cm)	£74
1602023		Revolve V without liner 18x16" (46x41cm)	£74
1629527		Revolve V without liner 18x17" (46x43cm)	£74
1602024		Revolve V without liner 18x18" (46x46cm)	£74
1602025		Revolve V without liner 19x17" (48x43cm)	£74
1602026		Revolve V without liner 20x18" (51x46cm)	£74
1602504		Revolve V without liner 20x20" (51x51cm)	£74
1630665		Revolve V without liner 22x18" (56x46cm)	£74
1630666		Revolve V without liner 22x20" (56x51cm)	£74
1630667		Revolve V without liner 24x18" (61x46cm)	£74
1630668		Revolve V without liner 24x20" (61x51cm)	£74
1629649		Revolve V without liner 14x14" (36x36cm)	£74
1629650		Revolve V without liner 14x15" (36x38cm)	£74

1629651	Revolve V without liner 14x16" (36x41cm)	Sewn black wipedown cover	£74
1629652	Revolve V without liner 15x14" (38x36cm)	Sewn black wipedown cover	£74
1629653	Revolve V without liner 15x15" (38x38cm)	Sewn black wipedown cover	£74
1629654	Revolve V without liner 15x16" (38x41cm)	Sewn black wipedown cover	£74
1629655	Revolve V without liner 16x14" (41x36cm)	Sewn black wipedown cover	£74
1629656	Revolve V without liner 16x15" (41x38cm)	Sewn black wipedown cover	£74
1627604	Revolve V without liner 16x16" (41x41cm)	Sewn black wipedown cover	£74
1627606	Revolve V without liner 16x18" (41x46cm)	Sewn black wipedown cover	£74
1627605	Revolve V without liner 17x17" (43x43cm)	Sewn black wipedown cover	£74
1627607	Revolve V without liner 18x16" (46x41cm)	Sewn black wipedown cover	£74
1629657	Revolve V without liner 18x17" (46x43cm)	Sewn black wipedown cover	£74
1627608	Revolve V without liner 18x18" (46x46cm)	Sewn black wipedown cover	£74
1627609	Revolve V without liner 19x17" (48x43cm)	Sewn black wipedown cover	£74
1627610	Revolve V without liner 20x18" (51x46cm)	Sewn black wipedown cover	£74
1627611	Revolve V without liner 20x20" (51x51cm)	Sewn black wipedown cover	£74
1630685	Revolve V without liner 22x18" (56x46cm)	Sewn black wipeown cover	£74
1630686	Revolve V without liner 22x20" (56x51cm)	Sewn black wipeown cover	£74
1630687	Revolve V without liner 24x18" (61x46cm)	Sewn black wipeown cover	£74
1630688	Revolve V without liner 24x20" (61x51cm)	Sewn black wipeown cover	£74
1629528	Revolve V with platilon liner 14x14" (36x36cm)	Sewn blue wipedown cover	£83
1629529	Revolve V with platilon liner 14x15" (36x38cm)	Sewn blue wipedown cover	£83
1629530	Revolve V with platilon liner 14x16" (36x41cm)	Sewn blue wipedown cover	£83
1629531	Revolve V with platilon liner 15x14" (38x36cm)	Sewn blue wipedown cover	£83
1629532	Revolve V with platilon liner 15x15" (38x38cm)	Sewn blue wipedown cover	£83
1629533	Revolve V with platilon liner 15x16" (38x41cm)	Sewn blue wipedown cover	£83
1629534	Revolve V with platilon liner 16x14" (41x36cm)	Sewn blue wipedown cover	£83
1629535	Revolve V with platilon liner 16x15" (41x38cm)	Sewn blue wipedown cover	£83
1603212	Revolve V with platilon liner 16x16" (41x41cm)	Sewn blue wipedown cover	£83
1603214	Revolve V with platilon liner 16x18" (41x46cm)	Sewn blue wipedown cover	£83
1603213	Revolve V with platilon liner 17x17" (43x43cm)	Sewn blue wipedown cover	£83
1603215	Revolve V with platilon liner 18x16" (46x41cm)	Sewn blue wipedown cover	£83
1629536	Revolve V with platilon liner 18x17" (46x43cm)	Sewn blue wipedown cover	£83
1603216	Revolve V with platilon liner 18x18" (46x46cm)	Sewn blue wipedown cover	£83
1603217	Revolve V with platilon liner 19x17" (48x43cm)	Sewn blue wipedown cover	£83
1603228	Revolve V with platilon liner 20x18" (51x46cm)	Sewn blue wipedown cover	£83
1603229	Revolve V with platilon liner 20x20" (51x51cm)	Sewn blue wipedown cover	£83
1630669	Revolve V with platilon liner 22x18" (56x46cm)	Sewn blue wipeown cover	£83
1630670	Revolve V with platilon liner 22x20" (56x51cm)	Sewn blue wipeown cover	£83
1630671	Revolve V with platilon liner 24x18" (61x46cm)	Sewn blue wipeown cover	£83
1630672	Revolve V with platilon liner 24x20" (61x51cm)	Sewn blue wipeown cover	£83
1629658	Revolve V with platilon liner 14x14" (36x36cm)	Sewn black wipedown cover	£83
1629659	Revolve V with platilon liner 14x15" (36x38cm)	Sewn black wipedown cover	£83
1629660	Revolve V with platilon liner 14x16" (36x41cm)	Sewn black wipedown cover	£83
1629661	Revolve V with platilon liner 15x14" (38x36cm)	Sewn black wipedown cover	£83
1629662	Revolve V with platilon liner 15x15" (38x38cm)	Sewn black wipedown cover	£83
1629663	Revolve V with platilon liner 15x16" (38x41cm)	Sewn black wipedown cover	£83
1629664	Revolve V with platilon liner 16x14" (41x36cm)	Sewn black wipedown cover	£83
1629665	Revolve V with platilon liner 16x15" (41x38cm)	Sewn black wipedown cover	£83
1627612	Revolve V with platilon liner 16x16" (41x41cm)	Sewn black wipedown cover	£83
1627614	Revolve V with platilon liner 16x18" (41x46cm)	Sewn black wipedown cover	£83
1627613	Revolve V with platilon liner 17x17" (43x43cm)	Sewn black wipedown cover	£83
1627615	Revolve V with platilon liner 18x16" (46x41cm)	Sewn black wipedown cover	£83
1629666	Revolve V with platilon liner 18x17" (46x43cm)	Sewn black wipedown cover	£83
1627616	Revolve V with platilon liner 18x18" (46x46cm)	Sewn black wipedown cover	£83
1627617	Revolve V with platilon liner 19x17" (48x43cm)	Sewn black wipedown cover	£83
1627618	Revolve V with platilon liner 20x18" (51x46cm)	Sewn black wipedown cover	£83
1627619	Revolve V with platilon liner 20x20" (51x51cm)	Sewn black wipedown cover	£83
1630689	Revolve V with platilon liner 22x18" (56x46cm)	Sewn black wipeown cover	£83
1630690	Revolve V with platilon liner 22x20" (56x51cm)	Sewn black wipeown cover	£83
1630691	Revolve V with platilon liner 24x18" (61x46cm)	Sewn black wipeown cover	£83
1630692	Revolve V with platilon liner 24x20" (61x51cm)	Sewn black wipeown cover	£83
1629591	Revolve V with Aquaguard zip 14x14" (36x36cm)	Welded baltic blue wipeown cover	£91
1629592	Revolve V with Aquaguard zip 14x15" (36x38cm)	Welded baltic blue wipeown cover	£91
1629593	Revolve V with Aquaguard zip 14x16" (36x41cm)	Welded baltic blue wipeown cover	£91
1629594	Revolve V with Aquaguard zip 15x14" (38x36cm)	Welded baltic blue wipeown cover	£91
1629595	Revolve V with Aquaguard zip 15x15" (38x38cm)	Welded baltic blue wipeown cover	£91
1629596	Revolve V with Aquaguard zip 15x16" (38x41cm)	Welded baltic blue wipeown cover	£91
1629597	Revolve V with Aquaguard zip 16x14" (41x36cm)	Welded baltic blue wipeown cover	£91
1629598	Revolve V with Aquaguard zip 16x15" (41x38cm)	Welded baltic blue wipeown cover	£91

1602145	Revolve V with Aquaguard zip 16x16" (41x41cm)	Welded baltic blue wipeown cover	£91
1602147	Revolve V with Aquaguard zip 16x18" (41x46cm)	Welded baltic blue wipeown cover	£91
1602146	Revolve V with Aquaguard zip 17x17" (43x43cm)	Welded baltic blue wipeown cover	£91
1602148	Revolve V with Aquaguard zip 18x16" (46x41cm)	Welded baltic blue wipeown cover	£91
1629599	Revolve V with Aquaguard zip 18x17" (46x43cm)	Welded baltic blue wipeown cover	£91
1602149	Revolve V with Aquaguard zip 18x18" (46x46cm)	Welded baltic blue wipeown cover	£91
1602150	Revolve V with Aquaguard zip 19x17" (48x43cm)	Welded baltic blue wipeown cover	£91
1602151	Revolve V with Aquaguard zip 20x18" (51x46cm)	Welded baltic blue wipeown cover	£91
1602616	Revolve V with Aquaguard zip 20x20" (51x51cm)	Welded baltic blue wipeown cover	£91
1630677	Revolve V with Aquaguard zip 22x18" (56x46cm)	Welded baltic blue wipeown cover	£91
1630678	Revolve V with Aquaguard zip 22x20" (56x51cm)	Welded baltic blue wipeown cover	£91
1630679	Revolve V with Aquaguard zip 24x18" (61x46cm)	Welded baltic blue wipeown cover	£91
1630680	Revolve V with Aquaguard zip 24x20" (61x51cm)	Welded baltic blue wipeown cover	£91
<b>TOTAL PRICE:</b>			

**Special Instructions - Extended lead times will apply**



**Name:**

**Email:**

**Phone:**

**Description of special request (please include relevant option code):**



Tel: 01656 776222 Fax: 01656 776220  
Email: ordersuk@invacare.com  
www.invacare.co.uk

Propad Revolve Si cushion  
April 2020

<b>Customer name:</b>	<b>Account No :</b>
<b>Contact no:</b>	<b>Order No :</b>
<b>Delivery address:</b>	<b>Order Qty :</b>
	<b>Order Date :</b>

**Propad Revolve Si (Silicon gel insert)**  
Retail order Form  
Maximum User Weight 190Kg (30 Stone)

		WIDTH									
cm		36	38	41	43	46	48	51	56	61	
inch		14	15	16	17	18	19	20	22	24	
DEPTH	36	■									
	38	■									
	41	■									
	43				■	■	■				
	46					■	■				
51								■	■	■	

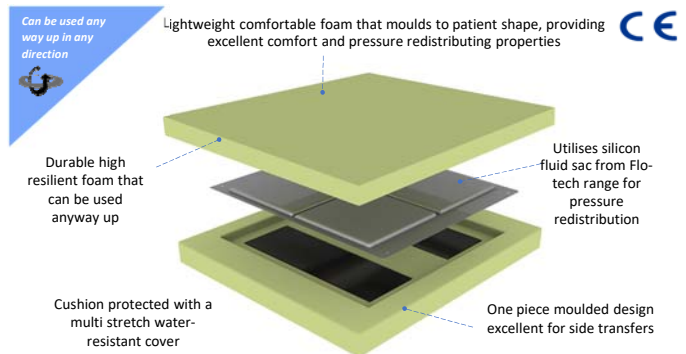

**Standard features:**

- High risk
- 3" height
- Flat - any way up
- Foam and fluid combination
- Sewn cover
- Weight limit: 30 stone



Code	X	Description	Price
<b>Complete cushion</b>			
1629479		Revolve Si with platilon liner 14x14" (36x36cm)	£157
1629480		Revolve Si with platilon liner 14x15" (36x38cm)	£157
1629481		Revolve Si with platilon liner 14x16" (36x41cm)	£157
1629482		Revolve Si with platilon liner 15x14" (38x36cm)	£157
1629483		Revolve Si with platilon liner 15x15" (38x38cm)	£157
1629484		Revolve Si with platilon liner 15x16" (38x41cm)	£157
1629485		Revolve Si with platilon liner 16x14" (41x36cm)	£157
1629486		Revolve Si with platilon liner 16x15" (41x38cm)	£157
1601977		Revolve Si with platilon liner 16x16" (41x41cm)	£157
1601994		Revolve Si with platilon liner 16x18" (41x46cm)	£157
1601993		Revolve Si with platilon liner 17x17" (43x43cm)	£157
1601995		Revolve Si with platilon liner 18x16" (46x41cm)	£157
1629487		Revolve Si with platilon liner 18x17" (46x43cm)	£157
1601996		Revolve Si with platilon liner 18x18" (46x46cm)	£157
1601997		Revolve Si with platilon liner 19x17" (48x43cm)	£157
1601998		Revolve Si with platilon liner 20x18" (51x46cm)	£157
1602472		Revolve Si with platilon liner 20x20" (51x51cm)	£157
1630661		Revolve Si with platilon liner 22x18" (56x46cm)	£157
1630662		Revolve Si with platilon liner 22x20" (56x51cm)	£157
1630663		Revolve Si with platilon liner 24x18" (61x46cm)	£157
1630664		Revolve Si with platilon liner 24x20" (61x51cm)	£157

1629621	Revolve Si with platilon liner 14x14" (36x36cm)	Sewn black wipedown cover	£157
1629622	Revolve Si with platilon liner 14x15" (36x38cm)	Sewn black wipedown cover	£157
1629623	Revolve Si with platilon liner 14x16" (36x41cm)	Sewn black wipedown cover	£157
1629624	Revolve Si with platilon liner 15x14" (38x36cm)	Sewn black wipedown cover	£157
1629625	Revolve Si with platilon liner 15x15" (38x38cm)	Sewn black wipedown cover	£157
1629626	Revolve Si with platilon liner 15x16" (38x41cm)	Sewn black wipedown cover	£157
1629627	Revolve Si with platilon liner 16x14" (41x36cm)	Sewn black wipedown cover	£157
1629628	Revolve Si with platilon liner 16x15" (41x38cm)	Sewn black wipedown cover	£157
1627596	Revolve Si with platilon liner 16x16" (41x41cm)	Sewn black wipedown cover	£157
1627598	Revolve Si with platilon liner 16x18" (41x46cm)	Sewn black wipedown cover	£157
1627597	Revolve Si with platilon liner 17x17" (43x43cm)	Sewn black wipedown cover	£157
1627599	Revolve Si with platilon liner 18x16" (46x41cm)	Sewn black wipedown cover	£157
1629629	Revolve Si with platilon liner 18x17" (46x43cm)	Sewn black wipedown cover	£157
1627600	Revolve Si with platilon liner 18x18" (46x46cm)	Sewn black wipedown cover	£157
1627601	Revolve Si with platilon liner 19x17" (48x43cm)	Sewn black wipedown cover	£157
1627602	Revolve Si with platilon liner 20x18" (51x46cm)	Sewn black wipedown cover	£157
1627603	Revolve Si with platilon liner 20x20" (51x51cm)	Sewn black wipedown cover	£157
1630681	Revolve Si with platilon liner 22x18" (56x46cm)	Sewn black wipedown cover	£157
1630682	Revolve Si with platilon liner 22x20" (56x51cm)	Sewn black wipedown cover	£157
1630683	Revolve Si with platilon liner 24x18" (61x46cm)	Sewn black wipedown cover	£157
1630684	Revolve Si with platilon liner 24x20" (61x51cm)	Sewn black wipedown cover	£157
1629562	Revolve Si with Aquaguard zip 14x14" (36x36cm)	Welded baltic blue wipedown cover	£173
1629563	Revolve Si with Aquaguard zip 14x15" (36x38cm)	Welded baltic blue wipedown cover	£173
1629564	Revolve Si with Aquaguard zip 14x16" (36x41cm)	Welded baltic blue wipedown cover	£173
1629565	Revolve Si with Aquaguard zip 15x14" (38x36cm)	Welded baltic blue wipedown cover	£173
1629566	Revolve Si with Aquaguard zip 15x15" (38x38cm)	Welded baltic blue wipedown cover	£173
1629567	Revolve Si with Aquaguard zip 15x16" (38x41cm)	Welded baltic blue wipedown cover	£173
1629568	Revolve Si with Aquaguard zip 16x14" (41x36cm)	Welded baltic blue wipedown cover	£173
1629569	Revolve Si with Aquaguard zip 16x15" (41x38cm)	Welded baltic blue wipedown cover	£173
1602138	Revolve Si with Aquaguard zip 16x16" (41x41cm)	Welded baltic blue wipedown cover	£173
1602140	Revolve Si with Aquaguard zip 16x18" (41x46cm)	Welded baltic blue wipedown cover	£173
1602139	Revolve Si with Aquaguard zip 17x17" (43x43cm)	Welded baltic blue wipedown cover	£173
1602141	Revolve Si with Aquaguard zip 18x16" (46x41cm)	Welded baltic blue wipedown cover	£173
1629570	Revolve Si with Aquaguard zip 18x17" (46x46cm)	Welded baltic blue wipedown cover	£173
1602142	Revolve Si with Aquaguard zip 18x18" (46x46cm)	Welded baltic blue wipedown cover	£173
1602143	Revolve Si with Aquaguard zip 19x17" (48x43cm)	Welded baltic blue wipedown cover	£173
1602144	Revolve Si with Aquaguard zip 20x18" (51x46cm)	Welded baltic blue wipedown cover	£173
1602615	Revolve Si with Aquaguard zip 20x20" (51x51cm)	Welded baltic blue wipedown cover	£173
1630673	Revolve Si with Aquaguard zip 22x18" (56x46cm)	Welded baltic blue wipeown cover	£173
1630674	Revolve Si with Aquaguard zip 22x20" (56x51cm)	Welded baltic blue wipeown cover	£173
1630675	Revolve Si with Aquaguard zip 24x18" (61x46cm)	Welded baltic blue wipeown cover	£173
1630676	Revolve Si with Aquaguard zip 24x20" (61x51cm)	Welded baltic blue wipeown cover	£173

**TOTAL PRICE:**

**Special Instructions - Extended lead times will apply**

**Name:**

**Email:**

**Phone:**



**Description of special request (please include relevant option code):**





Tel: 01656 776222 Fax: 01656 776220  
Email: ordersuk@invacare.com  
www.invacare.co.uk

<b>Customer name:</b>	<b>Account No :</b>
<b>Contact no:</b>	<b>Order No :</b>
<b>Delivery address:</b>	<b>Order Qty :</b>
	<b>Order Date :</b>

**Propad Revolve spares  
Retail order form**

Code	X	Description	Price
<b>Propad Revolve spares</b>			
SP1629450		Spare platilon liner (2 pack)	14 x 14" (36x36cm) £11
SP1629451		Spare platilon liner (2 pack)	14 x 15" (36x38cm) £11
SP1629452		Spare platilon liner (2 pack)	14 x 16" (36x41cm) £11
SP1629453		Spare platilon liner (2 pack)	15 x 14" (38x36cm) £11
SP1629454		Spare platilon liner (2 pack)	15 x 15" (38x38cm) £11
SP1629455		Spare platilon liner (2 pack)	15 x 16" (38x41cm) £11
SP1629456		Spare platilon liner (2 pack)	16 x 14" (41x36cm) £11
SP1629457		Spare platilon liner (2 pack)	16 x 15" (41x38cm) £11
SP1602031		Spare platilon liner (2 pack)	16 x 16" (41x41cm) £11
SP1602033		Spare platilon liner (2 pack)	16 x 18" (41x46cm) £11
SP1602032		Spare platilon liner (2 pack)	17 x 17" (43x43cm) £11
SP1602034		Spare platilon liner (2 pack)	18 x 16" (46x41cm) £11
SP1629458		Spare platilon liner (2 pack)	18 x 17" (46x43cm) £11
SP1602035		Spare platilon liner (2 pack)	18 x 18" (46x46cm) £11
SP1602036		Spare platilon liner (2 pack)	19 x 17" (48x43cm) £11
SP1602037		Spare platilon liner (2 pack)	20 x 18" (51x46cm) £11
SP1602481		Spare platilon liner (2 pack)	20 x 20" (51x51cm) £11
SP1630454		Spare platilon liner (2 pack)	22 x 18" (56x46cm) £11
SP1630456		Spare platilon liner (2 pack)	22 x 20" (56x51cm) £11
SP1630460		Spare platilon liner (2 pack)	24 x 18" (61x46cm) £11
SP1630462		Spare platilon liner (2 pack)	24 x 20" (61x51cm) £11
<b>Propad Revolve V covers</b>			
SP1629498		Spare sewn blue cover	14 x 14" (36x36cm) £43
SP1629499		Spare sewn blue cover	14 x 15" (36x38cm) £43
SP1629500		Spare sewn blue cover	14 x 16" (36x41cm) £43
SP1629501		Spare sewn blue cover	15 x 14" (38x36cm) £43
SP1629502		Spare sewn blue cover	15 x 15" (38x38cm) £43
SP1629503		Spare sewn blue cover	15 x 16" (38x41cm) £43
SP1629504		Spare sewn blue cover	16 x 14" (41x36cm) £43
SP1629505		Spare sewn blue cover	16 x 15" (41x38cm) £43
SP1602619		Spare sewn blue cover	16 x 16" (41x41cm) £43
SP1602622		Spare sewn blue cover	16 x 18" (41x46cm) £43
SP1602621		Spare sewn blue cover	17 x 17" (43x43cm) £43
SP1602623		Spare sewn blue cover	18 x 16" (46x41cm) £43
SP1629506		Spare sewn blue cover	18 x 17" (46x43cm) £43
SP1602624		Spare sewn blue cover	18 x 18" (46x46cm) £43
SP1602625		Spare sewn blue cover	19 x 17" (48x43cm) £43
SP1602626		Spare sewn blue cover	20 x 18" (51x46cm) £43
SP1602627		Spare sewn blue cover	20 x 20" (51x51cm) £43
SP1630535		Spare sewn blue cover	22 x 18" (56x46cm) £43
SP1630537		Spare sewn blue cover	22 x 20" (56x51cm) £43
SP1630541		Spare sewn blue cover	24 x 18" (61x46cm) £43
SP1630543		Spare sewn blue cover	24 x 20" (61x51cm) £43
SP1629639		Spare sewn black cover	14 x 14" (36x36cm) £43

SP1629640	Spare sewn black cover	14 x 15" (36x38cm)	£43
SP1629641	Spare sewn black cover	14 x 16" (36x41cm)	£43
SP1629642	Spare sewn black cover	15 x 14" (38x36cm)	£43
SP1629643	Spare sewn black cover	15 x 15" (38x38cm)	£43
SP1629644	Spare sewn black cover	15 x 16" (38x41cm)	£43
SP1629645	Spare sewn black cover	16 x 14" (41x36cm)	£43
SP1629646	Spare sewn black cover	16 x 15" (41x38cm)	£43
SP1627588	Spare sewn black cover	16 x 16" (41x41cm)	£43
SP1627590	Spare sewn black cover	16 x 18" (41x46cm)	£43
SP1627589	Spare sewn black cover	17 x 17" (43x43cm)	£43
SP1627591	Spare sewn black cover	18 x 16" (46x41cm)	£43
SP1629647	Spare sewn black cover	18 x 17" (46x43cm)	£43
SP1627592	Spare sewn black cover	18 x 18" (46x46cm)	£43
SP1627593	Spare sewn black cover	19 x 17" (48x43cm)	£43
SP1627594	Spare sewn black cover	20 x 18" (51x46cm)	£43
SP1627595	Spare sewn black cover	20 x 20" (51x51cm)	£43
SP1630633	Spare sewn black cover	22 x 18" (56x46cm)	£43
SP1630634	Spare sewn black cover	22 x 20" (56x51cm)	£43
SP1630635	Spare sewn black cover	24 x 18" (61x46cm)	£43
SP1630636	Spare sewn black cover	24 x 20" (61x51cm)	£43
SP1629582	Spare welded baltic blue cover	14 x 14" (36x36cm)	£59
SP1629583	Spare welded baltic blue cover	14 x 15" (36x38cm)	£59
SP1629584	Spare welded baltic blue cover	14 x 16" (36x41cm)	£59
SP1629585	Spare welded baltic blue cover	15 x 14" (38x36cm)	£59
SP1629586	Spare welded baltic blue cover	15 x 15" (38x38cm)	£59
SP1629587	Spare welded baltic blue cover	15 x 16" (38x41cm)	£59
SP1629588	Spare welded baltic blue cover	16 x 14" (41x36cm)	£59
SP1629589	Spare welded baltic blue cover	16 x 15" (41x38cm)	£59
SP1602192	Spare welded baltic blue cover	16 x 16" (41x41cm)	£59
SP1602248	Spare welded baltic blue cover	16 x 18" (41x46cm)	£59
SP1602193	Spare welded baltic blue cover	17 x 17" (43x43cm)	£59
SP1602267	Spare welded baltic blue cover	18 x 16" (46x41cm)	£59
SP1629590	Spare welded baltic blue cover	18 x 17" (46x43cm)	£59
SP1602268	Spare welded baltic blue cover	18 x 18" (46x46cm)	£59
SP1602286	Spare welded baltic blue cover	19 x 17" (48x43cm)	£59
SP1602317	Spare welded baltic blue cover	20 x 18" (51x46cm)	£59
SP1602617	Spare welded baltic blue cover	20 x 20" (51x51cm)	£59
SP1630576	Spare welded baltic blue cover	22 x 18" (56x46cm)	£59
SP1630578	Spare welded baltic blue cover	22 x 20" (56x51cm)	£59
SP1630582	Spare welded baltic blue cover	24 x 18" (61x46cm)	£59
SP1630584	Spare welded baltic blue cover	24 x 20" (61x51cm)	£59
<b>Propad Revolve Si covers</b>			
SP1629470	Spare sewn blue cover	14 x 14" (36x36cm)	£43
SP1629471	Spare sewn blue cover	14 x 15" (36x38cm)	£43
SP1629472	Spare sewn blue cover	14 x 16" (36x41cm)	£43
SP1629473	Spare sewn blue cover	15 x 14" (38x36cm)	£43
SP1629474	Spare sewn blue cover	15 x 15" (38x38cm)	£43
SP1629475	Spare sewn blue cover	15 x 16" (38x41cm)	£43
SP1629476	Spare sewn blue cover	16 x 14" (41x36cm)	£43
SP1629477	Spare sewn blue cover	16 x 15" (41x38cm)	£43
SP1602059	Spare sewn blue cover	16 x 16" (41x41cm)	£43
SP1602060	Spare sewn blue cover	16 x 18" (41x46cm)	£43
SP1602061	Spare sewn blue cover	17 x 17" (43x43cm)	£43
SP1602062	Spare sewn blue cover	18 x 16" (46x41cm)	£43
SP1629478	Spare sewn blue cover	18 x 17" (46x43cm)	£43
SP1602063	Spare sewn blue cover	18 x 18" (46x46cm)	£43
SP1602064	Spare sewn blue cover	19 x 17" (48x43cm)	£43
SP1602065	Spare sewn blue cover	20 x 18" (51x46cm)	£43
SP1602475	Spare sewn blue cover	20 x 20" (51x51cm)	£43
SP1630515	Spare sewn blue cover	22 x 18" (56x46cm)	£43
SP1630517	Spare sewn blue cover	22 x 20" (56x51cm)	£43
SP1630521	Spare sewn blue cover	24 x 18" (61x46cm)	£43
SP1630523	Spare sewn blue cover	24 x 20" (61x51cm)	£43
SP1629609	Spare sewn black cover	14 x 14" (36x36cm)	£43
SP1629610	Spare sewn black cover	14 x 15" (36x38cm)	£43
SP1629611	Spare sewn black cover	14 x 16" (36x41cm)	£43
SP1629612	Spare sewn black cover	15 x 14" (38x36cm)	£43

SP1629613	Spare sewn black cover	15 x 15" (38x38cm)	£43
SP1629614	Spare sewn black cover	15 x 16" (38x41cm)	£43
SP1629615	Spare sewn black cover	16 x 14" (41x36cm)	£43
SP1629616	Spare sewn black cover	16 x 15" (41x38cm)	£43
SP1627580	Spare sewn black cover	16 x 16" (41x41cm)	£43
SP1627581	Spare sewn black cover	16 x 18" (41x46cm)	£43
SP1627582	Spare sewn black cover	17 x 17" (43x43cm)	£43
SP1627583	Spare sewn black cover	18 x 16" (46x41cm)	£43
SP1629617	Spare sewn black cover	18 x 17" (46x43cm)	£43
SP1627584	Spare sewn black cover	18 x 18" (46x46cm)	£43
SP1627585	Spare sewn black cover	19 x 17" (48x43cm)	£43
SP1627586	Spare sewn black cover	20 x 18" (51x46cm)	£43
SP1627587	Spare sewn black cover	20 x 20" (51x51cm)	£43
SP1630629	Spare sewn black cover	22 x 18" (56x46cm)	£43
SP1630630	Spare sewn black cover	22 x 20" (56x51cm)	£43
SP1630631	Spare sewn black cover	24 x 18" (61x46cm)	£43
SP1630632	Spare sewn black cover	24 x 20" (61x51cm)	£43
SP1629553	Spare welded baltic blue cover	14 x 14" (36x36cm)	£59
SP1629554	Spare welded baltic blue cover	14 x 15" (36x38cm)	£59
SP1629555	Spare welded baltic blue cover	14 x 16" (36x41cm)	£59
SP1629556	Spare welded baltic blue cover	15 x 14" (38x36cm)	£59
SP1629557	Spare welded baltic blue cover	15 x 15" (38x38cm)	£59
SP1629558	Spare welded baltic blue cover	15 x 16" (38x41cm)	£59
SP1629559	Spare welded baltic blue cover	16 x 14" (41x36cm)	£59
SP1629560	Spare welded baltic blue cover	16 x 15" (41x38cm)	£59
SP1602152	Spare welded baltic blue cover	16 x 16" (41x41cm)	£59
SP1602158	Spare welded baltic blue cover	16 x 18" (41x46cm)	£59
SP1602159	Spare welded baltic blue cover	17 x 17" (43x43cm)	£59
SP1602160	Spare welded baltic blue cover	18 x 16" (46x41cm)	£59
SP1629561	Spare welded baltic blue cover	18 x 17" (46x43cm)	£59
SP1602161	Spare welded baltic blue cover	18 x 18" (46x46cm)	£59
SP1602190	Spare welded baltic blue cover	19 x 17" (48x43cm)	£59
SP1602191	Spare welded baltic blue cover	20 x 18" (51x46cm)	£59
SP1602618	Spare welded baltic blue cover	20 x 20" (51x51cm)	£59
SP1630556	Spare welded baltic blue cover	22 x 18" (56x46cm)	£59
SP1630558	Spare welded baltic blue cover	22 x 20" (56x51cm)	£59
SP1630562	Spare welded baltic blue cover	24 x 18" (61x46cm)	£59
SP1630564	Spare welded baltic blue cover	24 x 20" (61x51cm)	£59

**Special Instructions - Extended lead times will apply**

**Name:** \_\_\_\_\_ **Email:** \_\_\_\_\_ **Phone:** \_\_\_\_\_

**Description of special request (please include relevant option code):**







Yes, you can.™

Tel: 01656 776222 Fax: 01656 776220  
Email: ordersuk@invacare.com  
www.invacare.co.uk

<b>Account Name :</b>	<b>Account No :</b>
<b>Address :</b>	<b>Order No :</b>
<b>Tel No:</b>	<b>Order Qty :</b>
<b>Delivery address :</b>	<b>Order Date :</b>

**Matrx Mini PS cushion**  
Retail order form  
Max user weight 68kg

		WIDTH				
		26	28	31	33	36
HEIGHT	cm					
	inch	10	11	12	13	14
	26	10				
	31	12				
	36	14				
41	16					



**Standard Features:**  
Paediatric size wheelchair cushion  
Durable contoured foam  
Waffled ischial relief  
Water resistant and breathable cover with Kidabra print  
Waterfall front edge

Code	X	Description	Price
<b>Mini PS cushion</b>			
1626825		PS cushion with Kidabra print 26W x 26D cm	10x10" £221
1626826		PS cushion with Kidabra print 26W x 31D cm	10x12" £221
1626827		PS cushion with Kidabra print 26W x 36D cm	10x14" £221
1627453		PS cushion with Kidabra print 28W x 31Dcm	11X12" £221
1627454		PS cushion with Kidabra print 28W x 36Dcm	11X14" £221
1627455		PS cushion with Kidabra print 28W x 41Dcm	11X16" £221
1626906		PS cushion with Kidabra print 31W x 31Dcm	12X12" £221
1626907		PS cushion with Kidabra print 31W x 36Dcm	12X14" £221
1626908		PS cushion with Kidabra print 31W x 41Dcm	12X16" £221
1627456		PS cushion with Kidabra print 33W x 31Dcm	13X12" £221
1627457		PS cushion with Kidabra print 33W x 36Dcm	13X14" £221
1627458		PS cushion with Kidabra print 33W x 41Dcm	13X16" £221
1626909		PS cushion with Kidabra print 36W x 31Dcm	14X12" £221
1626910		PS cushion with Kidabra print 36W x 36Dcm	14X14" £221
1626911		PS cushion with Kidabra print 36W x 41Dcm	14X16" £221
<b>Replacement options</b>			
1626828		Spare PS cushion cover with Kidabra print 26W x 26D cm	10x10" £149
1626829		Spare PS cushion cover with Kidabra print 26W x 31D cm	10x12" £149
1626830		Spare PS cushion cover with Kidabra print 26W x 36D cm	10x14" £149
1627459		Spare PS cushion cover with Kidabra print 28W x 31D cm	11X12" £149
1627460		Spare PS cushion cover with Kidabra print 28W x 36D cm	11x14" £149
1627461		Spare PS cushion cover with Kidabra print 28W x 41D cm	11x16" £149
1626912		Spare PS cushion cover with Kidabra print 31W x 31D cm	12x12" £149
1626913		Spare PS cushion cover with Kidabra print 31W x 36D cm	12x14" £149
1626914		Spare PS cushion cover with Kidabra print 31W x 41D cm	21x16" £149
1627462		Spare PS cushion cover with Kidabra print 33W x 31D cm	13x12" £149
1627463		Spare PS cushion cover with Kidabra print 33W x 36D cm	13x14" £149
1627464		Spare PS cushion cover with Kidabra print 33W x 41D cm	13x16" £149
1626916		Spare PS cushion cover with Kidabra print 36W x 31D cm	13x12" £149
1626917		Spare PS cushion cover with Kidabra print 36W x 36D cm	14x14" £149
1627764		Spare PS cushion cover with Kidabra print 36W x 41D cm	14x16" £149
<b>TOTAL PRICE:</b>			

Order No :  
Customer Ref :



**Special Instructions - Please supply the following information:**

**Name:**

**Email:**

**Phone:**

**Description of special request (please include relevant option code):**



Yes, you can.®

Tel: 01656 776222 Fax: 01656 776220  
 Email: ordersuk@invacare.com  
 www.invacare.co.uk

Matrx Flo-Tech Lite cushion  
 April 2020

<b>Customer name:</b>	<b>Account No :</b>
<b>Contact no:</b>	<b>Order No :</b>
<b>Delivery address:</b>	<b>Order Qty :</b>
	<b>Order Date :</b>

**Matrx Flo-tech Lite**  
 Retail order form  
 Maximum User Weight 127kg (20 stone)

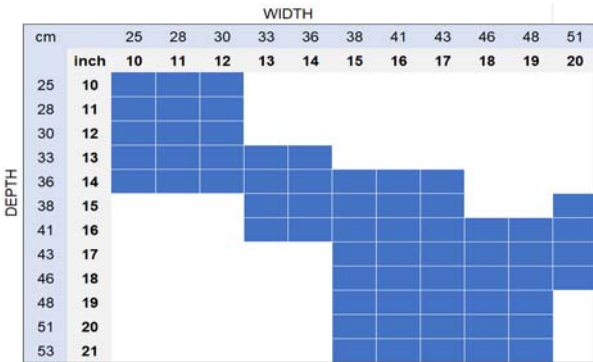

Contoured into sections offering

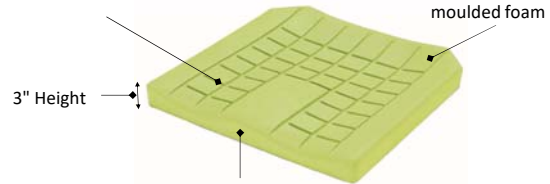

With sizes starting from 10x10" (25 x 25 cm) the Lite cushion is particularly suited to paediatric clients.



**Features**  
 Comfort/ Low Risk  
 3" height  
 Two way stretch vapour permeable cover  
 Accessories available  
 Anti Slip Base with handle  
 3 Year Warranty

**matrx Flo-tech**

Code	X	Description	Price
<b>Matrx Flo-tech Lite</b>			
HFL0002		Complete Cushion	£107
HFL0003		Cover Only	£59
HFL0004		Foam Only	£56
HFL0005		Pack of 3 Replacement Plaiton Liners	£11
<b>Foam Type</b>			
HFL0006		Standard Foam (nc 3, 5)	◆
<b>Base Type</b>			
HFL0007		Flat Base (nc 5)	◆
HFL0008		Sag Infill Base (nc 5)	○
<b>Seat Width</b>			
HFL0009		25cm (10 Inches) (nc 23, 24, 25, 26 ,27, 28, 29, 30)	○
HFL0010		28cm (11 Inches) (nc 23, 24, 25, 26, 27, 28, 29, 30)	○
HFL0011		30cm (12 Inches) (nc 26, 27, 28, 29, 30)	○
HFL0012		33cm (13 Inches) (nc 19, 20, 21, 26, 27, 28, 29, 30)	○
HFL0013		36cm (14 Inches) (nc 19, 20, 21, 26, 27, 28, 29, 30)	○
HFL0014		38cm (15 Inches) (nc 19, 20, 21, 22)	○
HFL0015		41cm (16 inches) (nc 19, 20, 21, 22)	○
HFL0016		43cm (17 Inches) (nc 19, 20, 21, 22)	○

HFL0017	46cm (18 Inches) (nc 19, 20, 21, 22, 23, 24, 25)	○
HFL0018	48cm (19 Inches) (nc 19, 20, 21, 22, 23, 24, 25)	○
HFL0049	51cm (20 Inches) (nc 19, 20, 21, 22, 23, 24, 25)	○
<b>Seat Depth</b>		
HFL0019	25cm (10 Inches)	○
HFL0020	28cm (11 Inches)	○
HFL0021	30cm (12 Inches)	○
HFL0022	33cm (13 Inches)	○
HFL0023	36cm (14 Inches)	○
HFL0024	38cm (15 Inches)	○
HFL0025	41cm (16 Inches)	○
HFL0026	43cm (17 Inches)	○
HFL0027	46cm (18 Inches)	○
HFL0028	48cm (19 Inches)	○
HFL0029	51cm (20 Inches)	○
HFL0030	53cm (21 Inches)	○
<b>Fabric Type</b>		
HFL0031	Standard Coloured Baltic Blue Wipedown (nc 4, 5)	◆
HFL0032	Black Smooth (nc 4, 5)	○
HFL0033	Black Wipedown (nc 4, 5)	○
HFL0047	Black Spacer (nc 4, 5)	○
<b>Cover Branding</b>		
HFL0035	Standard Invacare Branded Cover (nc 4, 5)	◆
<b>Cover Type</b>		
HFL0039	Sewn Cover (nc 4, 5)	◆
HFL0040	High Frequency Welded Cover (nc 4, 5, 8, 32, 33, 47)	○
<b>Liner</b>		
HFL0041	Platilon Liner Covering Moulded Foam (nc 3, 4, 5)	○
HFL0042	No Platilon Liner Required	○
<b>Velcro</b>		
HFL0043	Velcro Pieces Sewn On Cover Base (nc 4, 5)	£26
HFL0044	No Velcro Required	○
<b>Homebrand Logo</b>		
HFL0045	Homebrand Logo (nc 4, 5, 32, 33) Order qty over 50 units at one time. One off set up charge on first order	£26
HFL0046	No Homebrand Logo Required	○
		<b>Total Price</b>
		<b>Quantity</b>
<b>Accessories</b>		
1494494	Rigidiser W14" x D16"	£37
1487165	Rigidiser W16" x D16"	£37
1494495	Rigidiser W16" x D18"	£37
1494496	Rigidiser W16" x D20"	£72
1494497	Rigidiser W18" x D16"	£37
1494498	Rigidiser W18" x D18"	£37
1494499	Rigidiser W18" x D20"	£72
1494500	Rigidiser W20" x D16"	£37
1494501	Rigidiser W20" x D18"	£37
1494502	Rigidiser W20" x D20"	£72
1494503	Rigidiser W22" x D18"	£72
1494504	Rigidiser W22" x D20"	£72
		<b>Total Price</b>
<b>Office use only: Process cushion on configurator and accessories as line items.</b>		



Tel: 01656 776222 Fax: 01656 776220  
Email: ordersuk@invacare.com  
www.invacare.co.uk

Flo-tech Lite Visco Soft cushion  
April 2020

<b>Customer name:</b>	<b>Account No :</b>
<b>Contact no:</b>	<b>Order No :</b>
<b>Delivery address:</b>	<b>Order Qty :</b>
	<b>Order Date :</b>

**Matrx Flo-tech Lite Visco Soft**  
Retail order form  
Maximum User Weight 32kg (5 stone)

		WIDTH					
		cm	25	28	30	33	36
		inch	10	11	12	13	14
DEPTH	25	10					
	28	11					
	30	12					
	33	13					
	36	14					
	41	16					

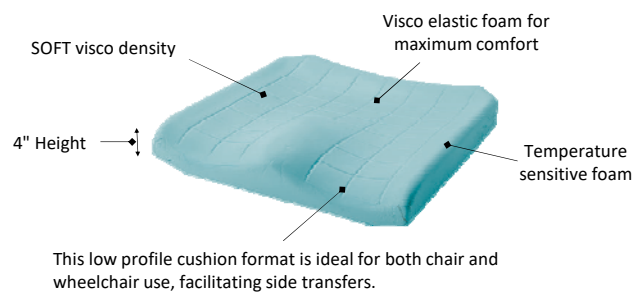

**Features**  
At Risk/Increased Vulnerability  
4" height  
Two way stretch vapour permeable cover  
Accessories available  
Anti Slip Base with handle  
3 Year Warranty



Code	X	Description	Price
<b>Flo-tech Lite Visco Soft</b>			
HLS0002		Complete Cushion	£114
HLS0003		Cover Only	£59
HLS0004		Foam Only	£88
HLS0005		Pack of 3 Replacement Platilon Liners	£11
<b>Foam Type</b>			
HLS0006		Soft Visco Foam (nc 5)	◆
<b>Base Type</b>			
HLS0007		Flat Base (nc 5)	○
HLS0008		Sag Infill Base (nc 5)	◆
<b>Seat Width</b>			
HLS0009		25cm (10 Inches) (nc 18, 19, 20)	○
HLS0010		28cm (11 Inches) (nc 18, 19, 20)	○
HLS0011		30cm (12 Inches)	○
HLS0012		33cm (13 Inches) (nc 14, 15, 16)	○
HLS0013		36cm (14 Inches) (nc 14, 15, 16)	○
<b>Seat Depth</b>			
HLS0014		25cm (10 Inches)	○

HLS0015	28cm (11 Inches)	○
HLS0016	30cm (12 Inches)	○
HLS0017	33cm (13 Inches)	○
HLS0018	36cm (14 Inches)	○
HLS0019	38cm (15 Inches)	○
HLS0020	41cm (16 Inches)	○
<b>Fabric Type</b>		
HLS0021	Standard Coloured Baltic Blue Wipedown (nc 4, 5)	◆
HLS0022	Black Smooth Cover (nc 4, 5)	○
HLS0023	Black Wipedown Cover (nc 4, 5)	○
HLS0037	Black Spacer (nc 4, 5)	○
<b>Cover Branding</b>		
HLS0025	Standard Invacare Branded Cover (nc 4, 5)	◆
<b>Cover Type</b>		
HLS0029	Sewn Cover (nc 4, 5)	◆
HLS0030	High Frequency Welded Cover (nc 4, 5, 8, 22, 23, 37)	○
<b>Liner</b>		
HLS0031	Platilon Liner Covering Moulded Foam (nc 3, 5)	○
HLS0032	No Platilon Liner Required	○
<b>Velcro</b>		
HLS0033	Velcro Pieces Sewn On Cover Base (nc 4, 5)	£26
HLS0034	No Velcro Required	○
<b>Homebrand Logo</b>		
HLS0035	Homebrand Logo (nc 4, 5, 22, 23, 24) Order qty over 50 units at one time. One off set up charge on first order	£26
HLS0036	No Homebrand Logo Required	○
<b>Total Price</b>		
<b>Quantity</b>		
<b>Accessories</b>		
1494494	Rigidiser W14" x D16"	£37
1487165	Rigidiser W16" x D16"	£37
1494495	Rigidiser W16" x D18"	£37
1494496	Rigidiser W16" x D20"	£72
1494497	Rigidiser W18" x D16"	£37
1494498	Rigidiser W18" x D18"	£37
1494499	Rigidiser W18" x D20"	£72
1494500	Rigidiser W20" x D16"	£37
1494501	Rigidiser W20" x D18"	£37
1494502	Rigidiser W20" x D20"	£72
1494503	Rigidiser W22" x D18"	£72
1494504	Rigidiser W22" x D20"	£72
<b>Office use only: Process cushion on configurator and accessories as line items.</b>		

Tel: 01656 776222 Fax: 01656 776220  
Email: ordersuk@invacare.com  
www.invacare.co.uk

Flo-tech Lite Visco Medium cushion  
**April 2020**

<b>Customer name:</b>	<b>Account No :</b>
<b>Contact no:</b>	<b>Order No :</b>
<b>Delivery address:</b>	<b>Order Qty :</b>
	<b>Order Date :</b>

**Matrx Flo-tech Lite Visco Medium**  
Retail order form  
Maximum User Weight 51kg (8 stone)

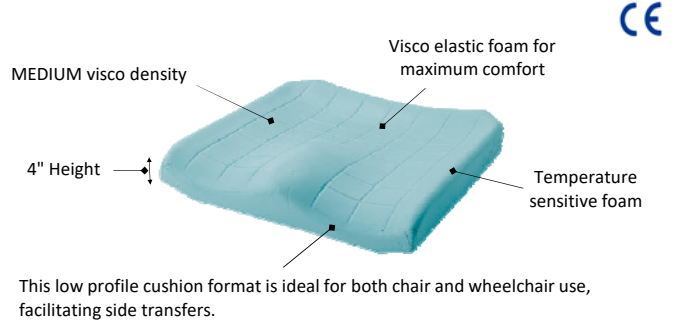
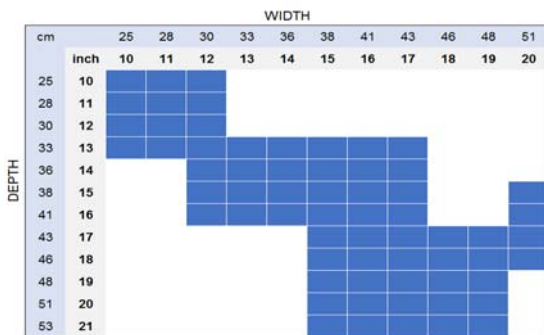

**Features**

- At Risk/Increased Vulnerability
- 4" height
- Two way stretch vapour permeable cover
- Accessories available
- Anti Slip Base with handle
- 3 Year Warranty



Code	X	Description	Price
<b>Flo-tech Lite Visco Medium</b>			
HLM0002		Complete Cushion	£114
HLM0003		Cover Only	£59
HLM0004		Foam Only	£88
HLM0005		Pack of 3 Replacement Platilon Liners	£11
<b>Foam Type</b>			
HLM0006		Medium Visco Foam (nc 5)	◆
<b>Base Type</b>			
HLM0007		Flat Base (nc 5)	○
HLM0008		Sag Infill Base (nc 5)	◆
<b>Seat Width</b>			
HLM0009		25cm (10 Inches) (nc 23, 24, 25, 26, 27, 28, 29, 30)	○
HLM0010		28cm (11 Inches) (nc 23, 24, 25, 26, 27, 28, 29, 30)	○
HLM0011		30cm (12 Inches) (nc 26, 27, 28, 29, 30)	○
HLM0012		33cm (13 Inches) (nc 19, 20, 21, 26, 27, 28, 29, 30)	○
HLM0013		36cm (14 Inches) (nc 19, 20, 21, 26, 27, 28, 29, 30)	○
HLM0014		38cm (15 Inches) (nc 19, 20, 21, 22)	○
HLM0015		41cm (16 Inches) (nc 19, 20, 21, 22)	○
HLM0016		43cm (17 Inches) (nc 19, 20, 21, 22)	○
HLM0017		46cm (18 Inches) (nc 19, 20, 21, 22, 23, 24, 25)	○

HLM0018	48cm (19 Inches) (nc 19, 20, 21, 22, 23, 24, 25)	○
HLM0049	51cm (20 inches) (nc 19,20,21,22,23,28,29,30)	○
<b>Seat Depth</b>		
HLM0019	25cm (10 Inches)	○
HLM0020	28cm (11 Inches)	○
HLM0021	30cm (12 Inches)	○
HLM0022	33cm (13 Inches)	○
HLM0023	36cm (14 Inches)	○
HLM0024	38cm (15 Inches)	○
HLM0025	41cm (16 Inches)	○
HLM0026	43cm (17 Inches)	○
HLM0027	46cm (18 Inches)	○
HLM0028	48cm (19 Inches)	○
HLM0029	51cm (20 Inches)	○
HLM0030	53cm (21 Inches)	○
<b>Fabric Type</b>		
HLM0031	Standard Coloured Baltic Blue Wipedown (nc 4, 5)	◆
HLM0032	Black Smooth Cover (nc 4, 5)	○
HLM0033	Black Wipedown Cover (nc 4, 5)	○
HLM0047	Black Spacer (nc 4, 5)	○
<b>Cover Branding</b>		
HLM0035	Standard Invacare Branded Cover (nc 4, 5)	◆
<b>Cover Type</b>		
HLM0039	Sewn Cover (nc 4, 5)	◆
HLM0040	High Frequency Welded Cover (nc 4, 5, 8, 32, 33, 47)	○
<b>Liner</b>		
HLM0041	Platilon Liner Covering Moulded Foam (nc 3, 5)	○
HLM0042	No Platilon Liner Required	○
<b>Velcro</b>		
HLM0043	Velcro Pieces Sewn On Cover Base (nc 4, 5)	£26
HLM0044	No Velcro Required	○
<b>Homebrand Logo</b>		
HLM0045	Homebrand Logo (nc 4, 5, 32, 33, 34, 36, 37) Order qty over 50 units at one time. One off set up charge on first order	£26
HLM0046	No Homebrand Logo Required	○
		<b>Total Price</b>
		<b>Quantity</b>
<b>Accessories</b>		
1494494	Rigidiser W14" x D16"	£37
1487165	Rigidiser W16" x D16"	£37
1494495	Rigidiser W16" x D18"	£37
1494496	Rigidiser W16" x D20"	£72
1494497	Rigidiser W18" x D16"	£37
1494498	Rigidiser W18" x D18"	£37
1494499	Rigidiser W18" x D20"	£72
1494500	Rigidiser W20" x D16"	£37
1494501	Rigidiser W20" x D18"	£37
1494502	Rigidiser W20" x D20"	£72
1494503	Rigidiser W22" x D18"	£72
1494504	Rigidiser W22" x D20"	£72
<b>Office use only: Process cushion on configurator and accessories as line items.</b>		

Tel: 01656 776222 Fax: 01656 776220  
Email: ordersuk@invacare.com  
www.invacare.co.uk

<b>Account Name :</b>	<b>Account No :</b>
<b>Address :</b>	<b>Order No :</b>
<b>Tel No:</b>	<b>Order Qty :</b>
<b>Delivery address :</b>	<b>Order Date :</b>

**Matrx Flo-tech Lite Visco Firm**  
Retail order form  
Maximum User Weight 101kg (16 stone)

		WIDTH						
		38	41	43	46	48	51	
DEPTH	inch	15	16	17	18	19	20	
	36	14	■	■	■	■		
	38	15	■	■	■	■		■
	41	16	■	■	■	■		■
	43	17	■	■	■	■	■	■
	46	18	■	■	■	■	■	■
	48	19	■	■	■	■	■	■
	51	20	■	■	■	■	■	■
53	21							

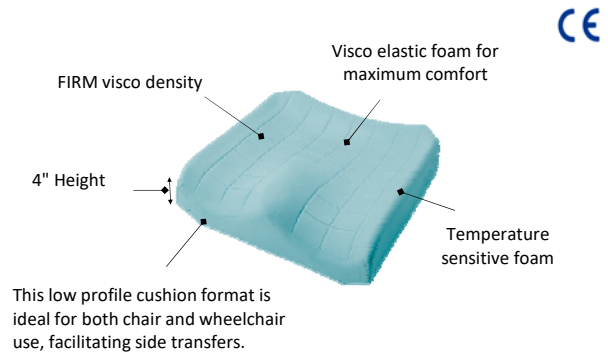

**Features**  
At Risk/Increased Vulnerability  
4" height  
3 Year Warranty  
Two way stretch vapour permeable cover  
Accessories available  
Anti Slip Base with handle



Code	X	Description	Price
<b>Flo-tech Lite Visco Firm</b>			
HLF0002		Complete Cushion	£114
HLF0003		Cover Only	£59
HLF0004		Foam Only	£88
HLF0005		Pack of 3 Replacement Platilon Liners	£11
<b>Foam Type</b>			
HLF0006		Firm Visco Foam (nc 5)	◆
<b>Base Type</b>			
HLF0007		Flat Base (nc 5)	○
HLF0008		Sag Infill Base (nc 5)	◆
<b>Seat Width</b>			
HLF0009		38cm (15 Inches)	○
HLF0010		41cm (16 Inches)	○
HLF0011		43cm (17 Inches)	○
HLF0012		46cm (18 Inches) (nc 14, 15, 16)	○
HLF0013		48cm (19 Inches) (nc 14, 15, 16)	○
HLF0040		51cm (20 inches) (nc 14, 19, 20, 21)	○

<b>Seat Depth</b>			
HLF0014		36cm (14 Inches)	○
HLF0015		38cm (15 Inches)	○
HLF0016		41cm (16 Inches)	○
HLF0017		43cm (17 Inches)	○
HLF0018		46cm (18 Inches)	○
HLF0019		48cm (19 Inches)	○
HLF0020		51cm (20 Inches)	○
HLF0021		53cm (21 Inches)	○
<b>Fabric Type</b>			
HLF0022		Standard Coloured Baltic Blue Wipedown (nc 4, 5)	◆
HLF0023		Black Smooth Cover (nc 4, 5)	○
HLF0024		Black Wipedown Cover (nc 4, 5)	○
HLF0038		Black Spacer Cover (nc 4, 5)	○
<b>Cover Branding</b>			
HLF0026		Standard Invacare Branded Cover (nc 4, 5)	◆
<b>Cover Type</b>			
HLF0030		Sewn Cover (nc 4, 5)	◆
HLF0031		High Frequency Welded Cover (nc 4, 5, 8, 23, 24, 38)	○
<b>Liner</b>			
HLF0032		Platilon Liner Covering Moulded Foam (nc 3, 5)	○
HLF0033		No Platilon Liner Required	○
<b>Velcro</b>			
HLF0034		Velcro Pieces Sewn On Cover Base (nc 4, 5)	£26
HLF0035		No Velcro Required	○
<b>Homebrand Logo</b>			
HLF0036		Homebrand Logo (nc 4, 5, 23, 24) Order qty over 50 units at one time. One off set up charge on first order	£26
HLF0037		No Homebrand Logo Required	○
			<b>Total Price</b>
			<b>Quantity</b>
<b>Accessories</b>			
1494494		Rigidiser W14" x D16"	£37
1487165		Rigidiser W16" x D16"	£37
1494495		Rigidiser W16" x D18"	£37
1494496		Rigidiser W16" x D20"	£72
1494497		Rigidiser W18" x D16"	£37
1494498		Rigidiser W18" x D18"	£37
1494499		Rigidiser W18" x D20"	£72
1494500		Rigidiser W20" x D16"	£37
1494501		Rigidiser W20" x D18"	£37
1494502		Rigidiser W20" x D20"	£72
1494503		Rigidiser W22" x D18"	£72
1494504		Rigidiser W22" x D20"	£72
			<b>Total Price</b>
<b>Office use only: Process cushion on configurator and accessories as line items.</b>			

Tel: 01656 776222 Fax: 01656 776220  
Email: ordersuk@invacare.com  
www.invacare.co.uk

<b>Customer name:</b>	<b>Account No :</b>
<b>Contact no:</b>	<b>Order No :</b>
<b>Delivery address:</b>	<b>Order Qty :</b>
	<b>Order Date :</b>

**Matrix Flo-tech Contour**  
Retail order form  
Maximum User Weight 191kg (30 stone)

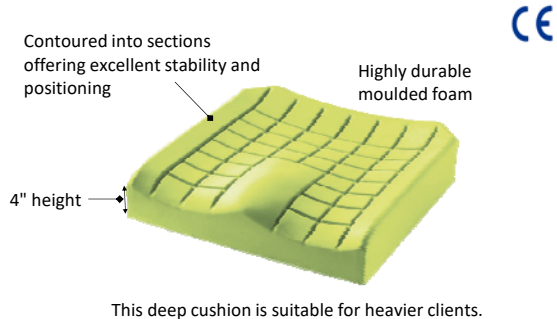
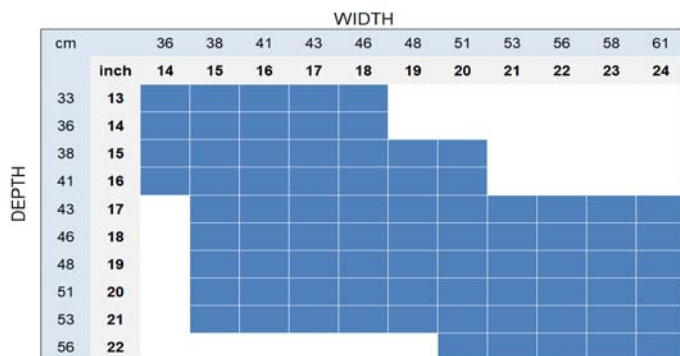

**Features**

- At Risk/Increased Vulnerability
- 4" height
- Two way stretch vapour permeable cover
- Accessories available
- Anti Slip Base with handle
- 3 Year Warranty



Code	X	Description	Price
<b>Flo-tech Contour</b>			
HFC0002		Complete Cushion	£146
HFC0003		Cover Only	£59
HFC0004		Foam Only	£88
HFC0005		Pack of 3 Replacement Platilon Liners	£11
<b>Foam Type</b>			
HFC0006		Standard Foam (nc 3, 5)	◆
<b>Base Type</b>			
HFC0007		Flat Base (nc 5)	◆
HFC0008		Sag Infill Base (nc 5)	○
<b>Seat Width</b>			
HFC0009		36cm (14 Inches) (nc 24, 25, 26, 27, 28, 29)	○
HFC0010		38cm (15 Inches) (nc 29)	○
HFC0011		41cm (16 Inches) (nc 29)	○
HFC0012		43cm (17 Inches) (nc 29)	○
HFC0013		46cm (18 Inches) (nc 29)	○
HFC0014		48cm (19 Inches) (nc 20, 21, 29)	○
HFC0015		51cm (20 Inches) (nc 20, 21)	○

HFC0016	53cm (21 Inches) (nc 20, 21,22, 23)	○
HFC0017	55cm (22 Inches) (nc 20, 21,22, 23)	○
HFC0018	58cm (23 Inches) (nc 20, 21,22, 23)	○
HFC0019	60cm (24 Inches) (nc 20, 21,22, 23)	○
<b>Seat Depth</b>		
HFC0020	33cm (13 Inches)	○
HFC0021	36cm (14 Inches)	○
HFC0022	38cm (15 Inches)	○
HFC0023	41cm (16 Inches)	○
HFC0024	43cm (17 Inches)	○
HFC0025	46cm (18 Inches)	○
HFC0026	48cm (19 Inches)	○
HFC0027	51cm (20 Inches)	○
HFC0028	53cm (21 Inches)	○
HFC0029	55cm (22 Inches)	○
<b>Fabric Type</b>		
HFC0030	Standard Coloured Baltic Blue Wipedown (nc 4, 5)	◆
HFC0031	Black Smooth Cover (nc 4, 5)	○
HFC0032	Black Wipedown Cover (nc 4, 5)	○
HFC0046	Black Spacer (nc 4, 5)	○
<b>Cover Branding</b>		
HFC0034	Standard Invacare Branded Cover (nc 4, 5)	◆
<b>Cover Type</b>		
HFC0038	Sewn Cover (nc 4, 5)	◆
HFC0039	High Frequency Welded Cover (nc 4, 5, 8, 31, 32, 46)	○
<b>Liner</b>		
HFC0040	Platilon Liner Covering Moulded Foam (nc 3, 4, 5)	○
HFC0041	No Platilon Liner Required	○
<b>Velcro</b>		
HFC0042	Velcro Pieces Sewn On Cover Base (nc 4, 5)	£26
HFC0043	No Velcro Required	○
<b>Homebrand Logo</b>		
HFC0044	Homebrand Logo (nc 4, 5, 31, 32, 33, 35, 36) Order qty over 50 units at one time. One off set up charge on first order	£26
HFC0045	No Homebrand/Trust Logo Required	○
		<b>Total Price</b>
		<b>Quantity</b>
<b>Accessories</b>		
1494494	Rigidiser W14" x D16"	£37
1487165	Rigidiser W16" x D16"	£37
1494495	Rigidiser W16" x D18"	£37
1494496	Rigidiser W16" x D20"	£72
1494497	Rigidiser W18" x D16"	£37
1494498	Rigidiser W18" x D18"	£37
1494499	Rigidiser W18" x D20"	£72
1494500	Rigidiser W20" x D16"	£37
1494501	Rigidiser W20" x D18"	£37
1494502	Rigidiser W20" x D20"	£72
1494503	Rigidiser W22" x D18"	£72
1494504	Rigidiser W22" x D20"	£72
		<b>Total Price</b>
<b>Office use only: Process cushion on configurator and accessories as line items.</b>		





Yes, you can.®

Tel: 01656 776222 Fax: 01656 776220  
 Email: ordersuk@invacare.com  
 www.invacare.co.uk

Flo-tech Contour Lo-Back cushion  
 April 2020

<b>Customer name:</b>	<b>Account No :</b>
<b>Contact no:</b>	<b>Order No :</b>
<b>Delivery address:</b>	<b>Order Qty :</b>
	<b>Order Date :</b>

**Matrx Flo-tech Contour Lo-Back**  
 Retail order form  
 Maximum User Weight 152kg (24 stone)

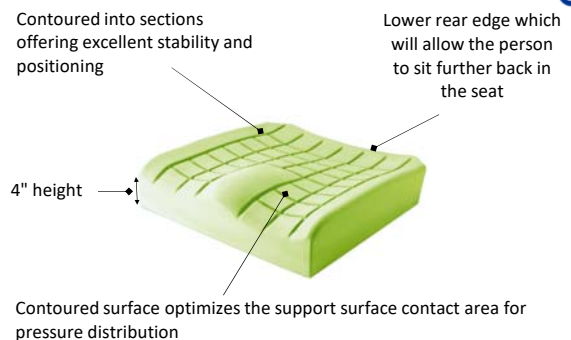
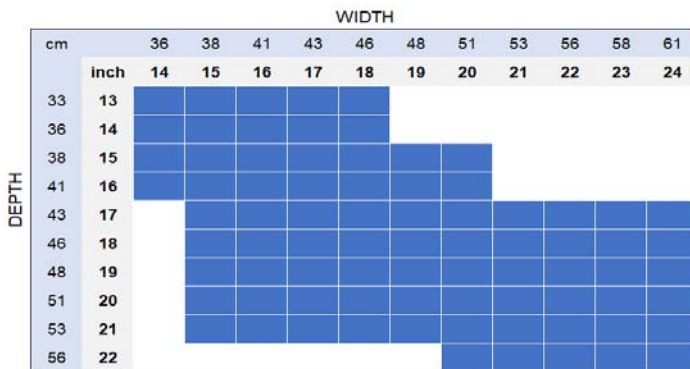

**Features**  
 At Risk/Increased Vulnerability  
 Tapered front to back 4" to 3"  
 Two way stretch vapour permeable cover  
 Accessories available  
 Anti Slip Base with handle  
 3 Year Warranty





Code	X	Description	Price
<b>Flo-tech Contour Lo Back</b>			
HCL0002		Complete Cushion	£147
HCL0003		Cover Only	£59
HCL0004		Foam Only	£98
HCL0005		Pack of 3 Replacement Platilon Liners	£11
<b>Foam Type</b>			
HCL0006		Standard Foam (nc 3, 5)	◆
<b>Base Type</b>			
HCL0007		Flat Base (nc 5)	◆
<b>Seat Width</b>			
HCL0008		36cm (14 Inches) (nc 23, 24, 25, 26, 27, 28)	○
HCL0009		38cm (15 Inches) (nc 28)	○
HCL0010		41cm (16 Inches) (nc 28)	○
HCL0011		43cm (17 Inches) (nc 28)	○
HCL0012		46cm (18 Inches) (nc 28)	○
HCL0013		48cm (19 Inches) (nc 19, 20, 28)	○
HCL0014		51cm (20 Inches) (nc 19, 20)	○

HCL0015	53cm (21 Inches) (nc 19, 20, 21, 22)	○
HCL0016	55cm (22 Inches) (nc 19, 20, 21, 22)	○
HCL0017	58cm (23 Inches) (nc 19, 20, 21, 22)	○
HCL0018	60cm (24 Inches) (nc 19, 20, 21, 22)	○
<b>Seat Depth</b>		
HCL0019	33cm (13 Inches)	○
HCL0020	36cm (14 Inches)	○
HCL0021	38cm (15 Inches)	○
HCL0022	41cm (16 Inches)	○
HCL0023	43cm (17 Inches)	○
HCL0024	46cm (18 Inches)	○
HCL0025	48cm (19 Inches)	○
HCL0026	51cm (20 Inches)	○
HCL0027	53cm (21 Inches)	○
HCL0028	55cm (22 Inches)	○
<b>Fabric Type</b>		
HCL0029	Black Smooth (nc 4, 5)	◆
HCL0038	Black Spacer (nc 4, 5)	○
HCL0039	Black Wipedown (nc 4, 5)	○
<b>Cover Branding</b>		
HCL0030	Standard Invacare Branded Cover (nc 4, 5)	◆
<b>Liner</b>		
HCL0034	Platilon Liner Covering Moulded Foam (nc 3, 4, 5)	○
HCL0035	No Platilon Liner Required	○
<b>Velcro</b>		
HCL0036	Velcro Pieces Sewn On Cover Base (nc 4, 5)	£26
HCL0037	No Velcro Required	○
		<b>Total Price</b>
		<b>Quantity</b>
<b>Accessories</b>		
1494494	Rigidiser W14" x D16"	£37
1487165	Rigidiser W16" x D16"	£37
1494495	Rigidiser W16" x D18"	£37
1494496	Rigidiser W16" x D20"	£72
1494497	Rigidiser W18" x D16"	£37
1494498	Rigidiser W18" x D18"	£37
1494499	Rigidiser W18" x D20"	£72
1494500	Rigidiser W20" x D16"	£37
1494501	Rigidiser W20" x D18"	£37
1494502	Rigidiser W20" x D20"	£72
1494503	Rigidiser W22" x D18"	£72
1494504	Rigidiser W22" x D20"	£72
<b>Office use only: Process cushion on configurator and accessories as line items.</b>		



Yes, you can.

Tel: 01656 776222 Fax: 01656 776220  
 Email: ordersuk@invacare.com  
 www.invacare.co.uk

RETAIL PRESCRIPTION FORM

Flo-tech Contour Low Profile cushion  
 April 2020

<b>Account Name :</b>	<b>Account No :</b>
<b>Address :</b>	<b>Order No :</b>
<b>Tel No:</b>	<b>Order Qty :</b>
<b>Delivery address :</b>	<b>Order Date :</b>

**Matrx Flo-tech Contour Low Profile**  
 Retail order form  
 Maximum User Weight 127kg (20 stone)

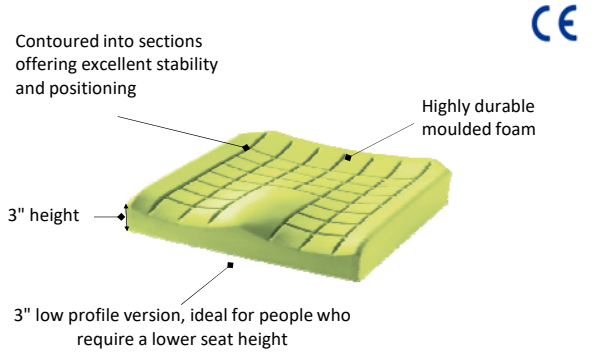
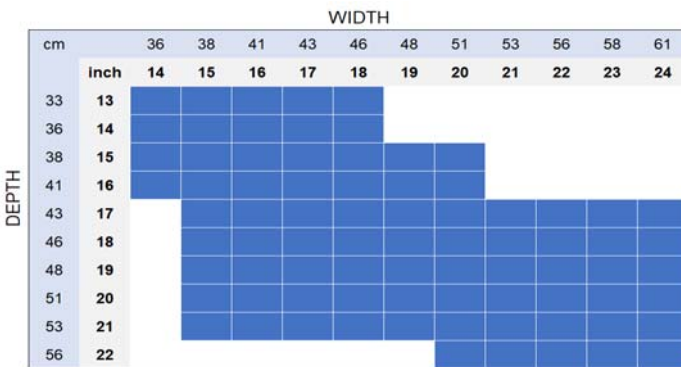

**Features**  
 Comfort/ Low Risk  
 3" height  
 Two way stretch vapour permeable cover Accessories available  
 Anti Slip Base  
 3 Year Warranty

Code	X	Description	Price
<b>Flo-tech Contour Low Profile</b>			
HLC0002		Complete Cushion	£114
HLC0003		Cover Only	£59
HLC0004		Foam Only	£56
HLC0005		Pack of 3 Replacement Platilon Liners	£11
<b>Foam Type</b>			
HLC0006		Standard Foam (nc 3, 5)	◆
<b>Base Type</b>			
HLC0007		Flat Base (nc 5)	◆
HLC0008		Sag Infill Base (nc 5)	○
<b>Seat Width</b>			
HLC0009		36cm (14 Inches) (nc 24, 25, 26, 27, 28, 29)	○
HLC0010		38cm (15 Inches) (nc 29)	○
HLC0011		41cm (16 Inches) (nc 29)	○
HLC0012		43cm (17 Inches) (nc 29)	○
HLC0013		46cm (18 Inches) (nc 29)	○
HLC0014		48cm (19 Inches) (nc 20, 21, 29)	○
HLC0015		51cm (20 Inches) (nc 20, 21)	○

HLC0016	53cm (21 Inches) (nc 20, 21,22, 23)	○
HLC0017	55cm (22 Inches) (nc 20, 21,22, 23)	○
HLC0018	58cm (23 Inches) (nc 20, 21,22, 23)	○
HLC0019	60cm (24 Inches) (nc 20, 21,22, 23)	○
<b>Seat Depth</b>		
HLC0020	33cm (13 Inches)	○
HLC0021	36cm (14 Inches)	○
HLC0022	38cm (15 Inches)	○
HLC0023	41cm (16 Inches)	○
HLC0024	43cm (17 Inches)	○
HLC0025	46cm (18 Inches)	○
HLC0026	48cm (19 Inches)	○
HLC0027	51cm (20 Inches)	○
HLC0028	53cm (21 Inches)	○
HLC0029	55cm (22 Inches)	○
<b>Fabric Type</b>		
HLC0030	Standard Coloured Baltic Blue Wipedown (nc 4, 5)	◆
HLC0031	Black Smooth Cover (nc 4, 5)	○
HLC0032	Black Wipedown Cover (nc 4, 5)	○
HLC0046	Black Spacer (nc 4, 5)	○
<b>Cover Branding</b>		
HLC0034	Standard Invacare Branded Cover (nc 4, 5)	◆
<b>Cover Type</b>		
HLC0038	Sewn Cover (nc 4, 5)	◆
HLC0039	High Frequency Welded Cover (nc 4, 5, 8, 31, 32, 33)	○
<b>Liner</b>		
HLC0040	Platilon Liner Covering Moulded Foam (nc 3, 4, 5)	○
HLC0041	No Platilon Liner Required	○
<b>Velcro</b>		
HLC0042	Velcro Pieces Sewn On Cover Base (nc 4, 5)	£26
HLC0043	No Velcro Required	○
<b>Homebrand Logo</b>		
HLC0044	Homebrand Logo (nc 4, 5, 31, 32, 33, 35, 36) Order qty over 50 units at one time. One off set up charge on first order	£26
HLC0045	No Homebrand Logo Required	○
		<b>Total Price</b>
		<b>Quantity</b>
<b>Accessories</b>		
1494494	Rigidiser W14" x D16"	£37
1487165	Rigidiser W16" x D16"	£37
1494495	Rigidiser W16" x D18"	£37
1494496	Rigidiser W16" x D20"	£72
1494497	Rigidiser W18" x D16"	£37
1494498	Rigidiser W18" x D18"	£37
1494499	Rigidiser W18" x D20"	£72
1494500	Rigidiser W20" x D16"	£37
1494501	Rigidiser W20" x D18"	£37
1494502	Rigidiser W20" x D20"	£72
1494503	Rigidiser W22" x D18"	£72
1494504	Rigidiser W22" x D20"	£72
		<b>Total Price</b>
<b>Office use only: Process cushion on configurator and accessories as line items.</b>		

Tel: 01656 776222 Fax: 01656 776220  
Email: ordersuk@invacare.com  
www.invacare.co.uk

Flo-tech Contour Visco Soft cushion  
**April 2020**

<b>Customer name:</b>	<b>Account No :</b>
<b>Contact no:</b>	<b>Order No :</b>
<b>Delivery address:</b>	<b>Order Qty :</b>
	<b>Order Date :</b>

**Matrx Flo-Tech Contour Visco Soft**  
Retail order form  
Maximum User Weight 51kg (8 stone)

		WIDTH			
		36	38	41	43
DEPTH	cm				
	inch	14	15	16	17
	33	13			
	36	14			
	38	15			
	41	16			
43	17				

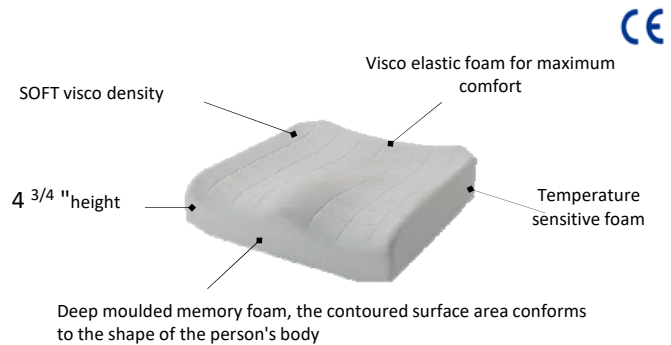

**Features**  
High Risk/Elevated Risk  
4 3/4" height  
Two way stretch vapour permeable cover  
Accessories available  
Anti Slip Base with handle  
3 Year Warranty





Code	X	Description	Price
<b>Flo-tech Contour Visco - Soft</b>			
HVS0002		Complete Cushion	£150
HVS0003		Cover Only	£59
HVS0004		Foam Only	£99
HVS0005		Pack of 3 Replacement Plaiton Liners	£11
<b>Foam Type</b>			
HVS0006		Soft Visco Foam (nc 3, 5)	◆
<b>Base Type</b>			
HVS0007		Flat Base (nc 5)	○
HVS0008		Sag Infill Base (nc 5)	◆
<b>Seat Width</b>			
HVS0009		36cm (14 Inches) (nc 17)	○
HVS0010		38cm (15 Inches)	○
HVS0011		41cm (16 Inches)	○
HVS0012		43cm (17 Inches) (nc 13)	○

<b>Seat Depth</b>			
HVS0013	33cm (13 Inches)		○
HVS0014	36cm (14 Inches)		○
HVS0015	38cm (15 Inches)		○
HVS0016	41cm (16 Inches)		○
HVS0017	43cm (17 Inches)		○
<b>Fabric Type</b>			
HVS0018	Standard Coloured Baltic Blue Wipedown (nc 4, 5)		◆
HVS0019	Black Smooth (nc 4, 5)		○
HVS0020	Black Wipedown (nc 4, 5)		○
HVS0034	Black Spacer (nc 4, 5)		○
<b>Cover Branding</b>			
HVS0022	Standard Invacare Branded Cover (nc 4, 5)		◆
<b>Cover Type</b>			
HVS0026	Sewn Cover (nc 4, 5)		◆
HVS0027	High Frequency Welded Cover (nc 4, 5, 8, 19, 20, 34)		○
<b>Liner</b>			
HVS0028	Platilon Liner Covering Moulded Foam (nc 3, 5)		○
HVS0029	No Platilon Liner Required		○
<b>Velcro</b>			
HVS0030	Velcro Pieces Sewn On Cover Base (nc 4, 5)		£26
HVS0031	No Velcro Required		○
<b>Homebrand Logo</b>			
HVS0032	Homebrand Logo (nc 4, 5, 19, 20, 21, 23, 24) Order qty over 50 units at one time. One off set up charge on first order		£26
HVS0033	No Homebrand Logo Required		○
			<b>Total Price</b>
			<b>Quantity</b>
<b>Accessories</b>			
1494494	Rigidiser W14" x D16"		£37
1487165	Rigidiser W16" x D16"		£37
1494495	Rigidiser W16" x D18"		£37
1494496	Rigidiser W16" x D20"		£72
1494497	Rigidiser W18" x D16"		£37
1494498	Rigidiser W18" x D18"		£37
1494499	Rigidiser W18" x D20"		£72
1494500	Rigidiser W20" x D16"		£37
1494501	Rigidiser W20" x D18"		£37
1494502	Rigidiser W20" x D20"		£72
1494503	Rigidiser W22" x D18"		£72
1494504	Rigidiser W22" x D20"		£72
<b>Office use only: Process cushion on configurator and accessories as line items.</b>			



Tel: 01656 776222 Fax: 01656 776220  
 Email: ordersuk@invacare.com  
 www.invacare.co.uk

**RETAIL PRESCRIPTION FORM**

Flo-Tech Contour Visco Medium cushion  
**April 2020**

<b>Customer name:</b>	<b>Account No :</b>
<b>Contact no:</b>	<b>Order No :</b>
<b>Delivery address:</b>	<b>Order Qty :</b>
	<b>Order Date :</b>

**Matrix Flo-Tech Contour Visco Medium**  
 Retail order form  
 Maximum User Weight 76kg (12 stone)

		WIDTH							
		cm	36	38	41	43	46	48	51
DEPTH	inch	14	15	16	17	18	19	20	
	33	13							
	36	14							
	38	15							
	41	16							
	43	17							
	46	18							
	48	19							
	51	20							
	53	21							

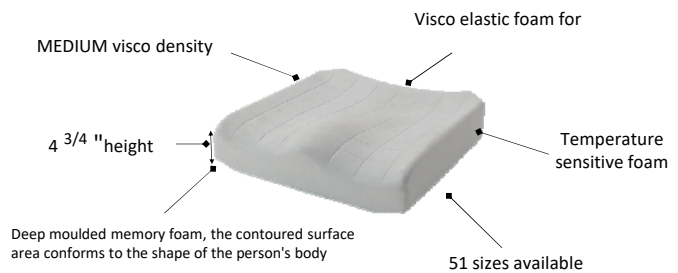

**Features**  
 High Risk/Elevated Risk  
 4 3/4" height  
 Two way stretch vapour permeable cover  
 Accessories available  
 Anti Slip Base with handle  
 3 Year Warranty

Code	X	Description	Price
<b>Flo-tech Contour Visco Medium</b>			
HVM0002		Complete Cushion	<b>£150</b>
HVM0003		Cover Only	<b>£59</b>
HVM0004		Foam Only	<b>£99</b>
HVM0005		Pack of 3 Replacement Platilon Liners	<b>£11</b>
<b>Foam Type</b>			
HVM0006		Medium Visco Foam (nc 5)	◆
<b>Base Type</b>			
HVM0007		Flat Base (nc 5)	○
HVM0008		Sag Infill Base (nc 5)	◆
<b>Seat Width</b>			
HVM0009		36cm (14 Inches) (nc 20, 21, 22, 23, 24)	○
HVM0010		38cm (15 Inches)	○
HVM0011		41cm (16 Inches)	○
HVM0012		43cm (17 Inches)	○

HVM0013	46cm (18 Inches)	○
HVM0014	48cm (19 Inches) (nc 16, 17)	○
HVM0015	51cm (20 Inches) (nc 16, 17, 22, 23, 24)	○
<b>Seat Depth</b>		
HVM0016	33cm (13 Inches)	○
HVM0017	36cm (14 Inches)	○
HVM0018	38cm (15 Inches)	○
HVM0019	41cm (16 Inches)	○
HVM0020	43cm (17 Inches)	○
HVM0021	46cm (18 Inches)	○
HVM0022	48cm (19 Inches)	○
HVM0023	51cm (20 Inches)	○
HVM0024	53cm (21 Inches)	○
<b>Fabric Type</b>		
HVM0025	Standard Coloured Baltic Blue Wipedown (nc 4, 5)	◆
HVM0026	Black Smooth (nc 4, 5)	○
HVM0027	Black Wipedown (nc 4, 5)	○
HVM0041	Black Spacer (nc 4, 5)	○
<b>Cover Branding</b>		
HVM0029	Standard Invacare Branded Cover (nc 4, 5)	◆
<b>Cover Type</b>		
HVM0033	Sewn Cover (nc 4, 5)	◆
HVM0034	High Frequency Welded Cover (nc 4, 5, 8, 26, 27, 41)	○
<b>Liner</b>		
HVM0035	Platilon Liner Covering Moulded Foam (nc 3, 5)	○
HVM0036	No Platilon Liner Required	○
<b>Velcro</b>		
HVM0037	Velcro Pieces Sewn On Cover Base (nc 4, 5)	£26
HVM0038	No Velcro Required	○
<b>Homebrand Logo</b>		
HVM0039	Homebrand Logo (nc 4, 5, 26, 27, 28, 30, 31) Order qty over 50 units at one time. One off set up charge on first order	£26
HVM0040	No Homebrand Logo Required	○
		<b>Total Price</b>
		<b>Quantity</b>
<b>Accessories</b>		
1494494	Rigidiser W14" x D16"	£37
1487165	Rigidiser W16" x D16"	£37
1494495	Rigidiser W16" x D18"	£37
1494496	Rigidiser W16" x D20"	£72
1494497	Rigidiser W18" x D16"	£37
1494498	Rigidiser W18" x D18"	£37
1494499	Rigidiser W18" x D20"	£72
1494500	Rigidiser W20" x D16"	£37
1494501	Rigidiser W20" x D18"	£37
1494502	Rigidiser W20" x D20"	£72
1494503	Rigidiser W22" x D18"	£72
1494504	Rigidiser W22" x D20"	£72
<b>Office use only: Process cushion on configurator and accessories as line items.</b>		



Tel: 01656 776222 Fax: 01656 776220  
Email: ordersuk@invacare.com  
www.invacare.co.uk

Flo-Tech Contour Visco Firm cushion  
**April 2020**

<b>Customer name:</b>	<b>Account No :</b>
<b>Contact no:</b>	<b>Order No :</b>
<b>Delivery address:</b>	<b>Order Qty :</b>
	<b>Order Date :</b>

**Matrix Flo-Tech Contour Visco Firm**  
Retail order form  
Maximum User Weight 102kg (16 stone)

		WIDTH							
		36	38	41	43	46	48	51	
		inch	14	15	16	17	18	19	20
DEPTH	cm	33	13						
	36	14							
	38	15							
	41	16							
	43	17							
	46	18							
	48	19							
	51	20							
53	21								

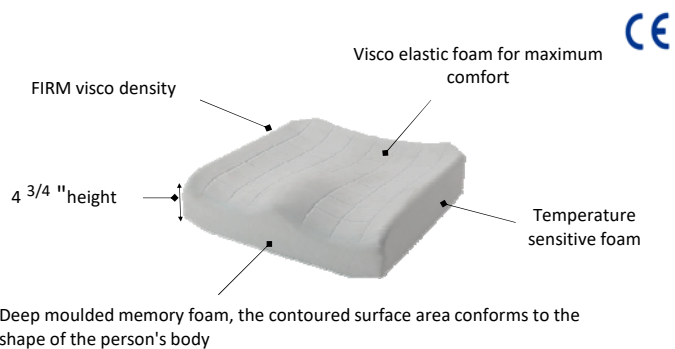

**Features**  
High Risk/Elevated Risk  
4 3/4" height  
Two way stretch vapour permeable cover  
Accessories available  
Anti Slip Base with handle  
3 Year Warranty



Code	X	Description	Price
<b>Flo-tech Contour Visco Firm</b>			
HVF0002		Complete Cushion	£150
HVF0003		Cover Only	£59
HVF0004		Foam Only	£99
HVF0005		Pack of 3 Replacement Platilon Liners	£11
<b>Foam Type</b>			
HVF0006		Firm Visco Foam (nc 5)	◆
<b>Base Type</b>			
HVF0007		Flat Base (nc 5)	○
HVF0008		Sag Infill Base (nc 5)	◆
<b>Seat Width</b>			
HVF0009		36cm (14 Inches) (nc 20, 21, 22, 23, 24)	○
HVF0010		38cm (15 Inches)	○
HVF0011		41cm (16 Inches)	○
HVF0012		43cm (17 Inches)	○
HVF0013		46cm (18 Inches)	○
HVF0014		48cm (19 Inches) (nc 16, 17)	○
HVF0015		51cm (20 Inches) (nc 16, 17, 22, 23, 24)	○
<b>Seat Depth</b>			
HVF0016		33cm (13 Inches)	○

HVF0017	36cm (14 Inches)	○
HVF0018	38cm (15 Inches)	○
HVF0019	41cm (16 Inches)	○
HVF0020	43cm (17 Inches)	○
HVF0021	46cm (18 Inches)	○
HVF0022	48cm (19 Inches)	○
HVF0023	51cm (20 Inches)	○
HVF0024	53cm (21 Inches)	○
<b>Fabric Type</b>		
HVF0025	Standard Coloured Baltic Blue Wipedown (nc 4, 5)	◆
HVF0026	Black Smooth (nc 4, 5)	○
HVF0027	Black Wipedown (nc 4, 5)	○
HVF0041	Black Spacer (nc 4, 5)	○
<b>Cover Branding</b>		
HVF0029	Standard Invacare Branded Cover (nc 4, 5)	◆
<b>Cover Type</b>		
HVF0033	Sewn Cover (nc 4, 5)	◆
HVF0034	High Frequency Welded Cover (nc 4, 5, 8, 26, 27, 41)	○
<b>Liner</b>		
HVF0035	Platilon Liner Covering Moulded Foam (nc 3, 5)	○
HVF0036	No Platilon Liner Required	○
<b>Velcro</b>		
HVF0037	Velcro Pieces Sewn On Cover Base (nc 4, 5)	£26
HVF0038	No Velcro Required	○
<b>Homebrand Logo</b>		
HVF0039	Homebrand Logo (nc 4, 5, 26, 27, 28, 30, 31) Order qty over 50 units at one time. One off set up charge on first order	£26
HVF0040	No Homebrand Logo Required	○
<b>Total Price</b>		
<b>Quantity</b>		
<b>Accessories</b>		
1494494	Rigidiser W14" x D16"	£37
1487165	Rigidiser W16" x D16"	£37
1494495	Rigidiser W16" x D18"	£37
1494496	Rigidiser W16" x D20"	£72
1494497	Rigidiser W18" x D16"	£37
1494498	Rigidiser W18" x D18"	£37
1494499	Rigidiser W18" x D20"	£72
1494500	Rigidiser W20" x D16"	£37
1494501	Rigidiser W20" x D18"	£37
1494502	Rigidiser W20" x D20"	£72
1494503	Rigidiser W22" x D18"	£72
1494504	Rigidiser W22" x D20"	£72
<b>Office use only: Process cushion on configurator and accessories as line items.</b>		



Yes, you can.

Tel: 01656 776222 Fax: 01656 776220  
 Email: ordersuk@invacare.com  
 www.invacare.co.uk

Flo-Tech Contour Visco V.firm cushion  
 April 2020

<b>Customer name:</b>	<b>Account No :</b>
<b>Contact no:</b>	<b>Order No :</b>
<b>Delivery address:</b>	<b>Order Qty :</b>
	<b>Order Date :</b>

**Matrx Flo-Tech Contour Visco V.Firm**  
 Retail order form  
 Maximum User Weight 125kg (20 stone)

		WIDTH					
cm		38	41	43	46	48	51
	inch	15	16	17	18	19	20
33	13						
36	14						
38	15						
41	16						
43	17						
46	18						
48	19						
51	20						
53	21						

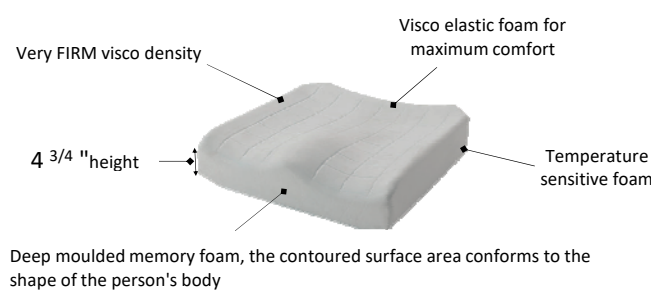

**Features**  
 High Risk/Elevated Risk  
 4 3/4" height  
 Two way stretch vapour permeable cover  
 Accessories available  
 Anti Slip Base with handle  
 3 Year Warranty



Code	X	Description	Price
<b>Flo-tech Contour Visco Very Firm</b>			
HVV0002		Complete Cushion	£150
HVV0003		Cover Only	£59
HVV0004		Foam Only	£99
HVV0005		Pack of 3 Replacement Platilon Liners	£11
<b>Foam Type</b>			
HVV0006		Very Firm Visco Foam (nc 5)	◆
<b>Base Type</b>			
HVV0007		Flat Base (nc 5)	○
HVV0008		Sag Infill Base (nc 5)	◆
<b>Seat Width</b>			
HVV0009		38cm (15 Inches) (nc 15)	○
HVV0010		41cm (16 Inches)	○
HVV0011		43cm (17 Inches)	○
HVV0012		46cm (18 Inches)	○
HVV0013		48cm (19 Inches) (nc 15, 16)	○
HVV0014		51cm (20 Inches) (nc 15, 16, 21, 22, 23)	○
<b>Seat Depth</b>			

HVV0015	33cm (13 Inches)	○
HVV0016	36cm (14 Inches)	○
HVV0017	38cm (15 Inches)	○
HVV0018	41cm (16 Inches)	○
HVV0019	43cm (17 Inches)	○
HVV0020	46cm (18 Inches)	○
HVV0021	48cm (19 Inches)	○
HVV0022	51cm (20 Inches)	○
HVV0023	53cm (21 Inches)	○
<b>Fabric Type</b>		
HVV0024	Standard Coloured Baltic Blue Wipedown (nc 4, 5)	◆
HVV0025	Black Smooth (nc 4, 5)	○
HVV0026	Black Wipedown (nc 4, 5)	○
HVV0040	Black Spacer (nc 4, 5)	○
<b>Cover Branding</b>		
HVV0028	Standard Invacare Branded Cover (nc 4, 5)	◆
<b>Cover Type</b>		
HVV0032	Sewn Cover (nc 4, 5)	◆
HVV0033	High Frequency Welded Cover (nc 4, 5, 8, 25, 26, 40)	○
<b>Liner</b>		
HVV0034	Platilon Liner Covering Moulded Foam (nc 3, 5)	○
HVV0035	No Platilon Liner Required	○
<b>Velcro</b>		
HVV0036	Velcro Pieces Sewn On Cover Base (nc 4, 5)	£26
HVV0037	No Velcro Required	○
<b>Homebrand Logo</b>		
HVV0038	Homebrand Logo (nc 4, 5, 25, 26, 27, 28, 30) Order qty over 50 units at one time. One off set up charge on first order	£26
HVV0039	No Homebrand Logo Required	○
<b>Total Price</b>		
<b>Quantity</b>		
<b>Accessories</b>		
1494494	Rigidiser W14" x D16"	£37
1487165	Rigidiser W16" x D16"	£37
1494495	Rigidiser W16" x D18"	£37
1494496	Rigidiser W16" x D20"	£72
1494497	Rigidiser W18" x D16"	£37
1494498	Rigidiser W18" x D18"	£37
1494499	Rigidiser W18" x D20"	£72
1494500	Rigidiser W20" x D16"	£37
1494501	Rigidiser W20" x D18"	£37
1494502	Rigidiser W20" x D20"	£72
1494503	Rigidiser W22" x D18"	£72
1494504	Rigidiser W22" x D20"	£72
<b>Office use only: Process cushion on configurator and accessories as line items.</b>		

Tel: 01656 776222 Fax: 01656 776220  
Email: ordersuk@invacare.com  
www.invacare.co.uk

Matrix Vi cushion  
April 2020

<b>Customer name:</b>	<b>Account No :</b>
<b>Contact no:</b>	<b>Order No :</b>
<b>Delivery address:</b>	<b>Order Qty :</b>
	<b>Order Date :</b>

**Matrix Vi Cushion**  
Retail order form  
Maximum User Weight 136kg (21 stone) / HD 272kg (43 stone)

		WIDTH						
cm		31	36	41	43	46	51	56
inch		12	14	16	17	18	20	22
DEPTH	31							
	36							
	38							
	41							
	43							
	46							
51								



**Features:**  
Suitable for High - very high risk  
Outer moisture resistant and breathable  
Inner wipe clean protective barrier  
3 layer construction with visco foam insert  
Anti slip base with handle  
2 year warranty



Code	X	Description	Price
<b>Matrix Vi Kidabra - Maximum User Weight 68kg/10.7 stone</b>			
KA1212-Vi		Matrix Vi 12x12" (31x31cm)	£328
KA1214-Vi		Matrix Vi 12x14" (31x36cm)	£328
KA1412-Vi		Matrix Vi 14x12" (36x31cm)	£328
KA1414-Vi		Matrix Vi 14x14" (36x36cm)	£328
<b>Matrix-Vi - Maximum User Weight 136kg/21 stone</b>			
MA1415-Vi		Matrix Vi cushion 14x15" (36x38cm)	£328
MA1417-Vi		Matrix Vi cushion 14x17" (36x43cm)	£328
MA1616-Vi		Matrix Vi cushion 16x16" (41x41cm)	£328
MA1618-Vi		Matrix Vi cushion 16x18" (41x46cm)	£328
MA1620-Vi		Matrix Vi cushion 16x20" (41x51cm)	£328
MA1716-Vi		Matrix Vi cushion 17x16" (43x41cm)	£328
MA1718-Vi		Matrix Vi cushion 17x18" (43x46cm)	£328
MA1720-Vi		Matrix Vi cushion 17x20" (43x51cm)	£328
MA1816-Vi		Matrix Vi cushion 18x16" (46x41cm)	£328
MA1818-Vi		Matrix Vi cushion 18x18" (46x46cm)	£328
MA1820-Vi		Matrix Vi cushion 18x20" (46x51cm)	£328
MA2016-Vi		Matrix Vi cushion 20x16" (51x46cm)	£328
MA2018-Vi		Matrix Vi cushion 20x18" (51x46cm)	£328
MA2020-Vi		Matrix Vi cushion 20x20" (51x51cm)	£328

<b>Matrx-Vi Heavy Duty - Maximum User Weight 272kg/43 stone</b>			
MA2218-Vi	Matrx Vi cushion 22x18" (56x46cm)		£413
MA2220-Vi	Matrx Vi cushion 22x20" (56x51cm)		£413
<b>Accessories</b>			
POK	Matrx Pelvic Obliquity Kit		£54
<b>Spare Covers</b>			
KC1212	Matrx Vi spare cover (12x12")	Kidabra	£91
KC1214	Matrx Vi spare cover (12x14")	Kidabra	£91
KC1412	Matrx Vi spare cover (14x12")	Kidabra	£91
KC1414	Matrx Vi spare cover (14x14")	Kidabra	£91
1579933	Matrx Vi spare cover (14x15")		£91
1579934	Matrx Vi spare cover (14x17")		£91
1579935	Matrx Vi spare cover (16x16")		£91
1579936	Matrx Vi spare cover (16x18")		£91
1579937	Matrx Vi spare cover (16x20")		£91
1579938	Matrx Vi spare cover (17x16")		£91
1579939	Matrx Vi spare cover (17x18")		£91
1579940	Matrx Vi spare cover (17x20")		£91
1579957	Matrx Vi spare cover (18x16")		£91
1579958	Matrx Vi spare cover (18x18")		£91
1579959	Matrx Vi spare cover (18x20")		£91
1579964	Matrx Vi spare cover (20x16")		£91
1579965	Matrx Vi spare cover (20x16")		£91
1579966	Matrx Vi spare cover (20x20")		£91
1579967	Matrx Vi spare cover (22x18")		£91
1580007	Matrx Vi spare cover (22x20")		£91
			<b>TOTAL PRICE:</b>
<b>Special Instructions - Extended lead times will apply</b>			
<b>Name:</b>	<b>Email:</b>	<b>Phone:</b>	
<b>Description of special request (please include relevant option code):</b>			



Yes, you can.®

Tel: 01656 776222 Fax: 01656 776220  
 Email: ordersuk@invacare.com  
 www.invacare.co.uk

Flo-tech Plus cushion  
 April 2020

<b>Customer name:</b>	<b>Account No :</b>
<b>Contact no:</b>	<b>Order No :</b>
<b>Delivery address:</b>	<b>Order Qty :</b>
	<b>Order Date :</b>

**Matrx Flo-tech Plus**  
 Retail order form  
 Maximum User Weight 191kg (30 stone)

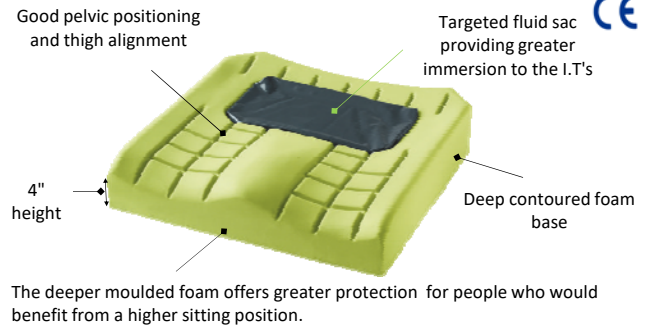
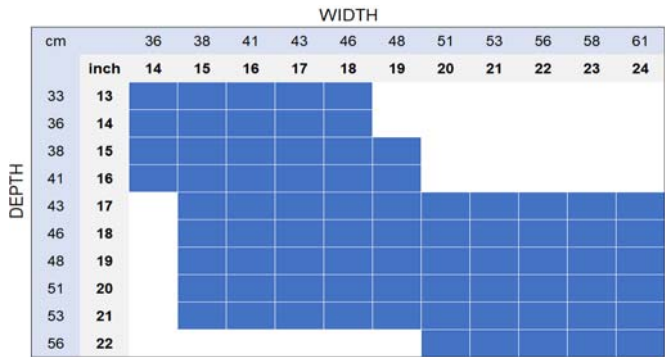

**Features**  
 High Risk/Elevated Risk  
 Two way stretch vapour permeable cover  
 Accessories available  
 Anti Slip Base with handle  
 3 Year Warranty

Code	X	Description	Price
<b>Flo-tech Plus</b>			
HFP0002		Complete Cushion	£214
HFP0003		Cover Only	£59
HFP0004		Foam Only	£104
HFP0005		Gel Only	£85
HFP0006		Pack of 3 Replacement Liners	£11
<b>Foam Type</b>			
HFP0007		Standard Foam (nc 3, 5, 6)	◆
<b>Base Type</b>			
HFP0008		Flat Base (nc 5, 6)	◆
HFP0009		Sag Infill Base (nc 5, 6)	○
<b>Seat Width</b>			
HFP0010		36cm (14 Inches) (nc 25, 26, 27, 28, 29, 30)	○
HFP0011		38cm (15 Inches) (nc 30)	○
HFP0012		41cm (16 Inches) (nc 30)	○
HFP0013		43cm (17 Inches) (nc 30)	○
HFP0014		46cm (18 Inches) (nc 30)	○
HFP0015		48cm (19 Inches) (nc 21, 22, 30)	○
HFP0016		51cm (20 Inches) (nc 21, 22, 23, 24)	○

HFP0017	53cm (21 Inches) (nc 21, 22, 23, 24)	○
HFP0018	55cm (22 Inches) (nc 21, 22, 23, 24)	○
HFP0019	58cm (23 Inches) (nc 21, 22, 23, 24)	○
HFP0020	60cm (24 Inches) (nc 21, 22, 23, 24)	○
<b>Seat Depth</b>		
HFP0021	33cm (13 Inches)	○
HFP0022	36cm (14 Inches)	○
HFP0023	38cm (15 Inches)	○
HFP0024	41cm (16 Inches)	○
HFP0025	43cm (17 Inches)	○
HFP0026	46cm (18 Inches)	○
HFP0027	48cm (19 Inches)	○
HFP0028	51cm (20 Inches)	○
HFP0029	53cm (21 Inches)	○
HFP0030	55cm (22 Inches)	○
<b>Fabric Type</b>		
HFP0031	Standard Coloured Baltic Blue Wipedown (nc 4, 5, 6)	◆
HFP0032	Black Smooth (nc 4, 5, 6)	○
HFP0033	Black Wipedown (nc 4, 5, 6)	○
HFP0047	Black Spacer (nc 4, 5, 6)	○
<b>Cover Branding</b>		
HFP0035	Standard Invacare Branded Cover (nc 4, 5, 6)	◆
<b>Cover Type</b>		
HFP0039	Sewn Cover (nc 4, 5, 6)	◆
HFP0040	High Frequency Welded Cover (nc 4, 5, 6, 9, 32, 33, 47)	○
<b>Liner</b>		
HFP0041	Platilon Liner Covering Moulded Foam (nc 3, 4, 5, 6)	○
HFP0042	No Liner Required	○
<b>Velcro</b>		
HFP0043	Velcro Pieces Sewn On Cover Base (nc 4, 5, 6)	£26
HFP0044	No Velcro Required	○
<b>Homebrand Logo</b>		
HFP0045	Homebrand Logo (nc 4, 5, 6, 32, 33, 34, 36, 37) Order qty over 50 units at one time. One off set up charge on first order	£26
HFP0046	No Homebrand Logo Required	○
		<b>Total Price</b>
		<b>Quantity</b>
<b>Accessories</b>		
1494494	Rigidiser W14" x D16"	£37
1487165	Rigidiser W16" x D16"	£37
1494495	Rigidiser W16" x D18"	£37
1494496	Rigidiser W16" x D20"	£72
1494497	Rigidiser W18" x D16"	£37
1494498	Rigidiser W18" x D18"	£37
1494499	Rigidiser W18" x D20"	£72
1494500	Rigidiser W20" x D16"	£37
1494501	Rigidiser W20" x D18"	£37
1494502	Rigidiser W20" x D20"	£72
1494503	Rigidiser W22" x D18"	£72
1494504	Rigidiser W22" x D20"	£72
<b>Office use only: Process cushion on configurator and accessories as line items.</b>		



Tel: 01656 776222 Fax: 01656 776220  
Email: ordersuk@invacare.com  
www.invacare.co.uk

<b>Customer name:</b>	<b>Account No :</b>
<b>Contact no:</b>	<b>Order No :</b>
<b>Delivery address:</b>	<b>Order Qty :</b>
	<b>Order Date :</b>

**Matrx Flo-Tech Image**  
Retail order form  
Maximum User Weight 140kg (22 stone)

		WIDTH							
cm		36	38	41	43	46	48	51	
inch		14	15	16	17	18	19	20	
DEPTH	33								
	36								
	38								
	41								
	43								
	46								
	48								
	51								
53									

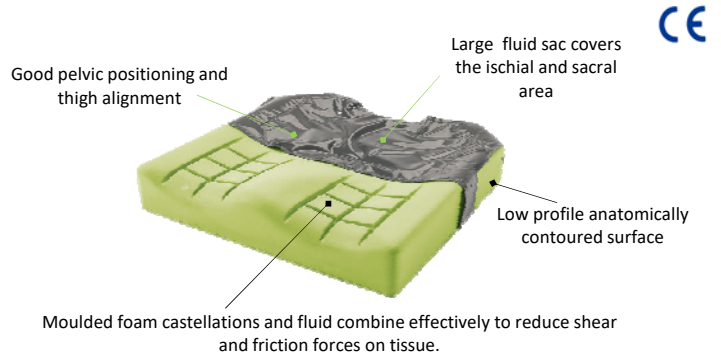

**Features**  
Features High Risk/Elevated Risk  
3" height  
Two way stretch vapour permeable cover  
Accessories available  
Anti Slip Base with handle  
3 Year Warranty





Code	X	Description	Price
<b>Flo-tech Image</b>			
HFI0002		Complete Cushion	£256
HFI0003		Cover Only	£59
HFI0004		Foam only	£104
HFI0005		Gel only	£125
HFI0006		Pack of 3 Replacement Platilon Liners	£11
<b>Foam Type</b>			
HFI0007		Standard Foam (nc 3, 5, 6)	◆
<b>Base Type</b>			
HFI0008		Flat Base (nc 5, 6)	◆
HFI0009		Sag Infill Base (nc 5, 6)	○
<b>Seat Width</b>			
HFI0010		36cm (14 Inches) (nc 21, 22, 23, 24, 25)	○
HFI0011		38cm (15 Inches)	○
HFI0012		41cm (16 Inches)	○
HFI0013		43cm (17 Inches)	○

HFI0014	46cm (18 Inches)	○
HFI0015	48cm (19 Inches) (nc 17, 18)	○
HFI0016	51cm (20 Inches) (nc 17, 18, 23, 24, 25)	○
<b>Seat Depth</b>		
HFI0017	33cm (13 Inches)	○
HFI0018	36cm (14 Inches)	○
HFI0019	38cm (15 Inches)	○
HFI0020	41cm (16 Inches)	○
HFI0021	43cm (17 Inches)	○
HFI0022	46cm (18 Inches)	○
HFI0023	48cm (19 Inches)	○
HFI0024	51cm (20 Inches)	○
HFI0025	53cm (21 Inches)	○
<b>Fabric Type</b>		
HFI0026	Standard Coloured Baltic Blue Wipedown (nc 4, 5, 6)	◆
HFI0027	Black Smooth (nc 4, 5, 6)	○
HFI0028	Black Wipedown (nc 4, 5, 6)	○
HFI0042	Black Spacer (nc 4, 5, 6)	○
<b>Cover Branding</b>		
HFI0030	Standard Invacare Branded Cover (nc 4, 5, 6)	◆
<b>Cover Type</b>		
HFI0034	Sewn Cover (nc 4, 5, 6)	◆
HFI0035	High Frequency Welded Cover (nc 4, 5, 6, 9, 27, 28, 42)	○
<b>Liner</b>		
HFI0036	Platilon Liner Covering Moulded Foam (nc 3, 4, 5, 6)	◆
HFI0037	No Platilon Liner Required (nc 2)	○
<b>Velcro</b>		
HFI0038	Velcro Pieces Sewn On Cover Base (nc 4, 5, 6)	£26
HFI0039	No Velcro Required	○
<b>Homebrand Logo</b>		
HFI0040	Homebrand Logo (nc 4, 5, 6, 27, 28) Order qty over 50 units at one time. One off set up charge on 1st order	£26
HFI0041	No Homebrand Logo Required	○
<b>Total Price</b>		
<b>Quantity</b>		
<b>Accessories</b>		
1494494	Rigidiser W14" x D16"	£37
1487165	Rigidiser W16" x D16"	£37
1494495	Rigidiser W16" x D18"	£37
1494496	Rigidiser W16" x D20"	£72
1494497	Rigidiser W18" x D16"	£37
1494498	Rigidiser W18" x D18"	£37
1494499	Rigidiser W18" x D20"	£72
1494500	Rigidiser W20" x D16"	£37
1494501	Rigidiser W20" x D18"	£37
1494502	Rigidiser W20" x D20"	£72
1494503	Rigidiser W22" x D18"	£72
1494504	Rigidiser W22" x D20"	£72
<b>Office use only: Process cushion on configurator and accessories as line items.</b>		



Yes, you can.®

Tel: 01656 776222 Fax: 01656 776220  
 Email: ordersuk@invacare.com  
 www.invacare.co.uk

Flo-Tech Solution cushion  
 April 2020

<b>Customer name:</b>	<b>Account No :</b>
<b>Contact no:</b>	<b>Order No :</b>
<b>Delivery address:</b>	<b>Order Qty :</b>
	<b>Order Date :</b>

**Matrix Flo-Tech Solution**  
 Retail order form  
 Maximum User Weight 140kg (22 stone)



		WIDTH											
cm		36	38	41	43	46	48	51	53	56	58	61	
inch		14	15	16	17	18	19	20	21	22	23	24	
DEPTH	33	■											
	36	■											
	38	■											
	41	■											
	43	■											
	46	■											
	48	■											
	51	■											
53	■												
56	■												

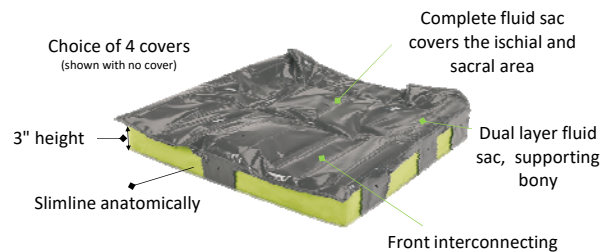

**Features**  
 Very High Risk/Elevated Risk  
 Two way stretch vapour permeable cover  
 3" cushion height  
 Anti Slip Base  
 3 Year Warranty





Code	X	Description	Price
HFS0002		Complete Cushion	£328
HFS0003		Cover Only	£59
HFS0004		Foam Only	£104
HFS0005		Gel Only	£176
HFS0006		Pack of 3 Replacement Platilon Liners	£11
<b>Foam Type</b>			
HFS0007	X	Standard Foam (nc 3, 5, 6)	◆
<b>Base Type</b>			
HFS0008		Flat Base (nc 5, 6)	◆
HFS0009		Sag Infill Base (nc 5, 6)	○
<b>Seat Width</b>			
HFS0010		36cm (14 Inches) (nc 25, 26, 27, 28, 29, 30)	○
HFS0011		38cm (15 Inches) (nc 30)	○
HFS0012		41cm (16 Inches) (nc 30)	○
HFS0013		43cm (17 Inches) (nc 30)	○
HFS0014		46cm (18 Inches) (nc 30)	○
HFS0015		48cm (19 Inches) (nc 21, 22, 30)	○
HFS0016		51cm (20 Inches) (nc 21, 22)	○

HFS0017	53cm (21 Inches) (nc 21, 22, 23, 24)	○
HFS0018	55cm (22 Inches) (nc 21, 22, 23, 24)	○
HFS0019	58cm (23 Inches) (nc 21, 22, 23, 24)	○
HFS0020	60cm (24 Inches) (nc 21, 22, 23, 24)	○
<b>Seat Depth</b>		
HFS0021	33cm (13 Inches)	○
HFS0022	36cm (14 Inches)	○
HFS0023	38cm (15 Inches)	○
HFS0024	41cm (16 Inches)	○
HFS0025	43cm (17 Inches)	○
HFS0026	46cm (18 Inches)	○
HFS0027	48cm (19 Inches)	○
HFS0028	51cm (20 Inches)	○
HFS0029	53cm (21 Inches)	○
HFS0030	55cm (22 Inches)	○
<b>Fabric Type</b>		
HFS0031	Standard Coloured Baltic Blue Wipedown (nc 4, 5, 6)	◆
HFS0032	Black Smooth (nc 4, 5, 6)	○
HFS0033	Black Wipedown (nc 4, 5, 6)	○
HFS0047	Black Spacer (nc 4, 5, 6)	○
<b>Cover Branding</b>		
HFS0035	Standard Invacare Branded Cover (nc 4, 5, 6)	◆
<b>Cover Type</b>		
HFS0039	Sewn Cover (nc 4, 5, 6)	◆
HFS0040	High Frequency Welded Cover (nc 4, 5, 6, 9, 32, 33, 47)	○
<b>Liner</b>		
HFS0041	Platilon Liner Covering Moulded Foam (nc 3, 4, 5, 6)	◆
HFS0042	No Platilon Liner Required (nc 2)	○
<b>Velcro</b>		
HFS0043	Velcro Pieces Sewn On Cover Base (nc 4, 5, 6)	£26
HFS0044	No Velcro Required	○
<b>Homebrand Logo</b>		
HFS0045	Homebrand Logo (nc 4, 5, 6, 32, 33, 34, 36, 37) Order qty over 50 units at one time. One off set up charge on first order	£26
HFS0046	No Homebrand Logo Required	○
		<b>Total Price</b>
		<b>Quantity</b>
<b>Accessories</b>		
1494494	Rigidiser W14" x D16"	£37
1487165	Rigidiser W16" x D16"	£37
1494495	Rigidiser W16" x D18"	£37
1494496	Rigidiser W16" x D20"	£72
1494497	Rigidiser W18" x D16"	£37
1494498	Rigidiser W18" x D18"	£37
1494499	Rigidiser W18" x D20"	£72
1494500	Rigidiser W20" x D16"	£37
1494501	Rigidiser W20" x D18"	£37
1494502	Rigidiser W20" x D20"	£72
1494503	Rigidiser W22" x D18"	£72
1494504	Rigidiser W22" x D20"	£72
		<b>Total Price</b>
<b>Office use only: Process cushion on configurator and accessories as line items.</b>		



Yes, you can.®

Tel: 01656 776222 Fax: 01656 776220  
 Email: ordersuk@invacare.com  
 www.invacare.co.uk

RETAIL PRESCRIPTION FORM

Flo-Tech Deep Solution cushion  
 April 2020

<b>Customer name:</b>	<b>Account No :</b>
<b>Contact no:</b>	<b>Order No :</b>
<b>Delivery address:</b>	<b>Order Qty :</b>
	<b>Order Date :</b>

**Matrx Flo-Tech Deep Solution**  
 Retail order form  
 Maximum User Weight 140kg (22 stone)

		WIDTH			
		cm	46	48	51
		inch	18	19	20
DEPTH	38	15			
	41	16			
	43	17			
	46	18			

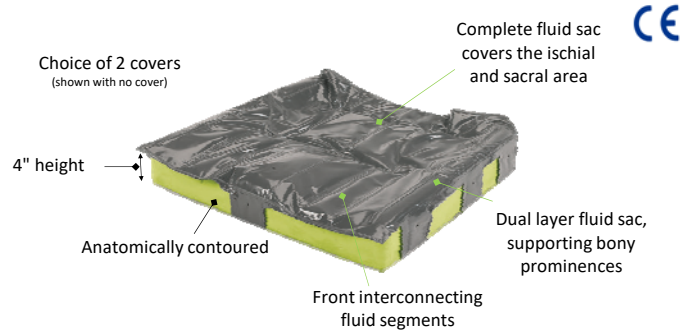

**Features**  
 Very High Risk/Elevated Risk  
 4" cushion height  
 Two way stretch vapour permeable cover  
 Anti Slip Base with handle  
 3 Year Warranty

Code	X	Description	Price
<b>Flo-tech Deep Solution</b>			
HDS0002		Complete Cushion	£346
HDS0003		Cover Only	£59
HDS0004		Foam Only	£110
HDS0005		Gel Only	£197
HDS0006		Pack of 3 Replacement Platilon Liners	£11
<b>Foam Type</b>			
HDS0007		Standard Foam (nc 3, 5, 6)	◆
<b>Base Type</b>			
HDS0008		Flat Base (nc 5, 6)	◆
HDS0009		Sag Infill Base (nc 5, 6)	○
<b>Seat Width</b>			
HDS0010		46cm (18 Inches)	○
HDS0011		48cm (19 Inches)	○
HDS0012		51cm (20 Inches)	○
<b>Seat Depth</b>			
HDS0013		38cm (15 Inches)	○
HDS0014		41cm (16 Inches)	○
HDS0015		43cm (17 Inches)	○
HDS0016		46cm (18 Inches)	○

<b>Fabric Type</b>			
HDS0017		Standard Coloured Baltic Blue Wipedown (nc 4, 5, 6)	◆
HDS0018		Black Smooth (nc 4, 5, 6)	○
HDS0019		Black Wipedown (nc 4, 5, 6)	○
HDS0033		Black Spacer (nc 4, 5, 6)	○
<b>Cover Branding</b>			
HDS0021		Standard Invacare Branded Cover (nc 4, 5, 6)	◆
<b>Cover Type</b>			
HDS0025		Sewn Cover (nc 4, 5, 6)	◆
HDS0026		High Frequency Welded Cover (nc 4, 5, 6, 9, 18, 19, 20, 33)	○
<b>Liner</b>			
HDS0027		Platilon Liner Covering Moulded Foam (nc 3, 4, 5, 6)	◆
HDS0028		No Platilon Liner Required (nc 2)	○
<b>Velcro</b>			
HDS0029		Velcro Pieces Sewn On Cover Base (nc 4, 5, 6)	£26
HDS0030		No Velcro Required	○
<b>Homebrand Logo</b>			
HDS0031		Homebrand Logo (nc 4, 5, 6, 18, 19, 20) Order qty over 50 units at one time. One off set up charge on first order	£26
HDS0032		No Homebrand Logo Required	○
			<b>Total Price</b>
			<b>Quantity</b>
<b>Accessories</b>			
1494494		Rigidiser W14" x D16"	£37
1487165		Rigidiser W16" x D16"	£37
1494495		Rigidiser W16" x D18"	£37
1494496		Rigidiser W16" x D20"	£72
1494497		Rigidiser W18" x D16"	£37
1494498		Rigidiser W18" x D18"	£37
1494499		Rigidiser W18" x D20"	£72
1494500		Rigidiser W20" x D16"	£37
1494501		Rigidiser W20" x D18"	£37
1494502		Rigidiser W20" x D20"	£72
1494503		Rigidiser W22" x D18"	£72
1494504		Rigidiser W22" x D20"	£72
			<b>Total Price</b>
<b>Office use only: Process cushion on configurator and accessories as line items.</b>			



Yes, you can.®

Tel: 01656 776222 Fax: 01656 776220  
 Email: ordersuk@invacare.com  
 www.invacare.co.uk

Solution Xtra cushion  
 April 2020

<b>Customer name:</b>	<b>Account No :</b>
<b>Contact no:</b>	<b>Order No :</b>
<b>Delivery address:</b>	<b>Order Qty :</b>
	<b>Order Date :</b>

**Matrix Flo-Tech Solution Xtra**  
 Retail order form  
 Maximum User Weight 140kg (22 stone)

		WIDTH											
cm		36	38	41	43	46	48	51	53	56	58	61	
inch		14	15	16	17	18	19	20	21	22	23	24	
DEPTH	31	■											
	33	■											
	36	■											
	38	■											
	41	■											
	43	■											
	46	■											
	48	■											
	51	■											
	53	■											
56	■												



**Features**  
 Very High Risk/Elevated Risk  
 3" height  
 Cover expandable for addition of modular accessories  
 Two way stretch vapour permeable cover  
 Accessories available  
 Anti Slip Base  
 3 Year Warranty ( 1 year on accessories)

Code	X	Description	Price
<b>Solution Xtra cushion</b>			
HSX0002		Complete Cushion	£354
HSX0003		Cover Only	£66
HSX0004		Foam Only	£131
HSX0005		Gel Only	£176
HSX0006		Pack of 3 Replacement Plaiton Liners	£21
<b>Foam Type</b>			
HSX0007		Standard Foam (nc 3, 5, 6)	◆
<b>Base Type</b>			
HSX0008		Flat Base (nc 5, 6)	◆
<b>Seat Width</b>			
HSX0010		36cm (14 Inches) (nc 25, 26, 27, 28, 29 ,30)	○
HSX0011		38cm (15 Inches) (nc 30)	○
HSX0012		41cm (16 Inches) (nc 30)	○
HSX0013		43cm (17 Inches) (nc 30)	○
HSX0014		46cm (18 Inches) (nc 30)	○

HSX0015	48cm (19 Inches) (nc 21, 22, 30)	○
HSX0016	51cm (20 Inches) (nc 21, 22)	○
HSX0017	53cm (21 Inches) (nc 21, 22, 23, 24)	○
HSX0018	55cm (22 Inches) (nc 21, 22, 23, 24)	○
HSX0019	58cm (23 Inches) (nc 21, 22, 23, 24)	○
HSX0020	60cm (24 Inches) (nc 21, 22, 23, 24)	○
<b>Seat Depth</b>		
HSX0021	33cm (13 Inches)	○
HSX0022	36cm (14 Inches)	○
HSX0023	38cm (15 Inches)	○
HSX0024	41cm (16 Inches)	○
HSX0025	43cm (17 Inches)	○
HSX0026	46cm (18 Inches)	○
HSX0027	48cm (19 Inches)	○
HSX0028	51cm (20 Inches)	○
HSX0029	53cm (21 Inches)	○
HSX0030	55cm (22 Inches)	○
<b>Fabric Type</b>		
HSX0031	Black Smooth (nc 4, 5, 6)	◆
HSX0041	Black Spacer (nc 4, 5, 6)	○
<b>Cover Branding</b>		
HSX0032	Standard Invacare Branded Cover (nc 4, 5, 6)	◆
<b>Cover Type</b>		
HSX0036	Sewn Cover (nc 4, 5, 6)	◆
<b>Liner</b>		
HSX0037	Platilon Liner Covering Moulded Foam (nc 3, 4, 5, 6)	◆
HSX0038	No Platilon Liner Required (nc 2)	○
<b>Velcro</b>		
HSX0039	Velcro Pieces Sewn On Cover Base (nc 4, 5, 6)	£26
HSX0040	No Velcro Required	○
<b>Total Price</b>		
<b>Quantity</b>		
<b>Accessories</b>		
1487155	Lateral Tapered Wedge (single)	£29
1487157	Front Wedge (single)	£26
1487158	Side Wedge (pair)	£19
1487160	Thigh Aligner (single)	£21
1487161	Hip Aligner (single)	£16
1487162	Large Pommel (single)	£22
1487163	Small Pommel (single)	£16
1487164	Pelvic Obliquity Pad (single)	£19
1487166	Fluid Sac (single)	£42
1487270	Complete Modular System - Comprises of all the above items in an assessment box with instruction manual (Rigidiser size 16"x16") N.B. does not include cushion	£378
1494494	Rigidiser W14" x D16"	£37
1487165	Rigidiser W16" x D16"	£37
1494495	Rigidiser W16" x D18"	£37
1494496	Rigidiser W16" x D20"	£72
1494497	Rigidiser W18" x D16"	£37
1494498	Rigidiser W18" x D18"	£37
1494499	Rigidiser W18" x D20"	£72
1494500	Rigidiser W20" x D16"	£37
1494501	Rigidiser W20" x D18"	£37
1494502	Rigidiser W20" x D20"	£72
1494503	Rigidiser W22" x D18"	£72
1494504	Rigidiser W22" x D20"	£72
<b>Total Price</b>		
<b>Office use only: Process cushion on configurator and accessories as line items. Add 'do not part ship' to notes</b>		



Tel: 01656 776222 Fax: 01656 776220  
Email: ordersuk@invacare.com  
www.invacare.co.uk

<b>Customer name:</b>	<b>Account No :</b>
<b>Contact no:</b>	<b>Order No :</b>
<b>Delivery address:</b>	<b>Order Qty :</b>
	<b>Order Date :</b>

**Matrx Libra**  
Retail order Form  
Maximum User Weight 21 stone (136kg) / HD 36 stone (227kg)

		WIDTH								
cm		36	38	41	43	46	48	51	53	56
inch		14	15	16	17	18	19	20	21	22
DEPTH	30									
	36									
	41									
	43									
	46									
	51									
56										

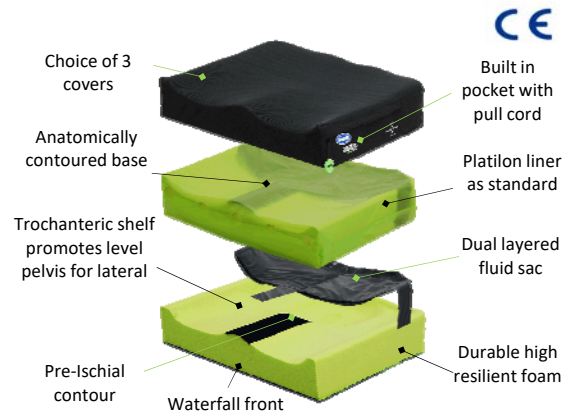

**Ordering the correct size**

Please note the complete product dimensions. The example shown is of a 16"x16" cushion part number LC1616. Please allow an additional 1 1/2" to the required seat depth for the rear cushion radius.

The rear cushion radius is a curved extension designed to maximise surface area and minimise the gap between seat and backrest; while stabilising fluid in tilted positions, with coccyx cut out for added relief.

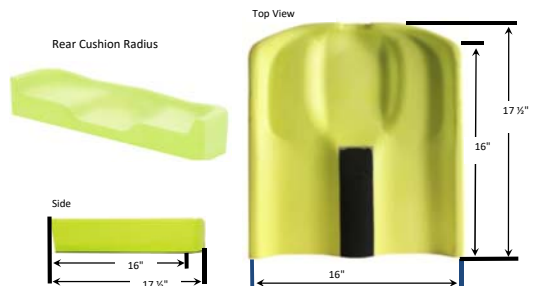

- Features:**  
Very High Risk  
3" height  
3 Year Warranty  
Anatomically contoured foam base Innovative dual layer fluid sac  
Choice of 3 covers  
Positioning accessories available



Code	X	Description	Price
<b>Libra Cushion</b>			
LC _____ (Width x Depth)		Matrx Libra standard sizes with black smooth cover	£354
LCW _____ (Width x Depth)		Matrx Libra standard sizes with black wipedown cover	£354
LCS _____ (Width x Depth)		Matrx Libra standard sizes with black spacer cover	£354

## Heavy Duty sizes

LC2117	Heavy Duty Libra 21x17" (53x43cm)	Black Smooth cover	£486
LC2118	Heavy Duty Libra 21x18" (53x46cm)	Black Smooth cover	£486
LC2120	Heavy Duty Libra 21x20" (53x51cm)	Black Smooth cover	£486
LC2122	Heavy Duty Libra 21x22" (53x56cm)	Black Smooth cover	£486
LC2217	Heavy Duty Libra 22x17" (56x43cm)	Black Smooth cover	£486
LC2218	Heavy Duty Libra 22x18" (56x46cm)	Black Smooth cover	£486
LC2220	Heavy Duty Libra 22x20" (56x51cm)	Black Smooth cover	£486
LC2222	Heavy Duty Libra 22x22" (56x56cm)	Black Smooth cover	£486
LCW2117	Heavy Duty Libra 21x17" (53x43cm)	Black Wipedown Cover	£486
LCW2118	Heavy Duty Libra 21x18" (53x46cm)	Black Wipedown Cover	£486
LCW2120	Heavy Duty Libra 21x20" (53x51cm)	Black Wipedown Cover	£486
LCW2122	Heavy Duty Libra 21x22" (53x56cm)	Black Wipedown Cover	£486
LCW2217	Heavy Duty Libra 22x18" (56x43cm)	Black Wipedown Cover	£486
LCW2218	Heavy Duty Libra 22x18" (56x46cm)	Black Wipedown Cover	£486
LCW2220	Heavy Duty Libra 22x20" (56x51cm)	Black Wipedown Cover	£486
LCW2222	Heavy Duty Libra 22x22" (56x56cm)	Black Wipedown Cover	£486
LCS2117	Heavy Duty Libra 21x17" (53x43cm)	Spacer Fabric Cover	£486
LCS2118	Heavy Duty Libra 21x18" (53x46cm)	Spacer Fabric Cover	£486
LCS2120	Heavy Duty Libra 21x20" (53x51cm)	Spacer Fabric Cover	£486
LCS2122	Heavy Duty Libra 21x22" (53x56cm)	Spacer Fabric Cover	£486
LCS2217	Heavy Duty Libra 22x17" (56x43cm)	Spacer Fabric Cover	£486
LCS2218	Heavy Duty Libra 22x18" (56x46cm)	Spacer Fabric Cover	£486
LCS2220	Heavy Duty Libra 22x20" (56x51cm)	Spacer Fabric Cover	£486
LCS2222	Heavy Duty Libra 22x22" (56x56cm)	Spacer Fabric Cover	£486

## Accessories



LABD	<b>Matrix Abductor</b> For comfortable mid-line positioning of thighs and hips (Provides 1 1/8" (29mm) increased height abductor contour)		<b>£35</b>
1487157	<b>Anterior Seat Wedge</b> Increases slope, prevents sliding and reduces shear (1" Anterior wedge increases pre-ischial contour - Underside mounted)		<b>£26</b>
1487158	<b>Tapered Wedges (pair)</b> For obliquity and pelvic rotation when used in rear (3/4" Tapered wedge - Underside mounted)		<b>£18</b>
1487155	<b>Lateral Wedge</b> Reinforces lateral stability for enhanced midline positioning (1" Lateral wedge increases hip/thigh loading, - Underside mounted)		<b>£29</b>
1578357	<b>Libra Fluid Supplement</b> For targeted protection/obliquity accommodation (May be used to accommodate mild pelvic obliquity/additional pressure reduction)		<b>£48</b>
1589366	<b>Libra Accessory Kit</b> Comprises of all the above items in an assessment presentation box with instruction guide. Parts included: LABD, 1487157, 1487158, 1487155, 1578357		<b>£107</b>
	<b>Spare Plaitlon Inner Liner</b> Provides added protection to the foam cushion from infection control issues.		<b>£12</b>
	<b>Additional Cover (Widths 14" to 20")</b>	<input type="checkbox"/> Black Smooth <input type="checkbox"/> Black Spacer <input type="checkbox"/> Black Wipedown	<b>£91</b>
	<b>Additional Cover (Widths 21" and over )</b>	<input type="checkbox"/> Black Smooth <input type="checkbox"/> Black Spacer <input type="checkbox"/> Black Wipedown	<b>£107</b>
1494494	14" x 16" Rigidiser		<b>£37</b>
1487165	16" x 16" Rigidiser		<b>£37</b>
1494495	16" x 18" Rigidiser		<b>£37</b>
1494496	16" x 20" Rigidiser		<b>£72</b>
1494497	18" x 16" Rigidiser		<b>£37</b>
1494498	18" x 18" Rigidiser		<b>£37</b>
1494499	18" x 20" Rigidiser		<b>£72</b>
1494500	20" x 16" Rigidiser		<b>£37</b>
1494501	20" x 18" Rigidiser		<b>£37</b>
1494502	20" x 20" Rigidiser		<b>£72</b>
1494503	22" x 18" Rigidiser		<b>£72</b>
1494504	22" x 20" Rigidiser		<b>£72</b>
<b>TOTAL PRICE:</b>			

**Special Instructions - Extended lead times will apply**

**Name:**

**Email:**

**Phone:**



Description of special request (please include relevant option code):





Yes, you can.

Tel: 01656 776222 Fax: 01656 776220

Email: ordersuk@invacare.com

www.invacare.co.uk

### RETAIL PRESCRIPTION FORM

Vicair Liberty cushion

April 2020

Customer Name :	Account No :
Address :	Order No :
Tel Number :	Order Qty :
Delivery Address :	Order Date :

**Vicair Liberty**  
Retail order form  
Max user weight 150 kg (23 stone)

#### 6cm Height

inch		16	17 <sup>1/4</sup>	18	19	20
	cm	40	43	45	48	50
16	40					
17 <sup>1/4</sup>	43					
18	45					
19	48					
20	50					

Standard size       Not available



**Standard Features:**  
 Lightweight, waterproof & low maintenance cushion  
 Compartment barrier gently prevents sliding forward  
 Equal pressure distribution on the seating surface  
 Auto-adjusting air valve  
 Adjusts to body shape and weight  
 Easy to clean and disinfect

Code	X	Description	Price
<b>Standard sizes</b>			
LBA/CK/_____		Liberty cushion with Comfair cover	£162
LBA/IN/_____		Liberty cushion with Incotec cover	£162
(Specify width, depth in cm)			
<b>TOTAL PRICE:</b>			

**Special Instructions - Please supply the following information:**



**Name:** \_\_\_\_\_ **Email:** \_\_\_\_\_ **Phone:** \_\_\_\_\_

Description of special request (please include relevant option code):





Tel: 01656 776222 Fax: 01656 776220  
Email: ordersuk@invacare.com  
www.invacare.co.uk

Customer Name :	Account No :
Address :	Order No :
Tel Number :	Order Qty :
Delivery Address :	Order Date :

**Vicair Liberty TC**  
Retail order form  
Max user weight 150 kg (23 stone)

**Standard Features:**  
Transforms the hard toilet seat into a comfortable seating surface  
Straps easily attach onto the toilet seat  
Watertight making it easy to clean and disinfect  
Height 5 cm  
Average weight 350 grams  
Max. user weight 150 kg  
Warranty 24 months



Code	X	Description			Price
<b>Liberty toilet cushion</b>					
LTC/1		Liberty TC 1	43x43cm	17 1/4 x 17 1/4 x 2"	£206
LTC/2		Liberty TC 2	50x45cm	20x18"	£206
LTC/3		Liberty TC 3	45x50cm	18x20"	£238
<b>TOTAL PRICE:</b>					

**Special Instructions - Please supply the following information:**



**Name:** \_\_\_\_\_ **Email:** \_\_\_\_\_ **Phone:** \_\_\_\_\_

**Description of special request (please include relevant option code):**





Tel: 01656 776222 Fax: 01656 776220  
 Email: ordersuk@invacare.com  
 www.invacare.co.uk

Vicair Positioner  
 April 2020

Customer Name :	Account No :
Address :	Order No :
Tel Number :	Order Qty :
Delivery Address :	Order Date :

**Vicair Positioner**  
 Retail order form  
 Max user weight 250kg (39 stone)

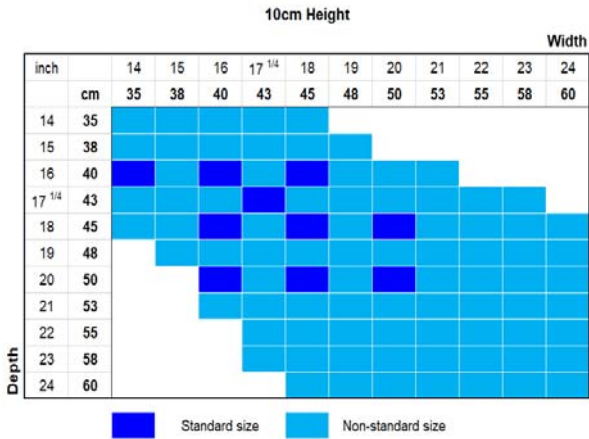
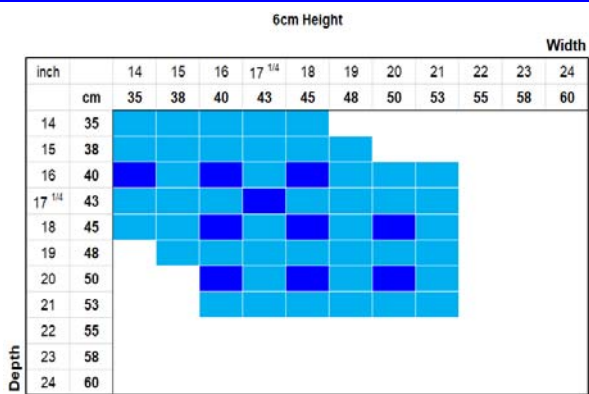

**Standard Features:**

- Two side compartments for lateral stability
- High quality pressure redistribution and immersion in the pelvic area
- High support: firmer density to provide lateral stability
- Front compartment provides leg-guidance and stability
- Choice of 6 or 10cm heights

RETIRING MODEL: AVAILABLE UNTIL DECEMBER 2020 ONLY

Code	X	Description	Price
<b>Standard size - 6cm height</b>			
APP6/CC/ _____		Positioner 6 with Comfair cover	£586
APP6/CI/ _____		Positioner 6 with Incotec cover	£586
(Specify width x depth in cm)			
<b>Non-standard size - 6cm height</b>			
APP6/CC/ _____		Positioner 6 with Comfair cover	£685
APP6/CI/ _____		Positioner 6 with Incotec cover	£685
(Specify width x depth in cm)			
<b>Standard size - 10cm height</b>			
APP10/CC/ _____		Positioner 10 with Comfair cover	£586
APP10/CI/ _____		Positioner 10 with Incotec cover	£586
(Specify width x depth in cm)			
<b>Non-standard size - 10cm height</b>			
APP10/CC/ _____		Positioner 10 with Comfair cover	£685
APP10/CI/ _____		Positioner 10 with Incotec cover	£685
(Specify width x depth in cm)			
<b>TOTAL PRICE:</b>			

**Special Instructions - Please supply the following information:**

**Name:**

**Email:**

**Phone:**



**Description of special request (please include relevant option code):**

Tel: 01656 776222 Fax: 01656 776220  
Email: ordersuk@invacare.com  
www.invacare.co.uk

Customer Name :	Account No :
Address :	Order No :
Tel Number :	Order Qty :
Delivery Address :	Order Date :

**Vicair Twin O2**  
Retail order form  
Max user weight 250kg (39 stone)

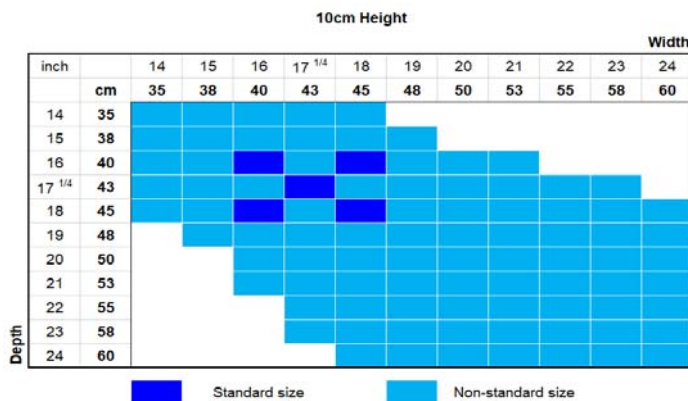
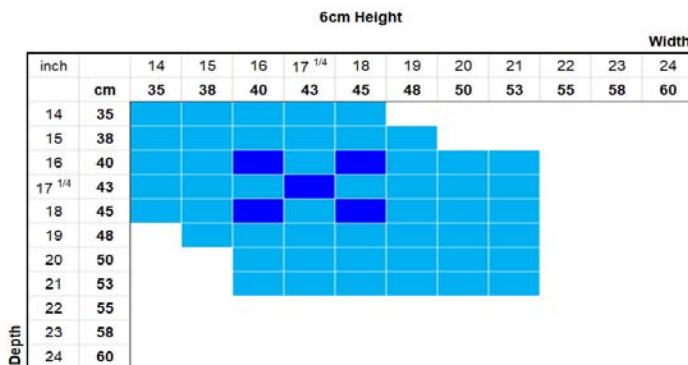

**Standard Features:**

- Divided into 2 compartments - front and rear
- Limits sliding while minimising shear forces
- Relatively flat cushion
- Suitable for wheelchair and community use
- Individually adjustable
- Allows immersion and optimal skin protection
- Choice of 6 or 10cm heights
- Perforated cushion offering breathability and moisture control
- Fully machine washable without the need to remove the SmartCells

Code	X	Description	Price
<b>Standard size - 6cm height</b>			
OTW6/TP/____		Twin 6 with 2x Top cover	£510
OTW6/CC/____		Twin 6 with Comfair cover	£510
OTW6/CI/____		Twin 6 with Incotec cover	£510
(Specify width x depth in cm)			
<b>Non-standard size - 6cm height</b>			
OTW6/TP/____		Twin 6 with 2x Top cover	£659
OTW6/CC/____		Twin 6 with Comfair cover	£659
OTW6/CI/____		Twin 6 with Incotec cover	£659
(Specify width x depth in cm)			
<b>Standard size - 10cm height</b>			
OTW10/TP/____		Twin 10 with 2x Top cover	£510
OTW10/CC/____		Twin 10 with Comfair cover	£510
OTW10/CI/____		Twin 10 with Incotec cover	£510
(Specify width x depth in cm)			
<b>Non-standard size - 10cm height</b>			
OTW10/TP/____		Twin 10 with 2x Top cover	£659
OTW10/CC/____		Twin 10 with Comfair cover	£659
OTW10/CI/____		Twin 10 with Incotec cover	£659
(Specify width x depth in cm)			
<b>TOTAL PRICE:</b>			

**Special Instructions - Please supply the following information:**

**Name:**

**Email:**

**Phone:**



**Description of special request (please include relevant option code):**

Tel: 01656 776222 Fax: 01656 776220  
Email: ordersuk@invacare.com  
www.invacare.co.uk

Customer Name :	Account No :
Address :	Order No :
Tel Number :	Order Qty :
Delivery Address :	Order Date :

**Vicair Adjuster O2**  
Retail order form  
Max user weight 250kg (39 stone)

**6cm Height**

		Width											
		14	15	16	17 1/4	18	19	20	21	22	23	24	
inch	cm	35	38	40	43	45	48	50	53	55	58	60	
14	35	[Standard size grid]											
15	38	[Standard size grid]											
16	40	[Standard size grid]											
17 1/4	43	[Standard size grid]											
18	45	[Standard size grid]											
19	48	[Standard size grid]											
20	50	[Standard size grid]											
21	53	[Standard size grid]											
22	55	[Standard size grid]											
23	58	[Standard size grid]											
24	60	[Standard size grid]											



**10cm Height**

		Width											
		14	15	16	17 1/4	18	19	20	21	22	23	24	
inch	cm	35	38	40	43	45	48	50	53	55	58	60	
14	35	[Standard size grid]											
15	38	[Standard size grid]											
16	40	[Standard size grid]											
17 1/4	43	[Standard size grid]											
18	45	[Standard size grid]											
19	48	[Standard size grid]											
20	50	[Standard size grid]											
21	53	[Standard size grid]											
22	55	[Standard size grid]											
23	58	[Standard size grid]											
24	60	[Standard size grid]											

[Blue square] Standard size

**Standard Features:**

- Optimal temperature and moisture regulation
- Fully machine washable
- Individual solution for asymmetry, even the extreme kinds
- Allows total immersion for equal pressure distribution
- Prevents sliding while minimizing shear
- 2 year warranty on inner cover with lifetime warranty on SmartCells

Standard sizes - 6cm height		
OAD6/TP/___	Adjuster O2 with 2x Top cover	£560
OAD6/CC/___	Adjuster O2 with Comfair cover	£560
OAD6/CI/___	Adjuster O2 with Incotec cover	£560
(Specify width x depth in cm)		
Standard sizes - 10cm height		
OAD10/TP/___	Adjuster O2 with 2x Top cover	£560
OAD10/CC/___	Adjuster O2 with Comfair cover	£560
OAD10/CI/___	Adjuster O2 with Incotec cover	£560
(Specify width, depth in cm)		
<b>TOTAL PRICE:</b>		

**Special Instructions - Please supply the following information:**

**Name:** \_\_\_\_\_ **Email:** \_\_\_\_\_ **Phone:** \_\_\_\_\_

**Description of special request (please include relevant option code):**

\_\_\_\_\_





Tel: 01656 776222 Fax: 01656 776220  
Email: ordersuk@invacare.com  
www.invacare.co.uk

Customer Name :	Account No :
Address :	Order No :
Tel Number :	Order Qty :
Delivery Address :	Order Date :

**Vicair Adjuster 12 O2**  
Retail order form  
Max user weight 250kg (39 stone)

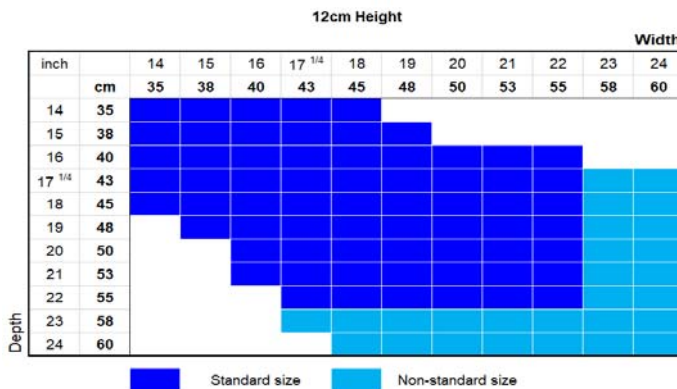

**Standard Features:**  
 Perfect support for the asymmetric body  
 Automatically manages small obliquities  
 Individually adjustable to support more extreme asymmetry  
 High level of comfort and optimal skin protection  
 12cm height for extra immersion and pressure distribution  
 Helps prevent sliding while minimising shear forces  
 Perforated cushion offering breathability and moisture control  
 Fully machine washable without the need to remove the SmartCells

Code	X	Description	Price
<b>Standard sizes</b>			
OAD12/TP/_____		Adjuster 12 O2 with 2x Top cover	£626
OAD12/CC/_____		Adjuster 12 O2 with Comfair cover	£626
OAD12/CI/_____		Adjuster 12 O2 with Incotec cover	£626
(Specify width x depth in cm)			
<b>Non-standard sizes</b>			
OAD12/TP/_____		Adjuster 12 O2 with 2x Top cover	£821
OAD12/CC/_____		Adjuster 12 O2 with Comfair cover	£821
OAD12/CI/_____		Adjuster 12 O2 with Incotec cover	£821
(Specify width x depth in cm)			

**TOTAL PRICE:**

**Special Instructions - Please supply the following information:**

**Name:** \_\_\_\_\_ **Email:** \_\_\_\_\_ **Phone:** \_\_\_\_\_

Description of special request (please include relevant option code):









Tel: 01656 776222 Fax: 01656 776220  
Email: ordersuk@invacare.com  
www.invacare.co.uk

Customer Name :	Account No :
Address :	Order No :
Tel Number :	Order Qty :
Delivery Address :	Order Date :

**Vicair Multifunctional O2**

Retail order form  
Max user weight 250kg (39 stone)



**Standard Features:**

- Developed for use in tilt-in-space wheelchairs with adjustable seat depth
- Based on the Adjuster O2 design with deep rear compartments
- Total immersion for equal pressure distribution
- Optimal skin protection and stability
- Redistributes pressure equally
- Pre-ischial bar helps prevent sliding forward
- 8cm height
- Choice of 4 sizes only
- Lifetime warranty on SmartCells
- Fully machine washable without removing SmartCells
- Perforated cushion for breathability



Code	X	Description			Price
<b>Cushion &amp; cover options</b>					
OMFS/TP/3752		Multifunctional O2 cushion with 2 x Top cover	37x52x8cm	14"x20"x3 1/4"	£656
OMFS/TP/4052		Multifunctional O2 cushion with 2 x Top cover	40x52x8cm	16x20"x3 1/4"	£656
OMFS/TP/4552		Multifunctional O2 cushion with 2 x Top cover	45x52x8cm	18x20"x3 1/4"	£656
OMFS/TP/5052		Multifunctional O2 cushion with 2 x Top cover	50x52x8cm	20x20"x3 1/4"	£656
OMFS/CC/3752		Multifunctional O2 cushion with Comfair cover	37x52x8cm	14"x20"x3 1/4"	£656
OMFS/CC/4052		Multifunctional O2 cushion with Comfair cover	40x52x8cm	16x20"x3 1/4"	£656
OMFS/CC/4552		Multifunctional O2 cushion with Comfair cover	45x52x8cm	18x20"x3 1/4"	£656
OMFS/CC/5052		Multifunctional O2 cushion with Comfair cover	50x52x8cm	20x20"x3 1/4"	£656
OMFS/CI/3752		Multifunctional O2 cushion with Incotec cover	37x52x8cm	14"x20"x3 1/4"	£656
OMFS/CI/4052		Multifunctional O2 cushion with Incotec cover	40x52x8cm	16x20"x3 1/4"	£656
OMFS/CI/4552		Multifunctional O2 cushion with Incotec cover	45x52x8cm	18x20"x3 1/4"	£656
OMFS/CI/5052		Multifunctional O2 cushion with Incotec cover	50x52x8cm	20x20"x3 1/4"	£656
<b>TOTAL PRICE:</b>					





Tel: 01656 776222 Fax: 01656 776220  
Email: ordersuk@invacare.com  
www.invacare.co.uk

Customer Name :	Account No :
Address :	Order No :
Tel Number :	Order Qty :
Delivery Address :	Order Date :

**Vicair Xxtra O2**  
Retail order form  
Max user weight 500kg (79 stone)

10cm Height



		Width					
		22	24	26	28	30	
Depth	inch						
	cm	55	60	65	70	75	
	18	45					
	20	50					
	22	55					
	24	60					
	26	65					
	28	70					
30	75						



Standard size     Non-standard size

**Standard Features:**

Based on Adjuster O2 design, especially developed for larger clients  
The compartments are filled with a bigger size of SmartCells  
Combines excellent stability and positioning possibilities with a very high level of comfort  
Accommodates pelvic obliquities and can be individually adjusted to support more extreme asymmetry  
Machine washable without the need to remove SmartCells  
Perforated cushion top with mesh underside offers breathability, temperature and moisture regulation  
10cm height

Code	X	Description	Price
<b>Standard sizes</b>			
OBA/TP/____		Xxtra O2 with 2x Top cover	£691
OBA/CC/____		Xxtra O2 with Comfair cover	£691
OBA/CI/____		Xxtra O2 with Incotec cover	£691
(Specify width x depth in cm)			
<b>Non-standard sizes</b>			
OBA/TP/____		Xxtra O2 with 2x Top cover	£890
OBA/CC/____		Xxtra O2 with Comfair cover	£890
OBA/CI/____		Xxtra O2 with Incotec cover	£890
(Specify width x depth in cm)			

**TOTAL PRICE:**

**Special Instructions - Please supply the following information:**

**Name:** \_\_\_\_\_ **Email:** \_\_\_\_\_ **Phone:** \_\_\_\_\_



Description of special request (please include relevant option code):



Tel: 01656 776222 Fax: 01656 776220  
Email: ordersuk@invacare.com  
www.invacare.co.uk

Customer Name :	Account No :
Address :	Order No :
Tel Number :	Order Qty :
Delivery Address :	Order Date :

**Vicair Pommel O2**  
Retail order form  
Max user weight 250kg (39 stone)

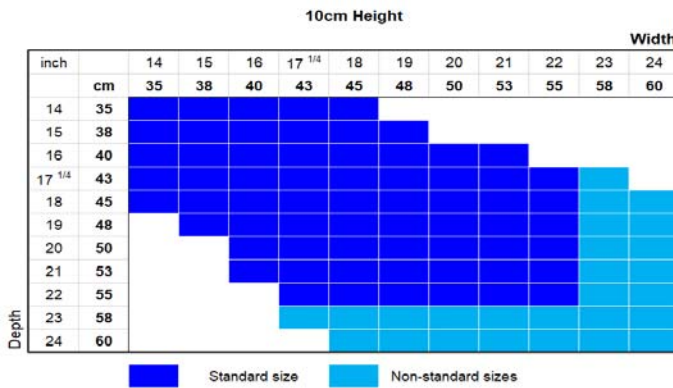

**Features**

Ideal for individuals presenting with adducted condition  
 Detachable pommel facilitates forward transfers and those who use urinal bottles  
 Cushion and pommel covered separately for ease of use  
 10cm height cushion with 20cm height pommel  
 Perforated cushion offering breathability and moisture control  
 Fully machine washable without the need to remove the SmartCells

NOTE: TOP COVER NOT AVAILABLE ON THIS CUSHION DESIGN

Standard sizes		
OPC10/CC/ _____	Pommel O2 cushion with Comfair cover	£699
OPC10/CI/ _____	Pommel O2 cushion with Incotec cover	£699
(Specify width x depth in cm)		
Non-standard sizes		
OPC10/CC/ _____	Pommel O2 cushion with Comfair cover	£872
OPC10/CI/ _____	Pommel O2 cushion with Incotec cover	£872
(Specify width, depth in cm)		

**TOTAL PRICE:**

**Special Instructions - Please supply the following information:**

**Name:** \_\_\_\_\_ **Email:** \_\_\_\_\_ **Phone:** \_\_\_\_\_



**Description of special request (please include relevant option code):**





Yes, you can.®

Tel: 01656 776222 Fax: 01656 776220

Email: ordersuk@invacare.com

www.invacare.co.uk

Customer Name :	Account No :
Address :	Order No :
Tel Number :	Order Qty :
Delivery Address :	Order Date :

### Vicair Centre Relief O2

Retail order form  
Max user weight 250kg (39 stone)

10cm Height

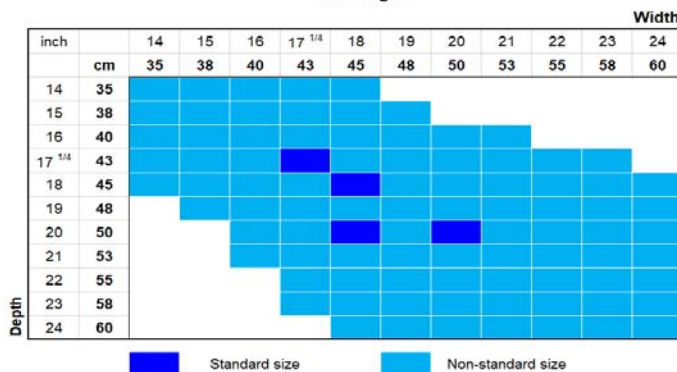

**Standard Features:**

- For offloading the rectal area
- High support
- Individually adjustable compartments
- Lifetime warranty on SmartCells
- Fully machine washable without removing SmartCells
- Perforated cushion for breathability
- 10cm height

Code	X	Description	Price
<b>Standard sizes</b>			
OCR/TP/_____		Centre Relief O2 with 2 x Top cover	£674
OCR/CC/_____		Centre Relief O2 with Comfair cover	£674
OCR/CI/_____		Centre Relief O2 with Incotec cover	£674
(Specify width, depth in cm)			
<b>Non-standard sizes</b>			
OCR/TP/_____		Centre Relief O2 with 2 x Top cover	£738
OCR/CC/_____		Centre Relief O2 with Comfair cover	£738
OCR/CI/_____		Centre Relief O2 with Incotec cover	£738
(Specify width, depth in cm)			

**TOTAL PRICE:**

**Special Instructions - Please supply the following information:**

Name: \_\_\_\_\_ Email: \_\_\_\_\_ Phone: \_\_\_\_\_



Description of special request (please include relevant option code):





Tel: 01656 776222 Fax: 01656 776220  
Email: ordersuk@invacare.com  
www.invacare.co.uk

Customer Name :	Account No :
Address :	Order No :
Tel Number :	Order Qty :
Delivery Address :	Order Date :

**Vicair Vector O2**  
Retail order form  
Max user weight 250kg (39 stone)

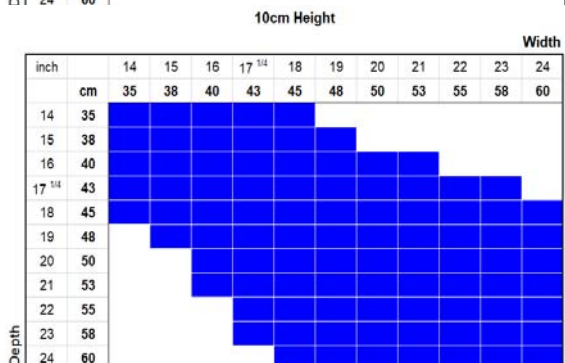
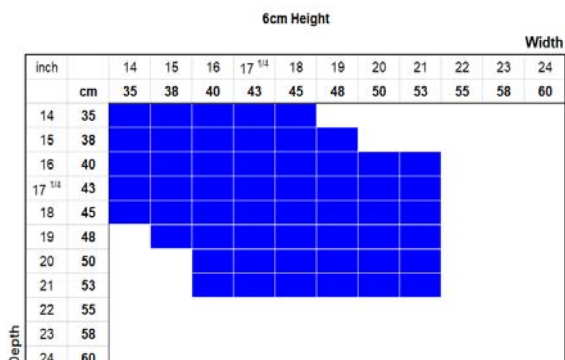

Standard size

**Standard Features:**

- Machine washable - no need to empty cells!
- Ischial well - Two compartments for superior offloading of the IT-coccyx area & extra positioning possibilities
- Trochanter support: firmer density to provide lateral stability and to redistribute pressure to help create an ischial well
- Front compartments provide leg alignment and stability. Easily adjustable for individual positioning needs.
- Mid height zip closure for easy adjustment when client is seated, and to increase cushion immersion. (Boxing Effect)
- Choice of 6 or 10cm heights

Code	X	Description	Price
<b>Standard size - 6cm height</b>			
OVR6/TP/____		O2 Vector 6 with 2x Top Cover	£568
OVR6/CC/____		O2 Vector 6 with Comfair cover	£568
OVR6/CI/____		O2 Vector 6 with Incotec cover	£568
(Specify width x depth in cm)			
<b>Standard size - 10cm height</b>			
OVR10/TP/____		O2 Vector 10 with 2x Top Cover	£568
OVR10/CC/____		O2 Vector 10 with Comfair cover	£568
OVR10/CI/____		O2 Vector 10 with Incotec cover	£568
(Specify width x depth in cm)			

TOTAL PRICE:

**Special Instructions - Please supply the following information:**

Name: \_\_\_\_\_ Email: \_\_\_\_\_ Phone: \_\_\_\_\_



Description of special request (please include relevant option code):



Tel: 01656 776222 Fax: 01656 776220  
Email: ordersuk@invacare.com  
www.invacare.co.uk

Vicair Vector Junior O2  
**April 2020**

Customer Name :	Account No :
Address :	Order No :
Tel Number :	Order Qty :
Delivery Address :	Order Date :

**Vicair Vector Junior O2**

Retail order form  
Max user weight 100 kg (16 stone)

9cm Height



		Width				
inch		10	11	12	13	14
cm		25	28	30	33	35
Depth	10					
	11					
	12					
	13					
	14					

Standard size
  Non-standard size



**Standard Features:**

Vector O2 cushion especially designed for children  
Firmer density for positioning and lateral stability  
Two angled outer rear compartments for offloading to trochanters  
9cm height  
Filled with small-sized SmartCells for optimal pressure redistribution  
Lifetime warranty on Smartcells  
Fully machine washable without the need to remove SmartCells

Code	X	Description	Price
<b>Standard sizes</b>			
OJVR/TP/____		Vector Junior O2 with 2 x Top cover	£482
OJVR/CC/____		Vector Junior O2 with Comfair cover	£482
OJVR/CI/____		Vector Junior O2 with Incontinence cover	£482
(Specify width x depth in cm)			
<b>Non-standard sizes</b>			
OJVR/TP/____		Vector Junior O2 with 2 x Top cover	£482
OJVR/CC/____		Vector Junior O2 with Comfair cover	£482
OJVR/CI/____		Vector Junior O2 with Incontinence cover	£482
(Specify width x depth in cm)			

**TOTAL PRICE:**

**Special Instructions - Please supply the following information:**

**Name:** \_\_\_\_\_ **Email:** \_\_\_\_\_ **Phone:** \_\_\_\_\_



**Description of special request (please include relevant option code):**





Yes, you can.®

Tel: 01656 776222 Fax: 01656 776220  
 Email: ordersuk@invacare.com  
 www.invacare.co.uk

Vicair Active O2 cushion  
 April 2020

Customer Name :	Account No :
Address :	Order No :
Tel Number :	Order Qty :
Delivery Address :	Order Date :

**Vicair Active O2**  
 Retail order form  
 Max user weight 200 kg (31 stone)

6cm Height



		Width										
		14	15	16	17 1/4	18	19	20	21	22	23	24
inch	cm	35	38	40	43	45	48	50	53	55	58	60
14	35											
15	38											
16	40											
17 1/4	43											
18	45											
19	48											
20	50											
21	53											
22	55											
23	58											
24	60											



9cm Height

		Width										
		14	15	16	17 1/4	18	19	20	21	22	23	24
inch	cm	35	38	40	43	45	48	50	53	55	58	60
14	35											
15	38											
16	40											
17 1/4	43											
18	45											
19	48											
20	50											
21	53											
22	55											
23	58											
24	60											

Standard size

**Standard Features:**

Ideal for individuals using active wheelchairs  
 Ergonomically shaped firm foam front for easy transfers  
 Vicair SmartCells in rear (junior cells in the 6cm, standard in the 9cm)  
 Two compartments for superior offloading of the IT-coccyx area & extra positioning possibilities  
 Trochanter support: firmer density to provide lateral stability and to redistribute pressure to help create an ischial well  
 Available in 6 and 9cm heights

Code	X	Description	Price
<b>Standard sizes - 6cm height</b>			
OCT6/____		Active O2 with integrated cover	£510
(Specify width x depth in cm)			
<b>Standard sizes - 9cm height</b>			
OCT9/____		Active O2 with integrated cover	£510
(Specify width x depth in cm)			

**TOTAL PRICE:**

**Special Instructions - Please supply the following information:**

**Name:** \_\_\_\_\_ **Email:** \_\_\_\_\_ **Phone:** \_\_\_\_\_

Description of special request (please include relevant option code):







Yes, you can.®

Tel: 01656 776222 Fax: 01656 776220

Email: ordersuk@invacare.com

www.invacare.co.uk

Vicair Allrounder O2

April 2020

Customer Name :	Account No :
Address :	Order No :
Tel Number :	Order Qty :
Delivery Address :	Order Date :

**Vicair Allrounder O2**  
A valuable option for your sports activities  
Max user weight 100kg (16 stone)

CUSHION SIZE	
Small	< 38 cm
Medium	38 – 42,5 cm
Large	43 – 48 cm

Measure the width of your client's hips to check which size matches the size of their body. When seated, hold a tape measure horizontally above the widest point of the upper legs, closely against the front of their hips. Do not follow the leg contours, keep the tape measure straight. Measure from A to B (or B to A). Choose the larger size if the measured size is in between two sizes.



**Standard Features:**

Ergonomically shaped back part for seamless fit to the shape of the lower back.  
Vicair SmartCells for skin-protection  
Easily adjustable straps to provide comfort and follow the body  
Stays with your client during activities and transfers  
Extremely light to support optimal mobility

Code	X	Description			Price
<b>Cushion &amp; cover options</b>					
OAL/SMALL		Small Allrounder O2	< 38 cm	< 15"	£437
OAL/MEDIUM		Medium Allrounder O2	38-42,5cm	15-16¼"	£437
OAL/LARGE		Large Allrounder O2	42-48cm	17¼-19"	£437
<b>TOTAL PRICE:</b>					

**Special Instructions - Please supply the following information:**

Name:

Email:

Phone:



Description of special request (please include relevant option code):







Tel: 01656 776222 Fax: 01656 776220  
Email: ordersuk@invacare.com  
www.invacare.co.uk

Customer Name :	Account No :
Address :	Order No :
Tel Number :	Order Qty :
Delivery Address :	Order Date :

**Vicair Asymmetric O2 (custom made)**  
Retail order form

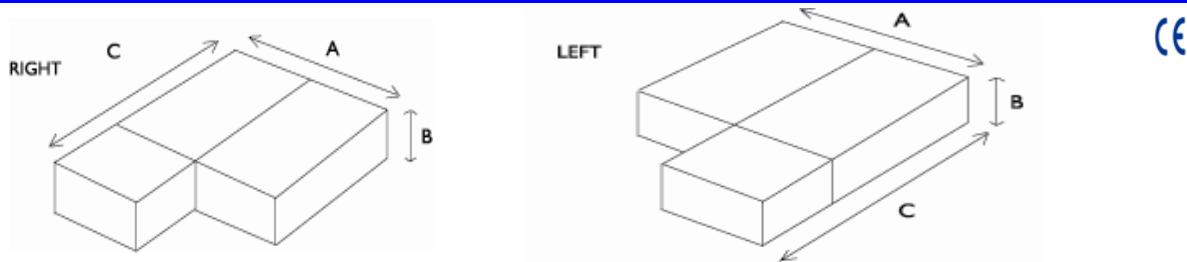

**Standard Features:**  
For accommodating extreme body asymmetry  
Available with either one left or one right front compartment.  
Cushion height: 10 cm / 4 " (B)

A= Width  
C= Depth (total depth is divided in 1/3 front and 2/3 rear)

Code	X	Description	Price
<b>Standard sizes</b>			
OACL10/CC/ ____		Asymmetric left with Comfair cover	Custom made (special) Request
OACL10/CI/ ____		Asymmetric left with Incontinence cover	Custom made (special) Request
(Specify cushion width x depth)			<b>TOTAL PRICE:</b>

**Special Instructions - Please supply the following information:**

Name: \_\_\_\_\_ Email: \_\_\_\_\_ Phone: \_\_\_\_\_

Description of special request (please include relevant option code):





Yes, you can.

Tel: 01656 776222 Fax: 01656 776220  
 Email: ordersuk@invacare.com  
 www.invacare.co.uk

**Vicair SmartCells**

Code	Description	Price
00400009	Small SmartCells (pack of 50) for Active 6, Active 6 O2, Allrounder, Allrounder O2, Junior Vector, Junior Vector O2	£37
SC-bag	Standard SmartCells (pack of 50) for Active 9, Active 9 O2, Adjuster, Adjuster O2, Centre Relief, Centre Relief O2, Multifunctional cushion, Multifunctional O2 cushion, Positioner, Twin, Twin O2, Vector, Vector O2	£37
00400008	Large SmartCells (pack of 50) for Xxtra, Xxtra O2	£37

**Vicair Active spares**

Code	Description	Price
<b>Replacement cover options</b>		
ACTCV6/ _____	Cover for Active 6	£206
ACTCV9/ _____	Cover for Active 9	£206

(Specify width x depth in cm)



**Spare parts - Foam inlay (A)**

FI6/ _____	Foam inlay for Active 6	£168
FI9/ _____	Foam inlay for Active 9	£168

(Specify cushion width x depth in cm)

**Spare parts - SmartCell liner left (B)**

SCL6/ _____	Smartcell liner left for Active 6	£88
SCL9/ _____	Smartcell liner left for Active 9	£88

(Specify cushion width x depth in cm)

**Spare parts - SmartCell liner right (C)**

SCR6/ _____	Smartcell liner right for Active 6	£88
SCR9/ _____	Smartcell liner right for Active 9	£88

(Specify cushion width x depth in cm)

**Spare parts - SmartCell liner middle (D)**

SCM6/ _____	Smartcell liner middle for Active 6	£88
SCM9/ _____	Smartcell liner middle for Active 6	£88

(Specify cushion width x depth in cm)

**Vicair Active O2 spares**

Code	Description	Price
<b>Replacement covers (C)</b>		
OCTCV6/ _____	Cover for Active 6 O2	£149
OCTCV9/ _____	Cover for Active 9 O2	£149

(Specify cushion width x depth in cm)



**Spare parts - Foam inlay (A)**

FI6/ _____	Foam inlay for Active 6 O2	£173
FI9/ _____	Foam inlay for Active 6 O2	£173

(Specify cushion width x depth in cm)

**Foam liner (B)**

OSCF6/ _____	Foam liner for Active 6 O2	£53
OSCF9/ _____	Foam liner for Active 6 O2	£53

(Specify cushion width x depth in cm)

**Spare parts - SmartCell liner right (D)**

OSCLL6/ _____	SmartCell liner left for Active 6 O2	£91
OSCLL9/ _____	SmartCell liner left for Active 9 O2	£91

(Specify cushion width x depth in cm)

Spare parts - SmartCell liner middle right (E)			
OSCLR6/ _____		SmartCell liner right for Active 6 O2	£91
OSCLR9/ _____		SmartCell liner right for Active 9 O2	£91
(Specify cushion width x depth in cm)			
Spare parts - SmartCell liner middle left (F)			
OSCMR6/ _____		SmartCell liner middle right for Active 6 O2	£91
OSCMR9/ _____		SmartCell liner middle right for Active 9 O2	£91
(Specify cushion width x depth in cm)			
Spare parts - SmartCell liner left (G)			
OSCML6/ _____		SmartCell liner middle left for Active 6 O2	£91
OSCML9/ _____		SmartCell liner middle left for Active 9 O2	£91
(Specify cushion width x depth in cm)			

## Vicair Adjuster 12 / Adjuster 12 O2 spares

Code	Description	Price
OCV12/TP/ _____	Top Cover for Adjuster 12 O2	£112
VCC12/ _____	Comfair Cover for Adjuster 12 / Adjuster 12 O2	£112
VC12/ _____	Incotec Cover for Adjuster 12 / Adjuster 12 O2	£112

## Vicair Adjuster/Adjuster O2 spares

Code	Description	Price
OCV6/TP/ _____	Top cover for Adjuster 6 O2	£83
VCC6/ _____	Comfair Cover for Adjuster 6 / Adjuster 6 O2	£83
VC16/ _____	Incotec Cover for Adjuster 6 / Adjuster 6 O2	£83
OCV10/TP/ _____	Top cover for O2 Adjuster 10 O2	£83
VCC10/ _____	Comfair Cover for Adjuster 10 / Adjuster 10 O2	£83
VC10/ _____	Incotec Cover for Adjuster 10 / Adjuster 10 O2	£83
(Specify cushion width x depth in cm)		

## Vicair AllRounder O2 spares

Code	Description	Price
OALH/SMALL	O2 AllRounder harness base small < 38cm < 15"	£280
OALH/MEDIUM	O2 AllRounder harness base medium 38-42,5cm 15-16¾"	£280
OALH/LARGE	O2 AllRounder harness base large 42-48cm 17¼-19"	£280
OALC/SMALL	O2 AllRounder cushion small < 38cm < 15"	£157
OALC/MEDIUM	O2 AllRounder cushion medium 38-42,5cm 15-16¾"	£157
OALC/LARGE	O2 AllRounder cushion large 42-48cm 17¼-19"	£157
(Specify cushion width x depth in cm)		

## Vicair Butterfly spares

Code	Description	Price
ABUCV/CK/ _____	Comfair cover for Butterfly	£66
(Specify cushion width x depth in cm)		

## Vicair Centre Relief / Centre Relief O2 spares

Code	Description	Price
OCV10/TP/ _____	Comfair cover for Centre Relief O2	£83
VCC10/ _____	Comfair cover for Centre Relief / Centre Relief O2	£83
VC10/ _____	Incotec cover for Centre Relief / Centre Relief O2	£83
(Specify cushion width x depth in cm)		

## Vicair Liberty spares

Code	Description	Price
LBACV/CK/ _____	Comfair cover for Liberty cushion	£58
LBACV/IN/ _____	Incotec cover for Liberty cushion	£58
(Specify cushion width x depth in cm)		

## Vicair Multifunctional / Multifunctional O2 cushion spares

Code	Description	Price
OMFSCV/TP/ _____	Top cover for Multifunctional / Multifunctional O2 cushion	£93
OMFSCV/CC/ _____	Comfair cover for Multifunctional / Multifunctional O2 cushion	£93
OMFSCV/CI/ _____	Incotec cover for Multifunctional / Multifunctional O2 cushion	£93
(Specify cushion width x depth in cm)		

## Vicair Positioner cushion spares

Code	Description	Price
VCC6/ ____	Comfair cover for Positioner 6	£83
VCI6/ ____	Incotec cover for Positioner 6	£83
VCC10/ ____	Comfair cover for Positioner 10	£83
VCI10/ ____	Incotec cover for Positioner 10	£83

(Specify cushion width x depth in cm)

## Vicair Twin / Twin O2 spares

Code	Description	Price
OCV6/TP/ ____	Top cover for Twin 6 O2	£83
VCC6/ ____	Comfair cover for Twin 6 / Twin 6 O2	£83
VCI6/ ____	Incotec cover for Twin 6 / Twin 6 O2	£83
OCV10/TP/ ____	Top cover for Twin 10 O2	£83
VCC10/ ____	Comfair cover for Twin 10 / Twin 10 O2	£83
VCI10/ ____	Incotec cover for Twin 10 / Twin 10 O2	£83

(Specify cushion width x depth in cm)

## Vicair Vector / Vector O2 spares

Code	Description	Price
OCV6/TP/ ____	O2 Top Cover for Vector 6 O2	£83
VCC6/ ____	Comfair cover for Vector 6 / Vector 6 O2	£83
VCI6/ ____	Incotec cover for Vector 6 / Vector 6 O2	£83
OCV10/TP/ ____	O2 Top Cover for Vector 10 O2	£83
VCC10/ ____	Comfair cover for Vector 10 / Vector 10 O2	£83
VCI10/ ____	Incotec cover for Vector 10 / Vector 10 O2	£83

(Specify cushion width x depth in cm)

## Vicair Junior Vector / Junior Vector O2 spares

Code	Description	Price
OJVRV/TP/ ____	Comfair cover for Junior Vector O2	£83
OJVRV/CC/ ____	Comfair cover for Junior Vector / Junior Vector O2	£83
OJVRV/CI/ ____	Incotec cover for Junior Vector / Junior Vector O2	£83

(Specify cushion width x depth in cm)

## Vicair Xtra / Xtra O2 spares

Code	Description	Price
OBACV/TP/ ____	Top cover for Xtra O2	£112
OBACV/CC/ ____	Comfair cover for Xtra / Xtra O2	£112
OBACV/CI/ ____	Incotec cover for Xtra / Xtra O2	£112

(Specify cushion width x depth in cm)

## Vicair Anatomic spares

Code	Description	Price
AABCV/AX/ ____	Air exchange cover for anatomic back	£107

(Specify cushion width x height in cm)

## Vicair Flex Back spares

Code	Description	Price
00600026	AFB Side support (each)	£24
AFBCV/AX/ ____	Flex Back spare cover	£91

(Specify cushion width x height in cm)

## Vicair Liberty back spares

Code	Description	36-40cm	14¼-16"	Price
LBCCV/CK/1	Comfair cover for Liberty back (35x32cm)	36-40cm	14¼-16"	£162
LBCCV/CK/2	Comfair cover for Liberty back (40x32cm)	40-44cm	16-17½"	£162
LBCCV/CK/3	Comfair cover for Liberty back (40x40cm)	44-48cm	17½-19"	£162

## Vicair Multifunctional back / Multifunctional O2 back spares

Code	Description	36x45cm	14½x18"	Price
OMFBCV/CC/ ____	Comfair cover for Multifunctional back	36x45cm	14½x18"	£88

(Specify cushion width x height in cm)





Yes, you can.®

Tel: 01656 776222 Fax: 01656 776220

Email: ordersuk@invacare.com

www.invacare.co.uk

Vicair Butterfly  
April 2020

Customer Name :	Account No :
Address :	Order No :
Tel Number :	Order Qty :
Delivery Address :	Order Date :

### Vicair Butterfly

Retail order form

Fills the space between the back of the wheelchair and the contours of the body

**Standard Features:**

- Consists of three compartments
- Can be adjusted to support asymmetrical deformities
- Supports the pelvis and lower spinal column
- Improves lateral support
- Can combine two Butterfly Backs
- Choice of 3 sizes



Code	X	Description			Price
<b>Cushion &amp; cover options</b>					
ABU/CK/4020		Butterfly with Comfair cover	40x20cm	16x8"	£222
ABU/CK/4520		Butterfly with Comfair cover	45x20cm	18x8"	£222
ABU/CK/5020		Butterfly with Comfair cover	50x20cm	20x8"	£222
<b>TOTAL PRICE:</b>					

**Special Instructions - Please supply the following information:**



Name: \_\_\_\_\_ Email: \_\_\_\_\_ Phone: \_\_\_\_\_

Description of special request (please include relevant option code):







Yes, you can.

Tel: 01656 776222 Fax: 01656 776220

Email: ordersuk@invacare.com

www.invacare.co.uk

RETAIL PRESCRIPTION FORM

Vicair Liberty back  
April 2020

Customer Name :	Account No :
Address :	Order No :
Tel Number :	Order Qty :
Delivery Address :	Order Date :

**Vicair Liberty back**  
Retail order form  
Max user weight 150 kg (23 stone)

**CUSHION SIZES**

Available in 3 sizes. Mentioned cm/inches are the min-max distance between the back posts of the wheelchair.

	cm	inches
LBS/1	36-40	14¼ - 16
LBS/2	40-44	16 - 17½
LBS/3	44-48	17½ - 19



**Standard features:**  
Simple positioning and for comfort  
Easy to apply on a folding wheelchair  
Automatically adapts to change, including reclining back support  
Excellent for users with back pain

Code	X	Description			Price
<b>Liberty cushion with tension adjustable back</b>					
LBS/1		Liberty back system 1	36-40cm	14¼-16"	£437
LBS/2		Liberty back system 2	40-44cm	16-17½"	£437
LBS/3		Liberty back system 3	44-48cm	17½-19"	£437
<b>Liberty back cushion</b>					
LBC/CK/1		Liberty back cushion 1	36-40cm	14¼-16"	£296
LBC/CK/2		Liberty back cushion 2	40-44cm	16-17½"	£296
LBC/CK/3		Liberty back cushion 3	44-48cm	17½-19"	£296
<b>Tension adjustable back</b>					
SB/0232		Strap back for use with LBS 1	35-40cm	14-16"	£173
SB/0432		Strap back for use with LBS 2	40-45cm	16-18"	£173
SB/0332		Strap back for use with LBS 3	45-50cm	18-20"	£173
<b>TOTAL PRICE:</b>					

**Special Instructions - Please supply the following information:**

**Name:**

**Email:**

**Phone:**



Description of special request (please include relevant option code):



Tel: 01656 776222 Fax: 01656 776220  
Email: ordersuk@invacare.com  
www.invacare.co.uk

Customer Name :	Account No :
Address :	Order No :
Tel Number :	Order Qty :
Delivery Address :	Order Date :

**Vicair Anatomic Back**  
Retail order form  
Max user weight 150 kg (23 stone)

		Width					
		12	14	16	18	20	
		cm	30	35	40	45	50
Height	12¾	32					
	16	40					
	19¼	48					
	22½	56					

Standard size
  Non-standard size



**Standard Features:**

For use with tension adjustable back  
SmartCell-compartments for pressure redistribution and positioning  
Central compartment for offloading spinal cord  
Combine with easy-install adjustable Vicair Strap back for positioning and balance

Code	X	Description	Price
<b>Anatomic cushion &amp; cover</b>			
AABC/AX/____		Anatomic back cushion with Air exchange cover	Standard size £643
AABC/AX/____		Anatomic back cushion with Air exchange cover	Non-standard size £898
(Specify width x height in cm)			
<b>Anatomic cushion with tension adjustable back</b>			
AABS/AX/____		Anatomic back with Air exchange cover and strap back	Standard size £800
AABS/AX/____		Anatomic back with Air exchange cover and strap back	Non-standard size £1,054
(Specify width x height in cm)			
<b>Tension adjustable back only</b>			
SB/0232		Strap back	35-40cm 14-16" £173
SB/0332		Strap back	45-50cm 18-20" £173
SB/0240		Strap back	35-40cm 14-16" £173
SB/0340		Strap back	45-50cm 18-20" £173
SB/0248		Strap back	35-40cm 14-16" £173
SB/0348		Strap back	45-50cm 18-20" £173
SB/0256		Strap back	35-40cm 14-16" £173
SB/0356		Strap back	45-50cm 18-20" £173

**TOTAL PRICE:**

**Special Instructions - Please supply the following information:**

Name: \_\_\_\_\_ Email: \_\_\_\_\_ Phone: \_\_\_\_\_



Description of special request (please include relevant option code):





Tel: 01656 776222 Fax: 01656 776220  
Email: ordersuk@invacare.com  
www.invacare.co.uk

Customer Name :	Account No :
Address :	Order No :
Tel Number :	Order Qty :
Delivery Address :	Order Date :

**Vicair Multifunctional O2 Back**  
Retail order forms  
Max user weight 150 kg (23 stone)

		Width												
		14	14½	16	16½	17½	18	18½	19	20	21½	22½	24	
Height	inch	14¼	15	16	17¼	18	19	20	21	22	23	24	25	
	cm	36	37	40	41	43	45	46	48	50	54	58	60	
	14¼	36												
	15	38												
	16	40												
	17¼	43												
	18	45												
	19	48												
	20	50												
	21	52												
21½	54													
22½	58													
24	60													

Standard size
  Non-standard size



**Standard Features:**  
 Allround positioning, support and skin protection  
 Top compartments support the shoulders  
 Compartment shape provides freedom of movement  
 Side compartments  
 Total immersion and support  
 Supporting the spine offloading if required  
 Bottom compartment adjustable for sacral or lumbar support

Code	X	Description	Price
<b>Standard sizes</b>			
OMFB/CC/_____		Multifunctional O2 back cushion with Comfair cover	£651
(Specify width x height in cm)			
<b>Non-standard sizes</b>			
OMFB/CC/_____		Multifunctional O2 back cushion with Comfair cover	£779
(Specify width x height in cm)			
<b>TOTAL PRICE:</b>			

**Special Instructions - Please supply the following information:**

**Name:** \_\_\_\_\_ **Email:** \_\_\_\_\_ **Phone:** \_\_\_\_\_



Description of special request (please include relevant option code):





Yes, you can.®

Tel: 01656 776222 Fax: 01656 776220  
 Email: ordersuk@invacare.com  
 www.invacare.co.uk

Vicair Flex Back  
 April 2020

Customer Name :	Account No :
Address :	Order No :
Tel Number :	Order Qty :
Delivery Address :	Order Date :

**Vicair Flex Back**  
 Retail order form  
 Max user weight 150kg (23 stone)

		Width					
		16½	17¼	18	18¾	19½	
		cm	41	43	45	47	49
Height	22	55					
	22½	56					
	22¾	57					
	23¼	58					
	23½	59					
	24	60					

Standard size    
  Non-standard size



**Standard Features:**  
 Designed exclusively for use within the Rea Azalea Flex 3 & Modulite™  
 Equal pressure distribution & perfect support for the asymmetric body  
 Provides support and pressure ulcer prevention  
 Easily installed by securing the back cushion to the board using the hook and loop provided  
 Highly adaptable  
 Adjusted to suit individual positioning & pressure requirements

Code	X	Description	Price
<b>Standard sizes</b>			
AFB/AX/_____		Flex Back with Air exchange cover	£742
(Specify width x depth in cm)			
<b>Non-standard sizes</b>			
AFB/AX/_____		Flex Back with Air exchange cover	£742
(Specify width x depth in cm)			
<b>Accessories</b>			
00600026		AFB side support	£24
<b>TOTAL PRICE:</b>			

**Special Instructions - Please supply the following information:**

**Name:** \_\_\_\_\_ **Email:** \_\_\_\_\_ **Phone:** \_\_\_\_\_

Description of special request (please include relevant option code):







Tel: 01656 776222 Fax: 01656 776220  
Email: ordersuk@invacare.com  
www.invacare.co.uk

Matrx Flo-tech back support  
**April 2020**

<b>Account Name :</b>	<b>Account No :</b>
<b>Address :</b>	<b>Order No :</b>
<b>Tel No:</b>	<b>Order Qty :</b>
<b>Delivery address :</b>	<b>Order Date :</b>

## Matrx Flotech Back Support

Retail order form  
Maximum user weight 26 stone (165kg)

The *Matrx Flo-tech Back Support* provides a high degree of stability and provides improved posture resulting in enhanced protection from pressure ulcer development.

- Moisture resistant and vapour permeable cover
- Easily fixed to armchair or wheelchair with extendable straps
- Built in lumbar option available for increased protection
- One common size available

**Back Support Dimensions:**

- (A) Outside Width 43cm
- (B) Inside Width 36cm
- (C) Height 46cm
- (D) Depth 10cm

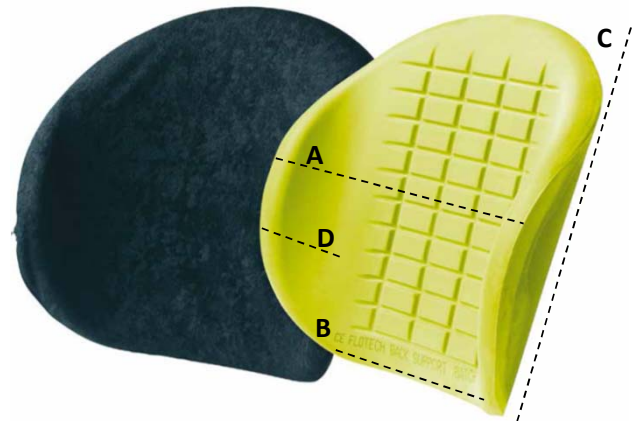

Code	X	Description	Price
------	---	-------------	-------

**Back supports**



Back support



Back support with lumbar



Back support with lumbar and handle



Lumbar pad

FBB1		Back support	Black Smooth (ingress resistant) cover	£155
FBB1/LUM		Back support with lumbar	Black Smooth (ingress resistant) cover	£170
FBB1/LUM/Handle		Back support with lumbar and handle	Black Smooth (ingress resistant) cover	£171
1538975		Back support	Spacer fabric cover	£158
LUMPAD/VIS		Lumbar pad		£43
FBB1B		Spare smooth cover		£50

**Special Instructions - Please supply the following information:**



**Name:**

**Email:**

**Phone:**

**Description of special request (please include relevant option code):**



Yes, you can.®

Tel: 01656 776222 Fax: 01656 776220  
 Email: ordersuk@invacare.com  
 www.invacare.co.uk

Matrx MX2 Back  
 April 2020

<b>Account Name :</b>	<b>Account No :</b>
<b>Address :</b>	<b>Order No :</b>
<b>Tel No:</b>	<b>Order Qty :</b>
<b>Delivery address :</b>	<b>Order Date :</b>

**Matrx MX2**  
**Retail order form**  
 Max.user weight: 113kg / 17 stone



		WIDTH				
mm		355	380	405	430	455
inch		14	15	16	17	18
HEIGHT	150	6				
	230	9				
	310	12				
	410	16				



**Standard Features:**  
 Lightweight carbon-fibre back shell  
 Anatomical contouring with 76 mm depth for enhanced lateral stability  
 Angle and depth adjustable  
 Cutouts for breathability to help manage microclimate  
 Slotted design to allow height adjustments even when in the chair  
 Breathable Spacer cover  
 Backrests 230mm or higher come with leatherette side panels  
 Oversized foam for enhanced comfort and protection  
 Hardware not included

Code	X	Description	Price
<b>MX2 Back shell</b>			
1629002		MX2 Back (35.5w x 15h)	14x6" £568
1629003		MX2 Back (35.5w x 23h)	14x9" £568
1629004		MX2 Back (35.5w x 31h)	14x12" £568
1629005		MX2 Back (35.5w x 41h)	14x16" £568
1629006		MX2 Back (38w x 15h)	15x6" £568
1629007		MX2 Back (38w x 23h)	15x9" £568
1629008		MX2 Back (38w x 31h)	15x12" £568
1629009		MX2 Back (38w x 41h)	15x16" £568
1629010		MX2 Back (40.5w x 15h)	16x6" £568
1629011		MX2 Back (40.5w x 23h)	16x9" £568
1629012		MX2 Back (40.5w x 31h)	16x12" £568
1629013		MX2 Back (40.5w x 41h)	16x16" £568
1629014		MX2 Back (43w x 15h)	17x6" £568
1629015		MX2 Back (43w x 23h)	17x9" £568

Order No :  
 Customer Ref :

MX2  
 1 of 2

Subject to Invacare's standard Terms and Conditions.  
 Invacare reserve the right to alter product specification without prior notice.

1629016	MX2 Back (43w x 31h)	17x12"	£568
1629017	MX2 Back (43w x 41h)	17x16"	£568
1629018	MX2 Back (45.5w x 15h)	18x6"	£568
1629019	MX2 Back (45.5w x 23h)	18x9"	£568
1629020	MX2 Back (45.5w x 31h)	18x12"	£568
1629021	MX2 Back (45.5w x 41h)	18x16"	£568

**Hardware**

Hardware is width-adjustable allowing the backrest to be fitted to wheelchairs that are up to 25mm narrower or wider than the actual backrest width for a precise fit and positioning in rigid or foldable wheelchairs with backrest tube diameter of 19 mm, 22 mm and 25 mm.



Fixed hardware



Mini set hardware

1629027	Fixed carbon fibre hardware		£189
1629028	Mini set (quick release) hardware		£256

**Privacy flap**

1551799	Extra Small	Fits 35.5cm width back	£53
1551800	Small	Fits 40.5cm width back	£53
1551903	Medium	Fits 43 and 45.5cm width back	£53

Special Instructions - Extended lead times will apply



Name:

Email:

Phone:

Description of special request (please include relevant option code):

Tel: 01656 776222 Fax: 01656 776220  
Email: ordersuk@invacare.com  
www.invacare.co.uk

Matrx Mini Series  
April 2020



<b>Account Name :</b>	<b>Account No :</b>
<b>Address :</b>	<b>Order No :</b>
<b>Tel No:</b>	<b>Order Qty :</b>
<b>Delivery address :</b>	<b>Order Date :</b>

**Matrx Mini back**  
Retail order form  
For paediatric applications

**Standard Features:**

Lightweight, contoured and durable backrest  
Adjustable mounting pins allow it to fit chairs with the same or 25mm wider  
Mini set hardware for easy installation and quick release with 100mm of depth adjustment, recline up to 30° and rotate  
Hardware fits 25, 22 & 19mm diameter back canes with included shims  
Choice of additional positioning options  
Water resistant and breathable covers with Kidabra print



Code	X	Description	Price
<b>Matrx Mini Back</b>			
MINI1007	Mini Back with Kidabra print inc. Mini Set hardware	26Wx18H cm 10x07"	£602
MINI1010	Mini Back with Kidabra print inc. Mini Set hardware	26Wx26H cm 10x10"	£602
MINI1012	Mini Back with Kidabra print inc. Mini Set hardware	26Wx31H cm 10x12"	£602
MINI1107	Mini Back with Kidabra print inc. Mini Set hardware	28Wx18H cm 11x07"	£602
MINI1110	Mini Back with Kidabra print inc. Mini Set hardware	28Wx26H cm 11x10"	£602
MINI1112	Mini Back with Kidabra print inc. Mini Set hardware	28Wx31H cm 11x12"	£602
MINI1207	Mini Back with Kidabra print inc. Mini Set hardware	31Wx18H cm 12x07"	£602
MINI1210	Mini Back with Kidabra print inc. Mini Set hardware	31Wx26H cm 12x10"	£602
MINI1212	Mini Back with Kidabra print inc. Mini Set hardware	31Wx31H cm 12x12"	£602
MINI1214	Mini Back with Kidabra print inc. Mini Set hardware	31Wx36H cm 12x14"	£602
MINI1307	Mini Back with Kidabra print inc. Mini Set hardware	33Wx18H cm 13x07"	£602
MINI1310	Mini Back with Kidabra print inc. Mini Set hardware	33Wx26H cm 13x10"	£602
MINI1312	Mini Back with Kidabra print inc. Mini Set hardware	33Wx31H cm 13x12"	£602
MINI1314	Mini Back with Kidabra print inc. Mini Set hardware	33Wx36H cm 13x14"	£602
MINI1407	Mini Back with Kidabra print inc. Mini Set hardware	36Wx18H cm 14x07"	£602
MINI1410	Mini Back with Kidabra print inc. Mini Set hardware	36Wx26H cm 14x10"	£602
MINI1412	Mini Back with Kidabra print inc. Mini Set hardware	36Wx31H cm 14x12"	£602
MINI1414	Mini Back with Kidabra print inc. Mini Set hardware	36Wx36H cm 14x14"	£602
<b>Additional options</b>			
	Swing away lateral		Chest harness interface kit
	Mini-Flex support band		
1627466	Swing-away lateral (each)	Hardware only	£173
EPAD-XS	Extra small lateral pad	Hardware not included	£91
1627465	Chest harness interface kit		£64
1631855	Mini-Flex support band	4.5in high	£131
1631856	Mini-Flex support band	6in high	£131

Order No :  
Customer Ref :

## Mini Elan headrest



1603251	Mini Elan headrest (28cm)	Hardware only	£198
1603255	Standard Pad - Small (16Wx9H cm)	Standard cover	£131
1603294	Standard Pad - Small (16Wx9H cm)	Wipedown cover	£131

### Replacement options

1626831	Mini Back cover with Kidabra print	26Wx18H cm	10x07"	£149
1626832	Mini Back cover with Kidabra print	26Wx26H cm	10x10"	£149
1626833	Mini Back cover with Kidabra print	26Wx31H cm	10x12"	£149
1626834	Mini Back cover with Kidabra print	28Wx18H cm	11x07"	£149
1626835	Mini Back cover with Kidabra print	28Wx26H cm	11x10"	£149
1626836	Mini Back cover with Kidabra print	28Wx31H cm	11x12"	£149
1626837	Mini Back cover with Kidabra print	31Wx18H cm	12x07"	£149
1626838	Mini Back cover with Kidabra print	31Wx26H cm	12x10"	£149
1626839	Mini Back cover with Kidabra print	31Wx31H cm	12x12"	£149
1626840	Mini Back cover with Kidabra print	31Wx36H cm	21x14"	£149
1626841	Mini Back cover with Kidabra print	33Wx18H cm	13x07"	£149
1626842	Mini Back cover with Kidabra print	33Wx26H cm	13x10"	£149
1626843	Mini Back cover with Kidabra print	33Wx31H cm	13x12"	£149
1626844	Mini Back cover with Kidabra print	33Wx36H cm	13x14"	£149
1626845	Mini Back cover with Kidabra print	36Wx18H cm	14x07"	£149
1626846	Mini Back cover with Kidabra print	36Wx26H cm	14x10"	£149
1626847	Mini Back cover with Kidabra print	36Wx31H cm	14x12"	£149
1626848	Mini Back cover with Kidabra print	36Wx36H cm	14x14"	£149
1626822	Matrx Mini-Set Hardware			£173

**TOTAL PRICE:**

### Special Instructions - Please supply the following information:



**Name:**

**Email:**

**Phone:**

**Description of special request (please include relevant option code):**

Order No :

Customer Ref :



Yes, you can.<sup>®</sup>

Tel: 01656 776222 Fax: 01656 776220

Email: ordersuk@invacare.com

www.invacare.co.uk

RETAIL PRESCRIPTION FORM

Matrx Elite back

April 2020

<b>Account Name :</b>	<b>Account No :</b>
<b>Address :</b>	<b>Order No :</b>
<b>Tel No:</b>	<b>Order Qty :</b>
<b>Delivery address :</b>	<b>Order Date :</b>

**Matrx Elite back**  
Retail order form  
Maximum User Weight: 136kg

**Standard Features:**  
3" Contour Depth  
40° angle adjustment  
4" depth adjustment  
20° rotation  
136kg (21 stone) user weight  
Hardware not included



Standard Matrx Elite Backrest (No Hardware)											
Chest Width	Backrest Width**	Backrest Height							Fits W/ch Widths	With Extended Mounting Pins EMP*	
		28cm (10")	31cm (12")	36cm (14")	41cm (16")	46cm (18")	51cm (20")	51cm Full (20" Full)			
≤20cm (8")	31cm (12")				PBE1216NH	PBE1218NH			31cm - 33cm (12" - 13")	36cm (14")	
≤23cm (9")	33cm (13")				PBE1316NH	PBE1318NH			33cm - 36cm (13" - 14")	38cm (15")	
≤26cm (10")	36cm (14")	PBE1410NH	PBE1412NH	PBE1414NH	PBE1416NH	PBE1418NH	PBE1420NH		36cm - 38cm (14" - 15")	41cm (16")	
≤28cm (11")	38cm (15")	PBE1510NH	PBE1512NH	PBE1514NH	PBE1516NH	PBE1518NH	PBE1520NH		38cm - 41cm (15" - 16")	43cm (17")	
≤31cm (12")	41cm (16")	PBE1610NH	PBE1612NH	PBE1614NH	PBE1616NH	PBE1618NH	PBE1620NH	PBE1620NH~	41cm - 43cm (16" - 17")	46cm (18")	
≤33cm (13")	43cm (17")	PBE1710NH	PBE1712NH	PBE1714NH	PBE1716NH	PBE1718NH	PBE1720NH	PBE1720NH~	43cm - 46cm (17" - 18")	48cm (19")	
≤36cm (14")	46cm (18")	PBE1810NH	PBE1812NH	PBE1814NH	PBE1816NH	PBE1818NH	PBE1820NH	PBE1820NH~	46cm - 48cm (18" - 19")	51cm (20")	
≤38cm (15")	48cm (19")	PBE1910NH	PBE1912NH		PBE1916NH	PBE1918NH	PBE1920NH	PBE1920NH~	48cm - 51cm (19" - 20")	53cm (21")	
≤41cm (16")	51cm (20")	PBE2010NH	PBE2012NH		PBE2016NH	PBE2018NH	PBE2020NH	PBE2020NH~	51cm - 53cm (20" - 21")	56cm (22")	

\*Not suitable for HD users (max. 136kg/300lb weight capacity)  
\*\*It is recommended that you select a backrest 26mm (1") wider when fitting lateral supports.

Code	X	Description	Fits wheelchair widths:		Price
<b>Matrx Elite back</b>					
PBE1216NH		Matrx Elite back	31cm - 33cm	(12" - 13")	£410
PBE1218NH		Matrx Elite back	31cm - 33cm	(12" - 13")	£410
PBE1316NH		Matrx Elite back	33cm - 36cm	(13" - 14")	£410
PBE1318NH		Matrx Elite back	33cm - 36cm	(13" - 14")	£410
PBE1410NH		Matrx Elite back	36cm - 38cm	(14" - 15")	£410
PBE1412NH		Matrx Elite back	36cm - 38cm	(14" - 15")	£410
PBE1414NH		Matrx Elite back	36cm - 38cm	(14" - 15")	£410
PBE1416NH		Matrx Elite back	36cm - 38cm	(14" - 15")	£410
PBE1418NH		Matrx Elite back	36cm - 38cm	(14" - 15")	£410
PBE1420NH		Matrx Elite back	36cm - 38cm	(14" - 15")	£410
PBE1510NH		Matrx Elite back	38cm - 41cm	(15" - 16")	£410
PBE1512NH		Matrx Elite back	38cm - 41cm	(15" - 16")	£410
PBE1514NH		Matrx Elite back	38cm - 41cm	(15" - 16")	£410
PBE1516NH		Matrx Elite back	38cm - 41cm	(15" - 16")	£410
PBE1518NH		Matrx Elite back	38cm - 41cm	(15" - 16")	£410
PBE1520NH		Matrx Elite back	38cm - 41cm	(15" - 16")	£410
PBE1610NH		Matrx Elite back	41cm - 43cm	(16" - 17")	£410

Order No :  
Customer Ref :

Matrx Elite  
1 of 3

Subject to Invacare's standard Terms and Conditions.  
Invacare reserve the right to alter product specification without prior notice.

PBE1612NH	Matrx Elite back	41cm - 43cm	(16" - 17")	£410
PBE1614NH	Matrx Elite back	41cm - 43cm	(16" - 17")	£410
PBE1616NH	Matrx Elite back	41cm - 43cm	(16" - 17")	£410
PBE1618NH	Matrx Elite back	41cm - 43cm	(16" - 17")	£410
PBE1620NH	Matrx Elite back	41cm - 43cm	(16" - 17")	£410
PBE1710NH	Matrx Elite back	43cm - 46cm	(17" - 18")	£410
PBE1712NH	Matrx Elite back	43cm - 46cm	(17" - 18")	£410
PBE1714NH	Matrx Elite back	43cm - 46cm	(17" - 18")	£410
PBE1716NH	Matrx Elite back	43cm - 46cm	(17" - 18")	£410
PBE1718NH	Matrx Elite back	43cm - 46cm	(17" - 18")	£410
PBE1720NH	Matrx Elite back	43cm - 46cm	(17" - 18")	£410
PBE1810NH	Matrx Elite back	46cm - 48cm	(18" - 19")	£410
PBE1812NH	Matrx Elite back	46cm - 48cm	(18" - 19")	£410
PBE1814NH	Matrx Elite back	46cm - 48cm	(18" - 19")	£410
PBE1816NH	Matrx Elite back	46cm - 48cm	(18" - 19")	£410
PBE1818NH	Matrx Elite back	46cm - 48cm	(18" - 19")	£410
PBE1820NH	Matrx Elite back	46cm - 48cm	(18" - 19")	£410
PBE1910NH	Matrx Elite back	48cm - 51cm	(19" - 20")	£410
PBE1912NH	Matrx Elite back	48cm - 51cm	(19" - 20")	£410
PBE1916NH	Matrx Elite back	48cm - 51cm	(19" - 20")	£410
PBE1918NH	Matrx Elite back	48cm - 51cm	(19" - 20")	£410
PBE1920NH	Matrx Elite back	48cm - 51cm	(19" - 20")	£410
PBE2010NH	Matrx Elite back	51cm - 53cm	(20" - 21")	£410
PBE2012NH	Matrx Elite back	51cm - 53cm	(20" - 21")	£410
PBE2016NH	Matrx Elite back	51cm - 53cm	(20" - 21")	£410
PBE2018NH	Matrx Elite back	51cm - 53cm	(20" - 21")	£410
PBE2020NH	Matrx Elite back	51cm - 53cm	(20" - 21")	£410

#### Hardware

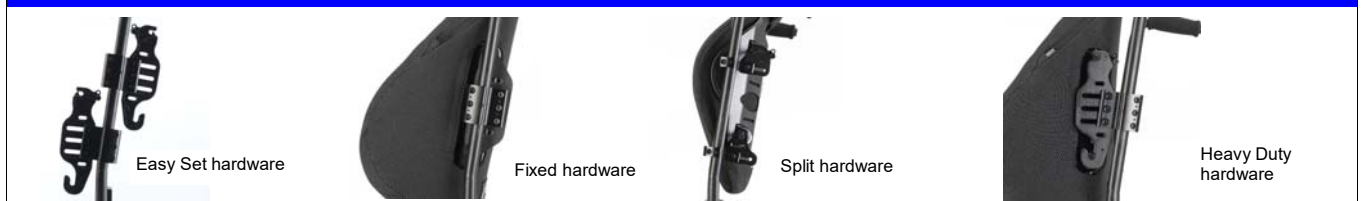

PBMH	Easy Set mounting hardware (pair)	Fits 19mm, 22mm and 25mm back canes	£198
PBMHQ	Easy Set mounting hardware (pair)	Fits 29mm back canes	£198
FSSH	Fixed Space Saver Mounting Hardware		£198
SMH	Split Mounting hardware		£224
HDMH	Heavy Duty Easy Set Mounting Hardware	Fits 19mm, 22mm and 25mm back canes	£306

#### Laterals



#### Fixed laterals

PBLS-L	Standard Left Lateral (191mm long x 127mm high)	£115
PBLS-R	Standard Right Lateral (191mm long x 127mm high)	£115
PBSS-L	Small Left Lateral (140mm long x 76mm high)	£115
PBSS-R	Small Right Lateral (140mm long x 76mm high)	£115
PBOL-L	Offset Left Lateral (For 76mm height adjustment)	£136
PBOL-R	Offset Right Lateral (For 76mm height adjustment)	£136

#### Swing away laterals

SAHEB	Swing Away Hardware for Left or Right Side	Swings completely behind back. Does not interfere with flip-back arms	£125
OSAH-L	Offset Left Swing Away Hardware (Each)	Allows 76mm higher or lower pad position relative to attachment slot	£123
OSAH-R	Offset Right Swing Away Hardware (Each)	Allows 76mm higher or lower pad position relative to attachment slot	£123
EPAD-XS	Extra Small Lateral Pad 82.5mm x 108mm (Each)		£83
EPAD-S	Small Lateral Pad 89mm x 133mm (Each)		£83

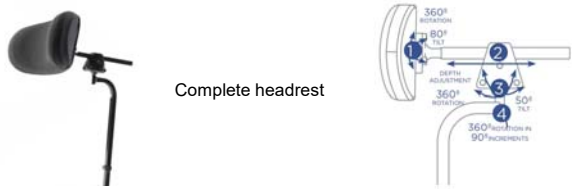

EPAD-M	Medium Lateral Pad 95mm x 146mm (Each)		£83
EPAD-L	Large Lateral Pad 108mm x 165mm (Each)		£83
<b>Harness interface</b>			
CHIEB	Harness Interface to allow attachment of various chest supports without drilling of the back shell		£106
<b>Privacy flap attachment to fit all backs from 30.5cm to 50.5cm wide</b>			
1551799	Extra Small	26cm x 41cm	£53
1551800	Small	33cm x 41cm	£53
1551903	Medium	38cm x 41cm	£53
1551904	Large	43cm x 41cm	£53
<b>Spares</b>			
EMP	Extended Mounting Pins	Allows Matrx backs to be installed on wider wheelchairs	£51
<b>Headrest</b>			
 <p>Complete headrest</p>			
PHRK	250mm soft headrest pad complete with angle and depth adjustable stem		£157
<b>Headrest Receiver to suit backrest width:</b>			
EHRA-S	Small Adapter for backs 12" wide		£24
EHRA-M	Medium Adapter for backs 13-17" wide		£24
EHRA-L	Large Adapter for backs 18-20" wide		£24
			<b>TOTAL PRICE:</b>
<p><b><u>Special Instructions - Please supply the following information:</u></b></p> <p><b><u>Name:</u></b> _____ <b><u>Email:</u></b> _____ <b><u>Phone:</u></b> _____</p> <p><b><u>Description of special request (please include relevant option code):</u></b></p>          			





Tel: 01656 776222 Fax: 01656 776220  
Email: ordersuk@invacare.com  
www.invacare.co.uk

<b>Account Name :</b>	<b>Account No :</b>
<b>Address :</b>	<b>Order No :</b>
<b>Tel No:</b>	<b>Order Qty :</b>
<b>Delivery address :</b>	<b>Order Date :</b>

**Matrx Elite Deep back**  
Retail order form  
Maximum User Weight: 136kg

**Standard Features:**

- 6" Contour Depth
- 40° angle adjustment 4" depth adjustment
- 20° rotation
- 136kg (21 stone) user weight
- Hardware not included



Deep Matrx Elite Backrest (No Hardware)									
Chest Width	Backrest Width	Backrest Height						Fits W/ch Widths	With Extended Mounting Pins EMP*
		28cm (10")	31cm (12")	41cm (16")	46cm (18")	51cm (20")	51cm Full (20" Full)		
≤20cm (8")	31cm (12")	std back only	std back only	std back only				310mm - 330mm (12" - 13")	36cm (14")
≤23cm (9")	33cm (13")	std back only	std back only	std back only				330mm - 360mm (13" - 14")	38cm (15")
≤26cm (10")	36cm (14")	std back only	EDB1412NH	EDB1416NH	EDB1418NH			360mm - 380mm (14" - 15")	41cm (16")
≤28cm (11")	38cm (15")	std back only	EDB1512NH	EDB1516NH	EDB1518NH	EDB1520NH		380mm - 410mm (15" - 16")	43cm (17")
≤31cm (12")	41cm (16")	std back only	EDB1612NH	EDB1616NH	EDB1618NH	EDB1620NH	std back only	410mm - 430mm (16" - 17")	46cm (18")
≤33cm (13")	43cm (17")	std back only	EDB1712NH	EDB1716NH	EDB1718NH	EDB1720NH	std back only	430mm - 460mm (17" - 18")	48cm (19")
≤36cm (14")	46cm (18")	std back only	EDB1812NH	EDB1816NH	EDB1818NH	EDB1820NH	std back only	460mm - 480mm (18" - 19")	51cm (20")
≤38cm (15")	48cm (19")	std back only	EDB1912NH	EDB1916NH	EDB1918NH	EDB1920NH	std back only	480mm - 510mm (19" - 20")	53cm (21")
≤41cm (16")	51cm (20")	std back only	EDB2012NH	EDB2016NH	EDB2018NH	EDB2020NH	std back only	510mm - 530mm (20" - 21")	56cm (22")

\*not suitable for HD users (max. 136kg/300lb weight capacity)

Code	X	Description	Fits wheelchairs		Price
Matrx Elite Deep			Width	Height	
EDB1412NH		Matrx Elite Deep	360mm-380mm	310mm	£518
EDB1416NH		Matrx Elite Deep	360mm-380mm	410mm	£518
EDB1418NH		Matrx Elite Deep	360mm-380mm	460mm	£518
EDB1512NH		Matrx Elite Deep	380mm-410mm	310mm	£518
EDB1516NH		Matrx Elite Deep	380mm-410mm	410mm	£518
EDB1518NH		Matrx Elite Deep	380mm-410mm	460mm	£518
EDB1520NH		Matrx Elite Deep	380mm-410mm	510mm	£518
EDB1612NH		Matrx Elite Deep	410mm-430mm	310mm	£518
EDB1616NH		Matrx Elite Deep	410mm-430mm	410mm	£518
EDB1618NH		Matrx Elite Deep	410mm-430mm	460mm	£518
EDB1620NH		Matrx Elite Deep	410mm-430mm	510mm	£518
EDB1712NH		Matrx Elite Deep	430mm-460mm	310mm	£518
EDB1716NH		Matrx Elite Deep	430mm-460mm	410mm	£518
EDB1718NH		Matrx Elite Deep	430mm-460mm	460mm	£518
EDB1720NH		Matrx Elite Deep	430mm-460mm	510mm	£518
EDB1812NH		Matrx Elite Deep	460mm-480mm	310mm	£518

Order No :  
Customer Ref :

Matrx Elite Deep  
1 of 2

Subject to Invacare's standard Terms and Conditions.  
Invacare reserve the right to alter product specification without prior notice.

EDB1816NH	Matrx Elite Deep	460mm-480mm	410mm	£518
EDB1818NH	Matrx Elite Deep	460mm-480mm	460mm	£518
EDB1820NH	Matrx Elite Deep	460mm-480mm	510mm	£518
EDB1912NH	Matrx Elite Deep	480mm-510mm	310mm	£518
EDB1916NH	Matrx Elite Deep	480mm-510mm	410mm	£518
EDB1918NH	Matrx Elite Deep	480mm-510mm	460mm	£518
EDB1920NH	Matrx Elite Deep	480mm-510mm	510mm	£518
EDB2012NH	Matrx Elite Deep	510mm	310mm	£518
EDB2016NH	Matrx Elite Deep	510mm	410mm	£518
EDB2018NH	Matrx Elite Deep	510mm	460mm	£518
EDB2020NH	Matrx Elite Deep	510mm	510mm	£518

### Hardware



PBMH	Easy Set mounting hardware (pair)	Fits 19mm, 22mm and 25mm back canes	£198
PBMHQ	Easy Set mounting hardware (pair)	Fits 29mm back canes	£198
FSSH	Fixed Space Saver Hardware		£198
SMH	Split Mounting hardware		£224
HDMH	Heavy Duty Mounting Hardware (pair) - metal	Fits 19mm, 22mm and 25mm back canes	£306

### Harness interface

CHIEB	Harness Interface to allow attachment of various chest supports without drilling of the back shell		£106
-------	--	--	------

### Privacy flap attachment to fit all backs from 30.5cm to 50.5cm wide

1551799	Extra Small	26cm x 41cm	£53
1551800	Small	33cm x 41cm	£53
1551903	Medium	38cm x 41cm	£53
1551904	Large	43cm x 41cm	£53

### Spares

EMP	Extended Mounting Pins	Allows Matrx backs to be installed on wider wheelchairs	£51
-----	------------------------	---	-----

### Headrest

PHRK	250mm soft headrest pad complete with angle and depth adjustable stem (All hardware included)		£157
------	---	--	------

### Headrest Receiver to suit backrest width:

EHRA-S	Small Adapter for backs 12" wide		£24
EHRA-M	Medium Adapter for backs 13-17" wide		£24
EHRA-L	Large Adapter for backs 18-20" wide		£24

**TOTAL PRICE:**

**Special Instructions - Please supply the following information:**

**Name:** \_\_\_\_\_ **Email:** \_\_\_\_\_ **Phone:** \_\_\_\_\_

**Description of special request (please include relevant option code):**

\_\_\_\_\_

\_\_\_\_\_

\_\_\_\_\_



Tel: 01656 776222 Fax: 01656 776220  
Email: ordersuk@invacare.com  
www.invacare.co.uk

<b>Account Name :</b>	<b>Account No :</b>
<b>Address :</b>	<b>Order No :</b>
<b>Tel No:</b>	<b>Order Qty :</b>
<b>Delivery address :</b>	<b>Order Date :</b>

**Matrx Elite Full back**  
Retail order form  
Maximum User Weight: 136kg

		<b>WIDTH</b>				
<b>HEIGHT</b>	cm	41	43	46	48	51
	inch	16	17	18	19	20
	51	20				

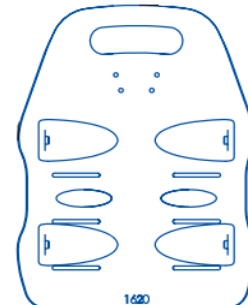

**Standard Features:**  
3" Contour Depth  
40° angle adjustment  
4" depth adjustment  
20° rotation  
136kg (21 stone) user weight  
Hardware not included

Code	X	Description	Fits wheelchairs		Price
Matrx Elite full back			Width	Height	
PBE1620FBNH		Matrx Elite full back	410mm-430mm	510mm	£410
PBE1720FBNH		Matrx Elite full back	430mm-460mm	510mm	£410
PBE1820FBNH		Matrx Elite full back	460mm-480mm	510mm	£410
PBE1920FBNH		Matrx Elite full back	480mm-510mm	510mm	£410
PBE2020FBNH		Matrx Elite full back	510mm	510mm	£410

**Hardware**

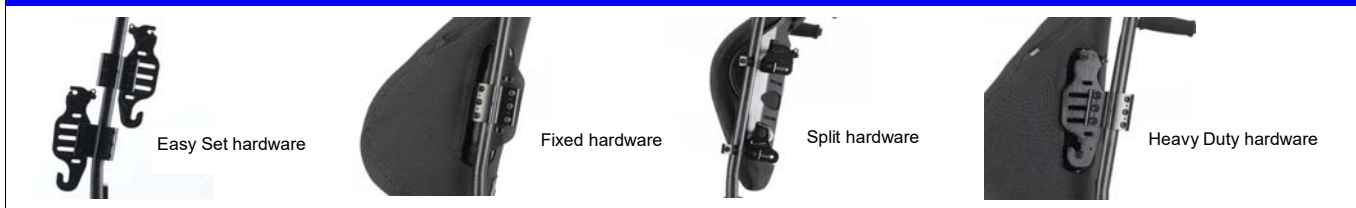

PBMH		Easy Set mounting hardware (pair)	Fits 19mm, 22mm and 25mm back canes	£198
PBMHQ		Easy Set mounting hardware (pair)	Fits 29mm back canes	£198
FSSH		Fixed Space Saver Mounting Hardware		£198
SMH		Split Mounting hardware		£224
HDMH		Heavy Duty Easy Set Mounting Hardware	Fits 19mm, 22mm and 25mm back canes	£306

**Harness interface**

CHIEB		Harness Interface to allow attachment of various chest supports without drilling of the back shell		£106
-------	--	--	--	------

Privacy flap attachment to fit all backs from 30.5cm to 50.5cm wide			
1551799	Extra Small	26cm x 41cm	£53
1551800	Small	33cm x 41cm	£53
1551903	Medium	38cm x 41cm	£53
1551904	Large	43cm x 41cm	£53
Spares			
EMP	Extended Mounting Pins	Allows Matrix backs to be installed on wider wheelchairs	£51
Headrest			
PHRK	250mm soft headrest pad complete with angle and depth adjustable stem (All hardware included)		£157
Headrest Receiver to suit backrest width:			
EHRA-S	Small Adapter for backs 12" wide		£24
EHRA-M	Medium Adapter for backs 13-17" wide		£24
EHRA-L	Large Adapter for backs 18-20" wide		£24
<b>TOTAL PRICE:</b>			

**Special Instructions - Please supply the following information:**



**Name:**

**Email:**

**Phone:**

**Description of special request (please include relevant option code):**



Yes, you can.®

Tel: 01656 776222 Fax: 01656 776220  
 Email: ordersuk@invacare.com  
 Online spares available at www.invacare.co.uk

Matrx Elite TR back  
 April 2020

<b>Account Name :</b>	<b>Account No :</b>
<b>Address :</b>	<b>Order No :</b>
<b>Tel No:</b>	<b>Order Qty :</b>
<b>Delivery address :</b>	<b>Order Date :</b>

**Matrx Elite TR back**  
 Retail order form  
 Specially designed for Tilt and Recline wheelchairs

WIDTH

HEIGHT

cm		41	43	46	48	51
	inch	16	17	18	19	20
41	16					
46	18					
51	20					



**Standard features**  
 Back Shell made without scapular  
 Cutout and includes  
 SuperSoft foam  
 Recommended for Tilt/Recline applications  
 136kg (21 stone) user weight  
 Hardware not included

Code	X	Description	Fits wheelchairs		Price
Matrx Elite			Width	Height	
PBE1616-TR		Matrx Elite TR	410mm-430mm	410mm	£518
PBE1618-TR		Matrx Elite TR	410mm-430mm	460mm	£518
PBE1620-TR		Matrx Elite TR	410mm-430mm	510mm	£518
PBE1716-TR		Matrx Elite TR	430mm-460mm	410mm	£518
PBE1718-TR		Matrx Elite TR	430mm-460mm	460mm	£518
PBE1720-TR		Matrx Elite TR	430mm-460mm	510mm	£518
PBE1816-TR		Matrx Elite TR	460mm-480mm	410mm	£518
PBE1818-TR		Matrx Elite TR	460mm-480mm	460mm	£518
PBE1820-TR		Matrx Elite TR	460mm-480mm	510mm	£518
PBE1916-TR		Matrx Elite TR	480mm-510mm	410mm	£518
PBE1918-TR		Matrx Elite TR	480mm-510mm	460mm	£518
PBE1920-TR		Matrx Elite TR	480mm-510mm	510mm	£518
PBE2016-TR		Matrx Elite TR	510mm	410mm	£518
PBE2018-TR		Matrx Elite TR	510mm	460mm	£518
PBE2020-TR		Matrx Elite TR	510mm	510mm	£518

Order No :  
 Customer Ref :

## Hardware



PBMH	Easy Set mounting hardware (pair)	Fits 19mm, 22mm and 25mm back canes	£198
PBMHQ	Easy Set mounting hardware (pair)	Fits 29mm back canes	£198
FSSH	Fixed Space Saver Hardware		£198
SMH	Split Mounting hardware		£224
HDMH	Heavy Duty Mounting Hardware (pair) - metal	Fits 19mm, 22mm and 25mm back canes	£306

## Harness interface

CHIEB	Harness Interface to allow attachment of various chest supports without drilling of the back shell	Width, angle and height adjustability for precise orientation of shoulder straps	£106
-------	--	--	------

## Privacy flap attachment to fit all backs from 30.5cm to 50.5cm wide

1551799	Privacy Flap - Extra Small	26cm x 41cm	£53
1551800	Privacy Flap - Small	33cm x 41cm	£53
1551903	Privacy Flap - Medium	38cm x 41cm	£53
1551904	Privacy Flap - Large	43cm x 41cm	£53

## Spares

EMP	Extended Mounting Pins	Allows Matrix backs to be installed on wider wheelchairs	£51
-----	------------------------	--	-----

**TOTAL PRICE:**

### Special Instructions - Please supply the following information:



**Name:**

**Email:**

**Phone:**

**Description of special request (please include relevant option code):**



Tel: 01656 776222 Fax: 01656 776220  
Email: ordersuk@invacare.com  
Online spares available at www.invacare.co.uk

<b>Account Name :</b>	<b>Account No :</b>
<b>Address :</b>	<b>Order No :</b>
<b>Tel No:</b>	<b>Order Qty :</b>
<b>Delivery address :</b>	<b>Order Date :</b>

**Matrx Posture Back**  
Retail order form  
Maximum User Weight: 136kg

**Features**  
5" Contour Depth  
40° angle adjustment  
4" depth adjustment  
20° rotation  
136kg (21 stone) user weight  
Hardware not included



Standard MatRX Posture Back Backrest (no hardware)									
Chest Width	Backrest Width	31cm	41cm	51cm	Fits W/ch Widths		With Extended Mounting Pins EMP*		
		(12")	(16")	(20")					
≤26cm (10")	36cm (14")	MPB1412NH	MPB1416NH		33cm - 38cm	(13" - 15")	41cm	(16")	
≤31cm (12")	41cm (16")	MPB1612NH	MPB1616NH	MPB1620NH	38cm - 43cm	(15" - 17")	46cm	(18")	
≤33cm (13")	43cm (17")	MPB1712NH	MPB1716NH	MPB1720NH	41cm - 46cm	(16" - 18")	48cm	(19")	
≤36cm (14")	46cm (18")	MPB1812NH	MPB1816NH	MPB1820NH	43cm - 48cm	(17" - 19")	51cm	(20")	
≤41cm (16")	51cm (20")	MPB2021NH	MPB2016NH	MPB2020NH	48cm - 53cm	(19" - 21")	56cm	(22")	

\*not suitable for HD users (max. 136kg/300lb weight capacity)

Code	X	Description	Fits wheelchairs		Price
			Width	Height	
<b>Matrx PB</b>					
MPB1412NH		Matrx Posture Back	330mm-380mm	310mm	£410
MPB1416NH		Matrx Posture Back	330mm-380mm	410mm	£410
MPB1612NH		Matrx Posture Back	380mm-430mm	310mm	£410
MPB1616NH		Matrx Posture Back	380mm-430mm	410mm	£410
MPB1620NH		Matrx Posture Back	380mm-430mm	510mm	£410
MPB1712NH		Matrx Posture Back	410mm-460mm	310mm	£410
MPB1716NH		Matrx Posture Back	410mm-460mm	410mm	£410
MPB1720NH		Matrx Posture Back	410mm-460mm	510mm	£410
MPB1812NH		Matrx Posture Back	430mm-480mm	310mm	£410
MPB1816NH		Matrx Posture Back	430mm-480mm	410mm	£410
MPB1820NH		Matrx Posture Back	430mm-480mm	510mm	£410
MPB2012NH		Matrx Posture Back	480mm-510mm	310mm	£410
MPB2016NH		Matrx Posture Back	480mm-510mm	410mm	£410
MPB2020NH		Matrx Posture Back	480mm-510mm	510mm	£410

**Hardware**

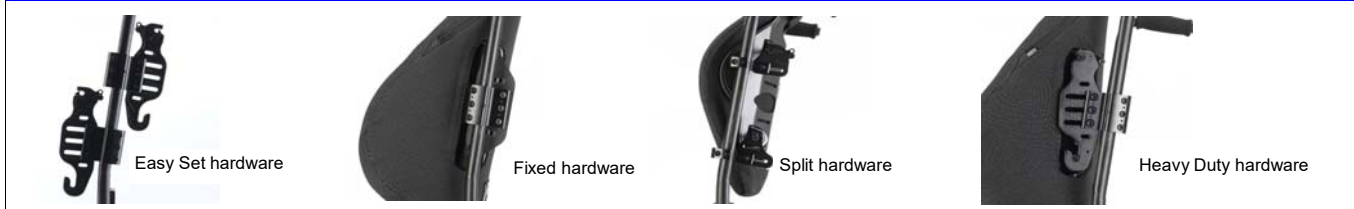

PBMH	Easy Set mounting hardware (pair)	Fits 19mm, 22mm and 25mm back canes	£198
PBMHQ	Easy Set mounting hardware (pair)	Fits 29mm back canes	£198
FSSH	Fixed Space Saver Mounting Hardware		£198
SMH	Split Mounting hardware		£224
HDMH	Heavy Duty Easy Set Mounting Hardware	Fits 19mm, 22mm and 25mm back canes	£306

**Harness interface**

CHIPB	Harness Interface to allow attachment of various chest supports without drilling of the back shell	Width, angle and height adjustability for precise orientation of shoulder straps	£59
-------	--	--	-----

**Privacy flap attachment to fit all backs from 30.5cm to 50.5cm wide**

1551799	Extra Small	26cm x 41cm	£53
1551800	Small	33cm x 41cm	£53
1551903	Medium	38cm x 41cm	£53
1551904	Large	43cm x 41cm	£53

**Spares**

EMP	Extended Mounting Pins	Allows Matrx backs to be installed on wider wheelchairs	£51
-----	------------------------	---	-----

**Headrest**

PHRK	250mm soft headrest pad complete with angle and depth adjustable stem (All hardware included)		£157
------	---	--	------

**Headrest Receiver to suit backrest width:**

EHRA-S	Small Adapter for backs 12" wide	£24
EHRA-M	Medium Adapter for backs 13-17" wide	£24
EHRA-L	Large Adapter for backs 18-20" wide	£24

**TOTAL PRICE:**



**Special Instructions - Please supply the following information:**

**Name:**

**Email:**

**Phone:**

**Description of special request (please include relevant option code):**



Yes, you can.®

Tel: 01656 776222 Fax: 01656 776220  
 Email: ordersuk@invacare.com  
 www.invacare.co.uk

Matrix Posture back Deep  
 April 2020

<b>Account Name :</b>	<b>Account No :</b>
<b>Address :</b>	<b>Order No :</b>
<b>Tel No:</b>	<b>Order Qty :</b>
<b>Delivery address :</b>	<b>Order Date :</b>

**Matrix Posture Back Deep**  
 Retail order form  
 Maximum User Weight: 227 kg

**Features**  
 5" Contour Depth  
 40° angle adjustment  
 4" depth adjustment  
 20° rotation  
 136kg (21 stone) user weight  
 Hardware not included



Deep MatRX Posture Back Backrest									
Chest Width	Backrest Width	31cm	41cm	51cm	Fits Wch Widths		With Extended Mounting Pins EMP*		
		(12")	(16")	(20")					
≤26cm (10")	36cm (14")	PBD1412NH	PBD1416NH		33cm - 38cm	(13" - 15")	41cm	(16")	
≤31cm (12")	41cm (16")	PBD1612NH	PBD1616NH	PBD1620NH	38cm - 43cm	(15" - 17")	46cm	(18")	
≤33cm (13")	43cm (17")	PBD1712NH	PBD1716NH	PBD1720NH	41cm - 46cm	(16" - 18")	48cm	(19")	
≤36cm (14")	46cm (18")	PBD1812NH	PBD1816NH	PBD1820NH	43cm - 48cm	(17" - 19")	51cm	(20")	
≤41cm (16")	51cm (20")	PBD2012NH	PBD2016NH	PBD2020NH	48cm - 53cm	(19" - 21")	56cm	(22")	

\*Not suitable for HD users (max. 136kg/300lb weight capacity)

Code	X	Description	Fits wheelchairs		Price
PB Deep					
			Width	Height	
PBD1412NH		Posture Back Deep	330mm-380mm	310mm	£518
PBD1416NH		Posture Back Deep	330mm-380mm	410mm	£518
PBD1612NH		Posture Back Deep	380mm-430mm	310mm	£518
PBD1616NH		Posture Back Deep	380mm-430mm	410mm	£518
PBD1620NH		Posture Back Deep	380mm-430mm	510mm	£518
PBD1712NH		Posture Back Deep	410mm-460mm	310mm	£518
PBD1716NH		Posture Back Deep	410mm-460mm	410mm	£518
PBD1720NH		Posture Back Deep	410mm-460mm	510mm	£518
PBD1812NH		Posture Back Deep	430mm-480mm	310mm	£518
PBD1816NH		Posture Back Deep	430mm-480mm	410mm	£518
PBD1820NH		Posture Back Deep	430mm-480mm	510mm	£518
PBD2012NH		Posture Back Deep	480mm-530mm	310mm	£518
PBD2016NH		Posture Back Deep	480mm-530mm	410mm	£518
PBD2020NH		Posture Back Deep	480mm-530mm	510mm	£518
Hardware					
PBMH		Easy Set mounting hardware (pair)	Fits 19mm, 22mm and 25mm back canes		£198
PBMHQ		Easy Set mounting hardware (pair)	Fits 29mm back canes		£198
FSSH		Fixed Space Saver Hardware			£198
SMH		Split Mounting hardware			£224
HDMH		Heavy Duty Mounting Hardware (pair) - metal	Fits 19mm, 22mm and 25mm back canes		£306

Order No :

Customer Ref :

Harness interface			
CHIPB	Harness Interface to allow attachment of various chest supports without drilling of the back shell	Width, angle and height adjustability for precise orientation of shoulder straps	£59
Privacy flap attachment to fit all backs from 30.5cm to 50.5cm wide			
1551799	Extra Small	26cm x 41cm	£53
1551800	Small	33cm x 41cm	£53
1551903	Medium	38cm x 41cm	£53
1551904	Large	43cm x 41cm	£53
Spares			
EMP	Extended Mounting Pins	Allows Matrix backs to be installed on wider wheelchairs	£51
Headrest			
PHRK	250mm soft headrest pad complete with angle and depth adjustable stem		£157
<b>TOTAL PRICE:</b>			

**Special Instructions - Please supply the following information:**



**Name:**

**Email:**

**Phone:**

**Description of special request (please include relevant option code):**

Order No :

Customer Ref :



Yes, you can.®

Tel: 01656 776222 Fax: 01656 776220  
 Email: ordersuk@invacare.com  
 www.invacare.co.uk

Matrx HD PB back  
 April 2020

<b>Account Name :</b>	<b>Account No :</b>
<b>Address :</b>	<b>Order No :</b>
<b>Tel No:</b>	<b>Order Qty :</b>
<b>Delivery address :</b>	<b>Order Date :</b>

**Matrx Heavy Duty Posture Back**  
 Retail order form  
 Maximum User Weight: 227 kg

		<b>WIDTH</b>			
<b>HEIGHT</b>	<b>cm</b>	51	56	61	76
	<b>inch</b>	20	22	24	30
	41	16			
	51	20			

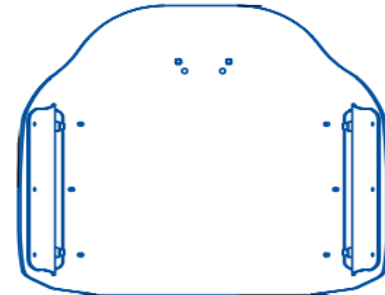

**Features**  
 Heavy-duty hardware included  
 5" Contour Depth  
 40° angle adjustment  
 4" depth adjustment  
 20° rotation  
 227kg (36 stone) user weight

Code	X	Description	Fits wheelchairs		Price
<b>Matrx PB HD</b>			<b>Width</b>	<b>Height</b>	
HDB2016		Heavy Duty Posture Back	510mm-530mm	410mm	£938
HDB2020		Heavy Duty Posture Back	510mm-530mm	510mm	£938
HDB2216		Heavy Duty Posture Back	560mm-590mm	410mm	£938
HDB2220		Heavy Duty Posture Back	560mm-590mm	510mm	£938
HDB2416		Heavy Duty Posture Back	610mm-640mm	410mm	£938
HDB2420		Heavy Duty Posture Back	610mm-640mm	510mm	£938
HDBww16		30" wide Heavy Duty Posture Back	760mm	410mm	£1,515
HDBww20		30" wide Heavy Duty Posture Back	760mm	510mm	£1,515
<b>Harness interface</b>					
CHIPB		Harness Interface to allow attachment of various chest supports without drilling of the back shell	Width, angle and height adjustability for precise orientation of shoulder straps		£59
<b>Privacy flap attachment to fit all backs from 30.5cm to 50.5cm wide</b>					
1551799		Extra Small	26cm x 41cm		£53
1551800		Small	33cm x 41cm		£53
1551903		Medium	38cm x 41cm		£53
1551904		Large	43cm x 41cm		£53
<b>Spares</b>					
EMP		Extended Mounting Pins	Allows Matrx backs to be installed on wider wheelchairs		£51

Order No :  
 Customer Ref :

Headrest		
PHRK	250mm soft headrest pad complete with angle and depth adjustable stem	£157
<b>Headrest Receiver to suit backrest width:</b>		
EHRA-S	Small Adapter for backs 12" wide	£24
EHRA-M	Medium Adapter for backs 13-17" wide	£24
EHRA-L	Large Adapter for backs 18-20" wide	£24
<b>TOTAL PRICE:</b>		

**Special Instructions - Please supply the following information:**



**Name:**

**Email:**

**Phone:**

**Description of special request (please include relevant option code):**

Tel: 01656 776222 Fax: 01656 776220  
Email: ordersuk@invacare.com  
www.invacare.co.uk

<b>Account Name :</b>	<b>Account No :</b>
<b>Address :</b>	<b>Order No :</b>
<b>Tel No:</b>	<b>Order Qty :</b>
<b>Delivery address :</b>	<b>Order Date :</b>

**Matrx Heavy Duty Posture Back Deep**  
Retail order form  
Maximum User Weight: 227 kg

**Features:**  
Heavy-duty hardware included  
7" Contour Depth  
40° angle adjustment  
4" depth adjustment  
20° rotation  
227kg (36 stone) user weight

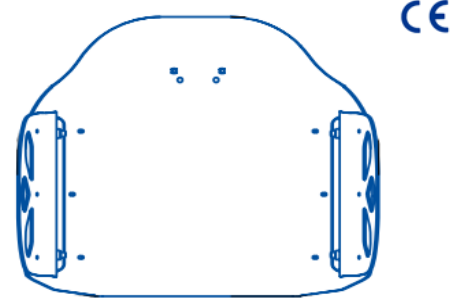

Heavy Duty Deep MatRX Posture Back Backrest (includes heavy duty hardware)									
Chest Width		Backrest Width		31cm (12")	41cm (16")	51cm (20")	Fits W/ch Widths		With Extended Mounting Pins EMP*
<b>41cm</b>	<b>(16")</b>	51cm	(20")	DHD2012	DHD2016	DHD2020	48cm - 53cm	(19" - 21")	
<b>46cm</b>	<b>(18")</b>	56cm	(22")	DHD2212	DHD2216	DHD2220	53cm - 58cm	(21" - 23")	
<b>51cm</b>	<b>(20")</b>	61cm	(24")	DHD2412	DHD2416	DHD2420	58cm - 64cm	(23" - 25")	

Code	X	Description	Fits wheelchairs		Price
Matrx PB HD			Width	Height	
DHD2016		Heavy Duty PB Deep	510mm-530mm	410mm	£1,099
DHD2020		Heavy Duty PB Deep	510mm-530mm	510mm	£1,099
DHD2216		Heavy Duty PB Deep	560mm-590mm	410mm	£1,099
DHD2220		Heavy Duty PB Deep	560mm-590mm	510mm	£1,099
DHD2416		Heavy Duty PB Deep	610mm-640mm	410mm	£1,099
DHD2420		Heavy Duty PB Deep	610mm-640mm	510mm	£1,099
DHDww16		30" wide HD Posture Back Deep	760mm	410mm	£1,648
DHDww20		30" wide HD Posture Back Deep	760mm	510mm	£1,648
Harness interface					
CHIPB		Harness Interface to allow attachment of various chest supports without drilling of the back shell	Width, angle and height adjustability for precise orientation of shoulder straps		£59
Privacy flap attachment to fit all backs from 30.5cm to 50.5cm wide					
1551799		Extra Small	26cm x 41cm		£53
1551800		Small	33cm x 41cm		£53
1551903		Medium	38cm x 41cm		£53
1551904		Large	43cm x 41cm		£53
Spares					
EMP		Extended Mounting Pins	Allows Matrx backs to be installed on wider wheelchairs		£51

Headrest		
PHRK	250mm soft headrest pad complete with angle and depth adjustable stem	£157
<b>Headrest Receiver to suit backrest width:</b>		
EHRA-S	Small Adapter for backs 12" wide	£24
EHRA-M	Medium Adapter for backs 13-17" wide	£24
EHRA-L	Large Adapter for backs 18-20" wide	£24
		<b>TOTAL PRICE:</b>

**Special Instructions - Please supply the following information:**



**Name:**

**Email:**

**Phone:**

**Description of special request (please include relevant option code):**





Tel: 01656 776222 Fax: 01656 776220  
 Email: ordersuk@invacare.com  
 www.invacare.co.uk

Matrx spares  
 April 2020

**Matrx MX2 spares  
 Retail pricelist**

Code	Description	Price	
<b>Matrx MX2 spares</b>			
1629022	Spare cover and foam for MX2 14x7"	£157	
1545317	Spare cover and foam for MX2 14x10"	£157	
1545318	Spare cover and foam for MX2 14x13"	£157	
1545319	Spare cover and foam for MX2 14x17"	£157	
1629023	Spare cover and foam for MX2 15x7"	£157	
1545320	Spare cover and foam for MX2 15x10"	£157	
1545321	Spare cover and foam for MX2 15x13"	£157	
1545322	Spare cover and foam for MX2 15x17"	£157	
1629024	Spare cover and foam for MX2 16x7"	£157	
1545323	Spare cover and foam for MX2 16x10"	£157	
1545324	Spare cover and foam for MX2 16x13"	£157	
1545325	Spare cover and foam for MX2 16x17"	£157	
1629025	Spare cover and foam for MX2 17x7"	£157	
1545326	Spare cover and foam for MX2 17x10"	£157	
1545515	Spare cover and foam for MX2 17x13"	£157	
1545524	Spare cover and foam for MX2 17x17"	£157	
1629026	Spare cover and foam for MX2 18x7"	£157	
1545525	Spare cover and foam for MX2 18x10"	£157	
1545526	Spare cover and foam for MX2 18x13"	£157	
1545683	Spare cover and foam for MX2 18x17"	£157	
<b>Hardware</b>			
1629027	Fixed hardware for MX2	Fixed carbon fibre hardware	£189
1629028	Mini Set hardware MX2	Mini set quick release hardware	£256

**Matrx Elite range spares  
 Retail pricelist**

Code	Description	Price
<b>Matrx Elite spares</b>		
PBEC1210	Spare cover and foam for Elite 12x10"	£149
PBEC1212	Spare cover and foam for Elite 12x12"	£149
PBEC1214	Spare cover and foam for Elite 12x14"	£149
PBEC1216	Spare cover and foam for Elite 12x16"	£149
PBEC1310	Spare cover and foam for Elite 13x10"	£149
PBEC1312	Spare cover and foam for Elite 13x12"	£149
PBEC1314	Spare cover and foam for Elite 13x14"	£149
PBEC1316	Spare cover and foam for Elite 13x16"	£149
PBEC1410	Spare cover and foam for Elite 14x10"	£149
PBEC1412	Spare cover and foam for Elite 12x19"	£149
PBEC1414	Spare cover and foam for Elite 14x14"	£149
PBEC1416	Spare cover and foam for Elite 14x16"	£149
PBEC1418	Spare cover and foam for Elite 14x18"	£149
PBEC1510	Spare cover and foam for Elite 15x10"	£149
PBEC1512	Spare cover and foam for Elite 15x12"	£149
PBEC1516	Spare cover and foam for Elite 15x16"	£149
PBEC1518	Spare cover and foam for Elite 15x18"	£149
PBEC1520	Spare cover and foam for Elite 15x20"	£149
PBEC1610	Spare cover and foam for Elite 16x10"	£149
PBEC1612	Spare cover and foam for Elite 16x12"	£149

PBEC1616	Spare cover and foam for Elite 16x16"	£149
PBEC1618	Spare cover and foam for Elite 16x18"	£149
PBEC1620	Spare cover and foam for Elite 16x20"	£149
PBEC1710	Spare cover and foam for Elite 17x10"	£149
PBEC1712	Spare cover and foam for Elite 17x12"	£149
PBEC1716	Spare cover and foam for Elite 17x16"	£149
PBEC1718	Spare cover and foam for Elite 17x18"	£149
PBEC1720	Spare cover and foam for Elite 17x20"	£149
PBEC1810	Spare cover and foam for Elite 18x10"	£149
PBEC1812	Spare cover and foam for Elite 18x12"	£149
PBEC1816	Spare cover and foam for Elite 18x16"	£149
PBEC1818	Spare cover and foam for Elite 18x18"	£149
PBEC1820	Spare cover and foam for Elite 18x20"	£149
PBEC1910	Spare cover and foam for Elite 19x10"	£149
PBEC1912	Spare cover and foam for Elite 19x12"	£149
PBEC1916	Spare cover and foam for Elite 19x16"	£149
PBEC1918	Spare cover and foam for Elite 19x18"	£149
PBEC1920	Spare cover and foam for Elite 19x20"	£149
PBEC2010	Spare cover and foam for Elite 20x10"	£149
PBEC2012	Spare cover and foam for Elite 20x12"	£149
PBEC2016	Spare cover and foam for Elite 20x16"	£149
PBEC2018	Spare cover and foam for Elite 20x18"	£149
PBEC2020	Spare cover and foam for Elite 20x20"	£149

#### Matrx Elite Full back spares

PBEC1620FB	Spare cover and foam for Elite full back 16x20"	£149
PBEC1720FB	Spare cover and foam for Elite full back 17x20"	£149
PBEC1820FB	Spare cover and foam for Elite full back 18x20"	£149
PBEC1920FB	Spare cover and foam for Elite full back 19x20"	£149
PBEC2020FB	Spare cover and foam for Elite full back 20x20"	£149

#### Matrx Elite Deep spares

EDBC1412	Spare cover and foam for Elite Deep 14x12"	£149
EDBC1416	Spare cover and foam for Elite Deep 14x16"	£149
EDBC1418	Spare cover and foam for Elite Deep 14x18"	£149
EDBC1512	Spare cover and foam for Elite Deep 15x12"	£149
EDBC1516	Spare cover and foam for Elite Deep 15x16"	£149
EDBC1518	Spare cover and foam for Elite Deep 15x18"	£149
EDBC1520	Spare cover and foam for Elite Deep 15x20"	£149
EDBC1612	Spare cover and foam for Elite Deep 16x12"	£149
EDBC1616	Spare cover and foam for Elite Deep 16x16"	£149
EDBC1618	Spare cover and foam for Elite Deep 16x18"	£149
EDBC1620	Spare cover and foam for Elite Deep 16x20"	£149
EDBC1712	Spare cover and foam for Elite Deep 17x12"	£149
EDBC1716	Spare cover and foam for Elite Deep 17x16"	£149
EDBC1718	Spare cover and foam for Elite Deep 17x18"	£149
EDBC1720	Spare cover and foam for Elite Deep 17x20"	£149
EDBC1812	Spare cover and foam for Elite Deep 18x12"	£149
EDBC1816	Spare cover and foam for Elite Deep 18x16"	£149
EDBC1818	Spare cover and foam for Elite Deep 18x18"	£149
EDBC1820	Spare cover and foam for Elite Deep 18x20"	£149
EDBC1912	Spare cover and foam for Elite Deep 19x20"	£149
EDBC1916	Spare cover and foam for Elite Deep 19x16"	£149
EDBC1918	Spare cover and foam for Elite Deep 19x18"	£149
EDBC1920	Spare cover and foam for Elite Deep 19x20"	£149
EDBC2012	Spare cover and foam for Elite Deep 20x12"	£149
EDBC2016	Spare cover and foam for Elite Deep 20x16"	£149
EDBC2018	Spare cover and foam for Elite Deep 20x18"	£149
EDBC2020	Spare cover and foam for Elite Deep 20x20"	£149

<b>Matrx Elite TR spares</b>		
PBEC1616-TR	Spare cover and foam for Elite Tilt & Recline 16x16"	£149
PBEC1618-TR	Spare cover and foam for Elite Tilt & Recline 16x18"	£149
PBEC1620-TR	Spare cover and foam for Elite Tilt & Recline 16x20"	£149
PBEC1716-TR	Spare cover and foam for Elite Tilt & Recline 17x16"	£149
PBEC1718-TR	Spare cover and foam for Elite Tilt & Recline 17x18"	£149
PBEC1720-TR	Spare cover and foam for Elite Tilt & Recline 17x20"	£149
PBEC1816-TR	Spare cover and foam for Elite Tilt & Recline 18x16"	£149
PBEC1818-TR	Spare cover and foam for Elite Tilt & Recline 18x18"	£149
PBEC1820-TR	Spare cover and foam for Elite Tilt & Recline 18x20"	£149
PBEC1916-TR	Spare cover and foam for Elite Tilt & Recline 19x16"	£149
PBEC1918-TR	Spare cover and foam for Elite Tilt & Recline 19x18"	£149
PBEC1920-TR	Spare cover and foam for Elite Tilt & Recline 19x20"	£149
PBEC2016-TR	Spare cover and foam for Elite Tilt & Recline 20x16"	£149
PBEC2018-TR	Spare cover and foam for Elite Tilt & Recline 20x18"	£149
PBEC2020-TR	Spare cover and foam for Elite Tilt & Recline 20x20"	£149

## Matrx Posture Back range spares

### Retail pricelist

<b>Code</b>	<b>Description</b>	<b>Price</b>
<b>Matrx PB spares</b>		
PBC1412	Spare cover only for Posture Back 14x12"	£119
PBC1416	Spare cover only for Posture Back 14x16"	£119
PBC1612	Spare cover only for Posture Back 16x12"	£119
PBC1616	Spare cover only for Posture Back 16x16"	£119
PBC1620	Spare cover only for Posture Back 16x20"	£119
PBC1712	Spare cover only for Posture Back 17x12"	£119
PBC1716	Spare cover only for Posture Back 17x16"	£119
PBC1720	Spare cover only for Posture Back 17x20"	£119
PBC1812	Spare cover only for Posture Back 18x12"	£119
PBC1816	Spare cover only for Posture Back 18x16"	£119
PBC1820	Spare cover only for Posture Back 18x20"	£119
PBC2012	Spare cover only for Posture Back 20x12"	£119
PBC2016	Spare cover only for Posture Back 20x16"	£119
PBC2020	Spare cover only for Posture Back 20x20"	£119
1630952	Spare moulded foam for Posture back 14x12"	£170
1630953	Spare moulded foam for Posture back 14x16"	£170
1630954	Spare moulded foam for Posture back 16x12"	£170
1630955	Spare moulded foam for Posture back 16x16"	£170
1630956	Spare moulded foam for Posture back 16x20"	£170
1630957	Spare moulded foam for Posture back 17x12"	£170
1630958	Spare moulded foam for Posture back 17x16"	£170
1630959	Spare moulded foam for Posture back 17x20"	£170
1630960	Spare moulded foam for Posture back 18x12"	£170
1630961	Spare moulded foam for Posture back 18x16"	£170
1630962	Spare moulded foam for Posture back 18x20"	£170
1630963	Spare moulded foam for Posture back 20x12"	£170
1630964	Spare moulded foam for Posture back 20x16"	£170
1630965	Spare moulded foam for Posture back 20x20"	£170
<b>Matrx PB Deep spares</b>		
DMC1412	Spare cover only for Posture Back Deep 14x12"	£118
DMC1416	Spare cover only for Posture Back Deep 14x16"	£118
DMC1612	Spare cover only for Posture Back Deep 16x12"	£118
DMC1616	Spare cover only for Posture Back Deep 16x16"	£118
DMC1620	Spare cover only for Posture Back Deep 16x20"	£118
DMC1712	Spare cover only for Posture Back Deep 17x12"	£118
DMC1716	Spare cover only for Posture Back Deep 17x16"	£118
DMC1720	Spare cover only for Posture Back Deep 17x20"	£118
DMC1812	Spare cover only for Posture Back Deep 18x12"	£118
DMC1816	Spare cover only for Posture Back Deep 18x16"	£118
DMC1820	Spare cover only for Posture Back Deep 18x20"	£118

DMC2012	Spare cover only for Posture Back Deep 20x12"		£118
DMC2016	Spare cover only for Posture Back Deep 20x16"		£118
DMC2020	Spare cover only for Posture Back Deep 20x20"		£118
1630966	Spare moulded foam for Posture Back Deep 16x16"		£181
1630967	Spare moulded foam for Posture Back Deep 16x20"		£181
1630968	Spare moulded foam for Posture Back Deep 17x16"		£181
1630969	Spare moulded foam for Posture Back Deep 17x20"		£181
1630970	Spare moulded foam for Posture Back Deep 18x16"		£181
1630971	Spare moulded foam for Posture Back Deep 18x20"		£181
1630972	Spare moulded foam for Posture Back Deep 20x16"		£181
1630973	Spare moulded foam for Posture Back Deep 20x20"		£181
<b>Matrx Posture Back HD spares</b>			
HDC2016	Spare cover only for HD Posture Back 20x16"		£118
HDC2020	Spare cover only for HD Posture Back 20x20"		£118
HDC2216	Spare cover only for HD Posture Back 22x18"		£118
HDC2220	Spare cover only for HD Posture Back 22x20"		£118
HDC2416	Spare cover only for HD Posture Back 24x16"		£118
HDC2420	Spare cover only for HD Posture Back 24x20"		£118
<b>Matrx PB Deep HD spares</b>			
DDC2016	Spare cover for HD Deep Posture Back 20x16"		£118
DDC2020	Spare cover for HD Deep Posture Back 20x20"		£118
DDC2216	Spare cover for HD Deep Posture Back 22x16"		£118
DDC2220	Spare cover for HD Deep Posture Back 22x20"		£118
DDC2416	Spare cover for HD Deep Posture Back 24x16"		£118
DDC2420	Spare cover for HD Deep Posture Back 24x20"		£118
<b>Matrx Elite &amp; PB spares</b>			
1630974	Lumbar wedge foam	For 12 and 13" width backs	£11
1630975	Lumbar wedge foam	For 14 and 15" width backs	£11
1630976	Lumbar wedge foam	For 16 and 17" width backs	£11
1630977	Lumbar wedge foam	For 18, 19 and 20" width backs	£11
1630979	4 short mounting pins	Allows the backrest to fit chair 2.5cm narrower or the same size	£51
1630978	4 longer mounting pins	Allows the backrest to fit chair 2.5cm wider	£51
EMP	4 extended mounting pins	Allows Matrx Elite back or Posture Back to be installed on wider wheelchairs	£51
PBMH	Easy Set mounting hardware pair (quick release)		£198
PBMHQ	Easy Set mounting hardware pair for 29mm canes (quick release)		£198
FSSH	Fixed Space Saver Hardware		£198
SMH	Split Mounting Hardware pair (quick release)		£224
HDMH	Heavy Duty mounting hardware (quick release)		£306



Yes, you can.®

Tel: 01656 776222 Fax: 01656 776220  
 Email: ordersuk@invacare.com  
 www.invacare.co.uk

Matrx Elan headrest  
 April 2020

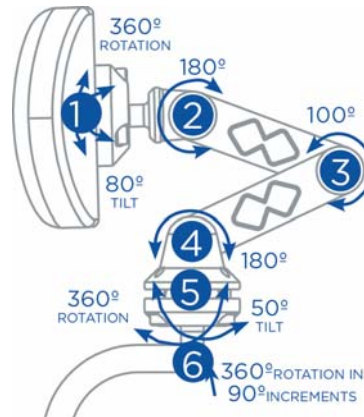

<b>Account Name :</b>	<b>Account No :</b>
<b>Address :</b>	<b>Order No :</b>
<b>Tel No:</b>	<b>Order Qty :</b>
<b>Delivery address :</b>	<b>Order Date :</b>

**Matrx Elan headrest**  
 Retail order form  
 Paediatric - Adult applications

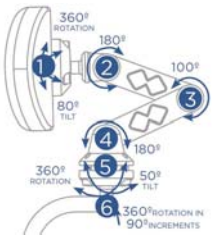

**Standard Features:**

- Award winning design
- 6 point axis with adjustment levers for tool-less re-adjustments
- Multi-disk locking plates with superior holding strength
- Swing away function for easy transfers
- Highly supportive headrest with mouldable plate
- Soft foam co-moulded onto firm foam
- Choice of 3 headrest pads: Standard, occipital or 4 point positioning
- Choice of 3 standard pad sizes: small, medium or large
- Choice of 2 occipital pad sizes: small or large
- Foam surrounds edges of plate
- Ultra-Fresh additive for antimicrobial and odour protection
- Standard or infection control cover with dual zippers

Code	X	Description	Price
		 Matrx Elan headrest	
		 Matrx Elan extended hardware	
		 Standard Matrx headrest	
<b>Hardware</b>			
1603250		Matrx Elan 6-point hardware	38cm vertical post, multi-adjustable £198
1603251		Matrx Elan 6-point mini hardware	28cm vertical post, multi-adjustable £198
1631849		Matrx Elan 6-point extended hardware	38cm vertical post, extra link for severe kyphosis £240
1603249		Matrx standard axis hardware	Height and depth adjustable £165

Order No :

Customer Ref :

## Headpad options



Standard oval pads  
- 3 sizes



Occipital pads  
- 2 sizes



4 point  
- 2 sizes



Headband

1603253	Standard Pad - Large (36Wx13H cm)	Standard cover	£131
1603292	Standard Pad - Large (36Wx13H cm)	Wipedown cover	£131
1603254	Standard Pad - Medium (26Wx13H cm)	Standard cover	£131
1603293	Standard Pad - Medium (26Wx13H cm)	Wipedown cover	£131
1603255	Standard Pad - Small (16Wx9H cm)	Standard cover	£131
1603294	Standard Pad - Small (16Wx9H cm)	Wipedown cover	£131
1603291	Elan Occipital Pad (23Wx18H cm)	Standard cover	£131
1603296	Elan Occipital Pad (23Wx18H cm)	Wipedown cover	£131
1603290	Elan Occipital Pad (31Wx20H cm)	Standard cover	£131
1603295	Elan Occipital Pad (31Wx20H cm)	Wipedown cover	£131
1629822	Small Elan 4-point positioning (23Wx18H cm)	Standard cover	£248
1629823	Small Elan 4-point positioning (23Wx18H cm)	Wipedown cover	£248
1626823	Large Elan 4-Point Positioning (28Wx26H cm)	Standard cover	£248
1626824	Large Elan 4-Point Positioning (28Wx26H cm)	Wipedown cover	£248
1631863	Small Elan 4-Point Positioning pad with head band <b>New</b>	Standard cover	£312
1631864	Small Elan 4-Point Positioning pad with head band <b>New</b>	Wipedown cover	£312
1631865	Large Elan 4-Point Positioning pad with head band <b>New</b>	Standard cover	£312
1631866	Large Elan 4-Point Positioning pad with head band <b>New</b>	Wipedown cover	£312
1631850	Headband only for 4-point headpad <b>New</b>	(requires 2 way zip cover if retro fitting)	£80

## Adapters



Elan adapter for Azalea solid back



Elan adapter for Azalea tension adjustable back

1603252	Elan adapter for Flex 3 solid back	£16
1629412	Elan adapter for Flex 3 tension adjustable back	£21

## Replacement cover options

1603299	Small standard pad cover (16Wx9H cm / 6")	Standard cover	£42
1603311	Small standard pad cover (16Wx9H cm / 6")	Wipedown cover	£42
1603298	Medium standard pad cover (26Wx13H cm / 10")	Standard cover	£42
1603303	Medium standard pad cover (26Wx13H cm / 10")	Wipedown cover	£42
1603297	Large standard pad cover (36Wx13H cm / 14")	Standard cover	£42
1603302	Large standard pad cover (36Wx13H cm / 14")	Wipedown cover	£42
1603301	Small occipital pad cover (23Wx18H cm / 9")	Standard cover	£42
1603313	Small occipital pad cover (23Wx18H cm / 9")	Wipedown cover	£42
1603300	Large occipital pad cover - (31Wx20H cm / 12")	Standard cover	£42
1603312	Large occipital pad cover - (31Wx20H cm / 12")	Wipedown cover	£42
1629824	Small 4 point pad cover - (23Wx18H cm)	Standard cover	£66
1629825	Small 4 point pad cover - (23Wx18H cm)	Wipedown cover	£66
1626849	Large 4 point pad cover - (28Wx26H cm)	Standard cover	£66
1626850	Large 4 point pad cover - (28Wx26H cm)	Wipedown cover	£66
1631851	Small 4 point pad cover with 2 way zip for headband <b>New</b>	Standard cover	£67
1631852	Small 4 point pad cover with 2 way zip for headband <b>New</b>	Wipedown cover	£67
1631853	Large 4 point pad cover with 2 way zip for headband <b>New</b>	Standard cover	£67
1631854	Large 4 point pad cover with 2 way zip for headband <b>New</b>	Wipedown cover	£67

## Spare parts

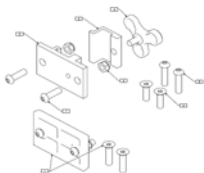

□ Spare clamp kit  
**1629821**  
£72



□ Spare knob kit  
**1629819**  
£27



□ Spare screw kit  
**1629820**  
£3

**TOTAL PRICE:**

Order No :

Customer Ref :



**Special Instructions - Please supply the following information:**

**Name:**

**Email:**

**Phone:**

**Description of special request (please include relevant option code):**

**Order No :**

**Customer Ref :**

Matrix Elan  
Page 3 of 3

Subject to Invacare's standard Terms and Conditions.  
Invacare reserve the right to alter product specification without prior notice.





<b>Bodypoint Pricelist</b> Retail order form		
		
		
Code	Description	Price
<b>HB205 2-point belt</b>		
 <span style="float: right;">HB205</span>		
HB205-M46-B1	Medium x 46cm Pads, flat mount	£72
HB205-M46-B2	Medium x 46cm Pads, cinch mount	£72
HB205-L62-B1	Large x 62cm Pads, flat mount	£72
HB205-L62-B2	Large x 62cm Pads, cinch mount	£72
<b>HB216 2-point belt</b>		
 <span style="float: right;">HB216</span>		
HB216-S38-B2	Small x 38cm Pads, cinch mount	£55
HB216-M46-B2	Medium x 46cm Pads, cinch mount	£55
HB216-L62-B2	Large x 62cm Pads, cinch mount	£55
<b>HB219 2-point belt</b>		
 <span style="float: right;">HB219</span>		
HB219-S38-B2	Small x 38cm Pads, cinch mount	£65
HB219-M46-B2	Medium x 46cm Pads, cinch mount	£65
<b>HB235 2-point belt</b>		
HB235-S32-B1	Extra small x, 32cm Pads, flat mount	£65
HB235-S32-B2	Extra small x, 32cm Pads, cinch mount	£65
HB235-S38-B2	Small x 38cm Pads, cinch mount	£65
<b>Evoflex</b>		
  		
<p>The unique, stiffened straps on pivots keep from the belt from twisting or falling into the wheels as well as staying in right placement angle to ensure they don't get in the way during transfers.</p>		
EB235S	Small pelvic stabilizer, push button	£70
EB225M	Medium pelvic stabilizer, Latch	£70
EB225L	Large pelvic stabilizer, Latch	£70
<b>HB405 4-point belt</b>		
		
HB405-M46-B1	Medium x 46cm Pads, centre pull, push button, flat mount	£85
HB405-L62-B1	Large x 62cm Pads, centre pull, push button, flat mount	£85
HB405-M46-B2	Medium x 46cm Pads, centre pull, push button, cinch mount	£85
HB405-L62-B2	Large x 62cm Pads, centre pull, push button, cinch mount	£85

### HB435 4-point belt



HB435-S38-B2	S x 38cm Pads, centre pull, small push button, cinch mount	£85
--------------	--	-----

### Sub-ASIS pads



PD401-2	Sub-ASIS pads (pair) 120mm	<b>New</b>	£53
PD402-2	Sub-ASIS pads (pair) 100mm	<b>New</b>	£53

### Leg Harness



LH600S-B1	Small Leg Harness with flat mount	£79
LH600M-B1	Medium Leg Harness with flat mount	£79
LH600L-B1	Large Leg Harness with flat mount	£79
LH600S-B2	Small Leg Harness with cinch mount	£79
LH600M-B2	Medium Leg Harness with cinch mount	£79
LH600L-B2	Large Leg Harness with cinch mount	£79

### Security covers



Reduced access



Security cover

FS018D-1	Push Button Reduced Access Cover	1-1/2", Ø14mm Hole, Gray	£21
FS019D-1	Push Button Reduced Access Cover	2", Ø14mm Hole, Gray	£21
FS018C-1	Push Button Security Cover	1-1/2", Ø6mm Hole, Gray	£21
FS019C-1	Push Button Security Cover	2", Ø6mm Hole, Gray	£21
FS029C-1	XS Push Button Security Cover	1" PB Buckle	£21

### Mounting options



FrameSaver Clamp



HW303 Shim



Band Clamp



T-slot fastener kit



Flat mount with end fitting kit



Cinch mount



Extention kit



20° Seat Mounting Bracket



90° Seat Mounting Bracket



Shoulder harness strap guide



Strap Guide Mounting Adapter



Plastic cinch mount for MD Series

HW303-B-2	Frame saver (2pk) 22mm Shim, M6 Screw	£9
HW303-B-50	Frame saver (50pk) 22mm Shim, M6 Screw	£185
HW303-19SHIM-2	FrameSaver Shim (2 pk) 19mm	£6
HW320-22-2	Band Clamp (2 pk) 22mm Shim, Stainless steel	£15
HW320-22-10	Band Clamp (10 pk) 22mm Shim, Stainless steel	£60
HW320-25-2	Band Clamp (2 pk) 25mm Shim, Stainless steel	£15
HW320-25-10	Band Clamp (10 pk) 25mm Shim, Stainless steel	£60
HW320-25-50	Band Clamp (50 pk) 25mm Shim, Stainless steel	£290
HW320-30-2	Band Clamp (2 pk) 30mm Shim, Stainless steel	£15
HW320-30-10	Band Clamp (10 pk) 30mm Shim, Stainless steel	£60
HW320-30-50	Band Clamp (50 pk) 30mm Shim, Stainless steel	£290
HKA10-1	T-Slot Fastener Kit (pair) For 10mm T-Slot	£8
HKA10-50	T-Slot Fastener Kit (pk 50) For 10mm T-Slot	£290
HKA1-R-1	End fitting kit (1 pair) 1" Flat mount	£7
HKA1-R-10	End fitting kit (10 pair) 1" Flat mount	£71
HKA1-G-1	End fitting kit (1 pair) 1-1/2" Flat mount	£7
HKA1-G-10	End fitting kit (10 pair) 1-1/2" Flat mount	£71
HKA1-B-1	End fitting kit (1 pair) 2" Flat mount	£7
HKA1-B-10	End fitting kit (10 pair) 2" Flat mount	£71

HKA2-R-1	End fitting kit (1 pair) 1" Cinch mount	£20
HKA2-R-10	End fitting kit (10 pair) 1" Cinch mount	£130
HKA2-R-50	End fitting kit (50 pair) 1" Cinch mount	£712
HKA2-G-1	End fitting kit (1 pair) 1-1/2" Cinch mount	£20
HKA2-G-10	End fitting kit (10 pair) 1-1/2" Cinch mount	£130
HKA2-B-1	End fitting kit (1 pair) 2" Cinch mount	£20
HKA2-B-10	End fitting kit (10 pair) 2" Cinch mount	£130
HKA12-1	Belt mounting extention kit	£17
HW200-90-2	90° Degree Seat Mounting Bracket	£17
HW200-20-2	20° Degree Seat Mounting Bracket	£17
HW100-150-2	Shoulder harness strap guide (pair) 150mm long	£29
HW100-200-2	Shoulder harness strap guide (pair) 200mm long	£29
HW105S-1	Small strap guide mounting adapter	£26
HW105L-1	Large strap guide mounting adapter	£26
HKA32-R-1	Plastic cinch mount (4pk) for MD series	£15

#### PivotFit - New MD series (multi-directional design)



SH290XXS-B6	X-Extra small standard PivotFit with multi-directional design and cinch mount	£95
SH290XS-B6	Extra small standard PivotFit with multi-directional design and cinch mount	£95
SH290S-B6	Small standard PivotFit with multi-directional design and cinch mount	£95
SH290M-B6	Medium standard PivotFit with multi-directional design and cinch mount	£95
SH290L-B6	Large standard PivotFit with multi-directional design and cinch mount	£95
SH290XL-B6	Extra large standard PivotFit with multi-directional design and cinch mount	£95
SH295XXS-B6	X-Extra small dynamic PivotFit with multi-directional design and cinch mount	£99
SH295XS-B6	Extra small dynamic PivotFit with multi-directional design and cinch mount	£99
SH295S-B6	Small dynamic PivotFit with multi-directional design and cinch mount	£99
SH295M-B6	Medium dynamic PivotFit with multi-directional design and cinch mount	£99
SH295L-B6	Large dynamic PivotFit with multi-directional design and cinch mount	£99
SH295XL-B6	Extra large dynamic PivotFit with multi-directional design and cinch mount	£99

#### Trimline - New MD series (multi-directional design)



SH235S-B6	Small Trimline shoulder harness with multi-directional straps and cinch mount	£80
SH235M-B6	Medium Trimline shoulder harness with multi-directional straps and cinch mount	£80
SH235L-B6	Large Trimline shoulder harness with multi-directional straps and cinch mount	£80

#### Stayflex - New MD series (multi-directional design)

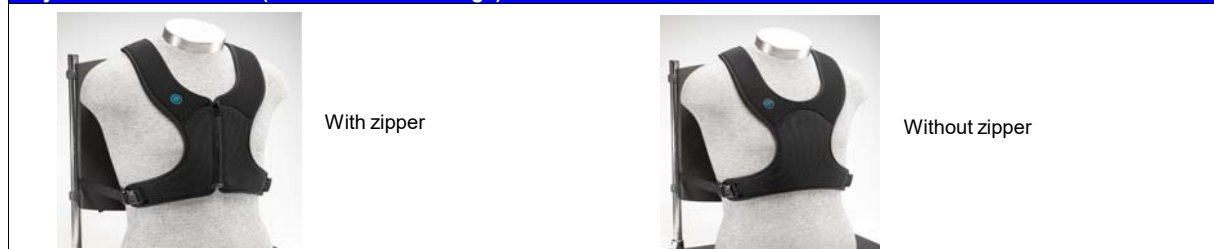

SH350M-B6	Medium standard Stayflex with zip, with multifunctional straps and plastic cinch mounts	£115
SH350L-B6	Large standard Stayflex with zip, with multifunctional straps and plastic cinch mounts	£115
SH351XS-B6	Extra small standard Stayflex without zip, with multidirectional straps and plastic cinch mounts	£115
SH351S-B6	Small standard Stayflex without zip, with multidirectional straps and plastic cinch mounts	£115
SH360M-B6	Medium narrow Stayflex with zip, with multidirectional straps and cinch mounts	£115
SH360L-B6	Large narrow Stayflex with zip, with multidirectional straps and cinch mounts	£115
SH360XL-B6	Extra large narrow Stayflex with zip, with multidirectional straps and cinch mounts	£115
SH361M-B6	Medium narrow Stayflex without zip, with multidirectional straps and cinch mount	£115
SH361L-B6	Large narrow Stayflex without zip, with multidirectional straps and cinch mount	£115
SH361XL-B6	Extra large narrow Stayflex without zip, with multidirectional straps and cinch mount	£115

**Monoflex**



SH120 Underarm release



SH122 Centre release

SH120XS-B3	Extra Small, front pull, grommet strap	£66
SH120S-B3	Small, front pull, grommet Strap	£66
SH120M-B3	Medium, front pull, grommet strap	£66
SH120L-B3	Large, front pull, grommet Strap	£66
SH120XL-B3	X-Large, front pull, grommet strap	£66
SH120XS-B1	Extra Small, Monoflex underarm release, flat mount	£66
SH120S-B1	Small, Monoflex underarm release, flat mount	£66
SH120M-B1	Medium, Monoflex underarm release, flat mount	£66
SH120L-B1	Large, Monoflex underarm release, flat mount	£66
SH120XL-B1	Extra Large, Monoflex underarm release, flat mount	£66
SH122XS-B1	Extra-small Monflex centre release, flat mount	£66
SH122S-B1	Small Monflex centre release, flat mount	£66
SH122M-B1	Medium Monflex centre release, flat mount	£66
SH122L-B1	Large Monflex centre release, flat mount	£66
SH122XL-B1	Extra-large Monflex centre release, flat mount	£66

**Universal elastic straps**



SP110S	Small - Length 142cm (56 in), Width 75mm (3 in)	£60
SP110L	Large - Length 142cm (56 in), Width 11cm (4-1/2 in)	£60
SP110XL	Extra large - Length 142cm (56 in), Width 15cm (6 in)	£60

**Ankle hugger**



Ankle huggers

FT240XS	X-Small ankle huggers with adjustment mount	£99
FT240S	Small ankle huggers with adjustment mount	£99
FT240M	Medium ankle huggers with adjustment mount	£99
FT240L	Large ankle huggers with adjustment mount	£99
FT240XL	X-Large ankle huggers with adjustment mount	£99
FT200AS-1	Spare 1" footman loop adjustable mounting kit	£24

**Aeromesh**



Calf strap



Calf panel

SP102S	Small, 32" calf strap	£49
SP102M	Medium, 36" calf strap	£49
SP102L	Large, 40" calf strap	£49
SP103S	Small, 32-1/2" calf panel	£65
SP103M	Medium, 35-1/2" calf panel	£65
SP103L	Large, 38-1/2" calf panel	£65

**Joystick handles**



U-Shape  
PC101/2



Rubber dome  
PC107



Grooved Mushroom  
PC110

PC101A	3" wide U-shaped	Fits stem size 4.8mm (3/16 in)	£57
PC102A	4" wide U-shaped	Fits stem size 4.8mm (3/16 in)	£57
PC107A	Wide Rubber Dome	Fits stem size 4.8mm (3/16 in)	£57
PC110A	Grooved Mushroom (Height can be cut to size: 28-60mm)	Fits stem size 4.8mm (3/16 in)	£57

Mobility bag











SP001	Bodypoint mobility bag	£47
-------	------------------------	-----



Tel: 01656 776222 Fax: 01656 776220  
Email: ordersuk@invacare.com  
www.invacare.co.uk









Pro-tech belts & harnesses  
**April 2020**

<b>Pro-tech Wheelchair Back System - Dynamic Anti-Thrust Harness</b>				
Model	Description	Part Number	UOM	Net Price
	Dynamic Anti Thrust Harness Small	1525269	EA	£124
	Dynamic Anti Thrust Harness Medium	1525270	EA	£124
	Dynamic Anti Thrust Harness Large	1525271	EA	£124
	Dynamic Anti Thrust Harness Extra Large	1525272	EA	£124
<b>Pro-tech Wheelchair Back System - Dynamic Harness</b>				
	Dynamic Harness Small	1525278	EA	£94
	Dynamic Harness Medium	1525279	EA	£94
	Dynamic Harness Large	1525280	EA	£94
<b>Pro-tech Wheelchair Back System - Shoulder Harness</b>				
	Shoulder Harness Small	1525273	EA	£94
	Shoulder Harness Medium	1525274	EA	£94
	Shoulder Harness Large	1525275	EA	£94
<b>Pro-tech Wheelchair Back System - Sternum Harness</b>				
	Sternum Harness Medium	1525276	EA	£78
	Sternum Harness Large	1525277	EA	£78
<b>Pro-tech Wheelchair Back System - Y-Style Harness</b>				
	Y-Style Harness Small	1525281	EA	£90
	Y-Style Harness Medium	1525282	EA	£90
	Y-Style Harness Large	1525283	EA	£90
<b>Pro-tech Wheelchair Back System - Dynamic Chest Support</b>				
	Dynamic Chest Support Medium	1525284	EA	£71
	Dynamic Chest Support Large	1525285	EA	£71
<b>Pro-tech Wheelchair Back System - Fixing Kits</b>				
	Tri-Slot Mounting Plates (25mm)	1525286	PR	£2.31
	Tri-Slot Mounting Plates (40mm)	1525287	PR	£2.31
	Frame Clamp (19mm, 22mm & 25mm)	1525288	EA	£4.73

Order No :  
Customer Ref :

Pro-tech belts & harnesses  
1 of 3



Subject to Invacare's standard terms and conditions.  
Invacare reserves the right to alter product specification without prior notice

<b>Pro-tech Pelvic Belts</b>				
<b>All belts in this range as standard, have neoprene comfort pads, and are supplied with Triple Mounting Plates and Frame Clamps to suit 19mm, 22mm &amp; 25mm tube sizes</b>				
Model	Description	Part Number	UOM	Net Price
	Padded Four Point belt with dual pull tight Plastic Squeeze Buckle	1525292	EA	£62
	Padded Pull tight belt with dual pull tight Plastic Buckle	1525293	EA	£59
	Padded Single pull belt with twin lock Plastic Buckle	1525294	EA	£59
	Padded Four Point single pull pediatric belt with twin lock Plastic Buckle	1525295	EA	£62
<b>Pro-tech Wheelchair Back System - Seat Belts</b>				
	Padded single pull pelvic belt with Auto Style Release	1525289	EA	£64
	Padded dual pull pelvic belt with Plastic Squeeze Buckle	1525290	EA	£64
	Rear dual pull padded pelvic belt with Plastic Squeeze Buckle	1525296	EA	£64
	Padded four point dual pull pelvic belt with Plastic Squeeze Buckle	1525291	EA	£66
	Padded four point single pull pelvic belt with Auto Style Release	1525297	EA	£78



Tel: 01656 776222 Fax: 01656 776220  
Email: ordersuk@invacare.com  
www.invacare.co.uk

Pro-tech belts & harnesses  
**April 2020**

Pro-tech Wheelchair Back System - Strap Risers				
Model	Description	Part Number	UOM	Net Price
	2 x 25 Degree Strap Risers	1498447	PR	£24
Pro-tech Wheelchair Back System - High Tops including Fixings				
	Hi Tops Extra Small	1525298	PR	£102
	Hi Tops Small	1525299	PR	£102
	Hi Tops Medium	1525300	PR	£102
	Hi Tops Large	1525301	PR	£102
	Hi Tops Extra Large	1525302	PR	£102
Pro-tech Wheelchair Back System - Foot Supports including Fixings				
	Shoeholders Small	1496425	PR	£149
	Shoeholders Small/Medium	1496426	PR	£149
	Shoeholders Medium/Large	1496905	PR	£149
	Shoeholders Large	1496906	PR	£149
	Shoeholders X-Large	1496936	PR	£149





Yes, you can.®

Tel: 01656 776222 Fax: 01656 776220

Email: ordersuk@invacare.com

www.invacare.co.uk

**RETAIL PRICELIST**

Pro-tech spares

April 2020

Pro-tech Wheelchair Back System - Back Shells				
	12" Standard	1497009	EA	£402
	14" Standard	1497042	EA	£402
	16" Standard	1497043	EA	£402
	18" Standard	1497044	EA	£402
	20" Standard	1497145	EA	£402
	22" Standard	1497146	EA	£402
	24" Standard	1497147	EA	£402
	12" Tall	1497185	EA	£402
	14" Tall	1497186	EA	£402
	16" Tall	1497187	EA	£402
18" Tall	1497208	EA	£402	
20" Tall	1497316	EA	£402	
Pro-tech Wheelchair Back System - Backrest Hardware Kits				
	7/8" Backrest Hardware Kit to fit 12" - 14" Shell	1497781	EA	£272
	1" Backrest Hardware Kit to fit 12" - 14" Shell	1497782	EA	£272
	7/8" Backrest Hardware Kit to fit 16" - 24" Shell	1497536	EA	£272
	1" Backrest Hardware Kit to fit 16" - 24" Shell	1497537	EA	£272
Pro-tech Wheelchair Back System - Deep Contour Fins & Fixings				
	12" Deep Contour Lateral Fins & Fixings	1493865 1494012	PR	£89
	14" Deep Contour Lateral Fins & Fixings		PR	£89
	16" Deep Contour Lateral Fins & Fixings	1494013 1494014	PR	£89
	18" Deep Contour Lateral Fins & Fixings		PR	£89
	20" Deep Contour Lateral Fins & Fixings	1494015	PR	£89
	22" Deep Contour Lateral Fins & Fixings	1494016	PR	£89
Pro-tech Wheelchair Back System - Standard Cushions				
Model	Description	Part Number	UOM	Net Price
	12" Standard	PRPSC12	EA	£100
	14" Standard	PRPSC14	EA	£100
	16" Standard	PRPSC16	EA	£100
	18" Standard	PRPSC18	EA	£100
	20" Standard	PRPSC20	EA	£100
	22" Standard	PRPSC22	EA	£100
24" Standard	PRPSC24	EA	£100	
Pro-tech Wheelchair Back System - Standard Cushion Foams Only				
	12" Standard	PRPSCSH12	EA	£49
	14" Standard	PRPSCSH14	EA	£49
	16" Standard	PRPSCSH16	EA	£49
	18" Standard	PRPSCSH18	EA	£49
	20" Standard	PRPSCSH20	EA	£49
	22" Standard	PRPSCSH22	EA	£49
24" Standard	PRPSCSH24	EA	£49	
Pro-tech Wheelchair Back System - Standard Cushion Covers Only				
	12" Standard	PRPSCOV12	EA	£57
	14" Standard	PRPSCOV14	EA	£57
	16" Standard	PRPSCOV16	EA	£57
	18" Standard	PRPSCOV18	EA	£57
	20" Standard	PRPSCOV20	EA	£57
	22" Standard	PRPSCOV22	EA	£57
24" Standard	PRPSCOV24	EA	£57	
Pro-tech Wheelchair Back System - Tall Cushions				
	12" Tall	PRPTC12	EA	£107
	14" Tall	PRPTC14	EA	£107
	16" Tall	PRPTC16	EA	£107
	18" Tall	PRPTC18	EA	£107
	20" Tall	PRPTC20	EA	£107

Order No :  
Customer Ref :

Pro-tech Spares  
1 of 14

Subject to Invacare's standard terms and conditions.  
Invacare reserves the right to alter product specification without prior notice



Yes, you can.™

Tel: 01656 776222 Fax: 01656 776220



Email: ordersuk@invacare.com

www.invacare.co.uk

**RETAIL PRICELIST**

Pro-tech spares

**April 2020**

Pro-tech Wheelchair Back System - Tall Cushion Foams Only				
	12" Tall	PRPTCSH12	EA	£53
	14" Tall	PRPTCSH14	EA	£53
	16" Tall	PRPTCSH16	EA	£53
	18" Tall	PRPTCSH18	EA	£53
	20" Tall	PRPTCSH20	EA	£53
Pro-tech Wheelchair Back System - Tall Cushion Covers Only				
	12" Tall	PRPTCOV12	EA	£61
	14" Tall	PRPTCOV14	EA	£61
	16" Tall	PRPTCOV16	EA	£61
	18" Tall	PRPTCOV18	EA	£61
	20" Tall	PRPTCOV20	EA	£61
Pro-tech Wheelchair Back System - Standard Deep Contour Cushions				
Model	Description	Part Number	UOM	Net Price
	12" Standard Deep Contour	PRPSC12DC	EA	£107
	14" Standard Deep Contour	PRPSC14DC	EA	£107
	16" Standard Deep Contour	PRPSC16DC	EA	£107
	18" Standard Deep Contour	PRPSC18DC	EA	£107
	20" Standard Deep Contour	PRPSC20DC	EA	£107
	22" Standard Deep Contour	PRPSC22DC	EA	£107
	24" Standard Deep Contour	PRPSC24DC	EA	£107
Pro-tech Wheelchair Back System- Standard Deep Contour Foam Only				
	12" Standard Deep Contour	PRPSCSH12DC	EA	£49
	14" Standard Deep Contour	PRPSCSH14DC	EA	£49
	16" Standard Deep Contour	PRPSCSH16DC	EA	£49
	18" Standard Deep Contour	PRPSCSH18DC	EA	£49
	20" Standard Deep Contour	PRPSCSH20DC	EA	£49
	22" Standard Deep Contour	PRPSCSH22DC	EA	£49
	24" Standard Deep Contour	PRPSCSH24DC	EA	£49
Pro-tech Wheelchair Back System - Standard Deep Contour Covers Only				
	12" Standard Deep Contour	PRPSCOV12DC	EA	£57
	14" Standard Deep Contour	PRPSCOV14DC	EA	£57
	16" Standard Deep Contour	PRPSCOV16DC	EA	£57
	18" Standard Deep Contour	PRPSCOV18DC	EA	£57
	20" Standard Deep Contour	PRPSCOV20DC	EA	£57
	22" Standard Deep Contour	PRPSCOV22DC	EA	£57
	24" Standard Deep Contour	PRPSCOV24DC	EA	£57
Pro-tech Wheelchair Back System - Tall Deep Contour Cushions				
	12" Tall Deep Contour	PRPTC12DC	EA	£111
	14" Tall Deep Contour	PRPTC14DC	EA	£111
	16" Tall Deep Contour	PRPTC16DC	EA	£111
	18" Tall Deep Contour	PRPTC18DC	EA	£111
	20" Tall Deep Contour	PRPTC20DC	EA	£111
Pro-tech Wheelchair Back System- Tall Deep Contour Foam Only				
	12" Tall Deep Contour	PRPTCSH12DC	EA	£53
	14" Tall Deep Contour	PRPTCSH14DC	EA	£53
	16" Tall Deep Contour	PRPTCSH16DC	EA	£53
	18" Tall Deep Contour	PRPTCSH18DC	EA	£53
	20" Tall Deep Contour	PRPTCSH20DC	EA	£53
Pro-tech Wheelchair Back System - Tall Deep Contour Cushion Covers Only				
	12" Tall Deep Contour	PRPTCOV12DC	EA	£61
	14" Tall Deep Contour	PRPTCOV14DC	EA	£61
	16" Tall Deep Contour	PRPTCOV16DC	EA	£61
	18" Tall Deep Contour	PRPTCOV18DC	EA	£61
	20" Tall Deep Contour	PRPTCOV20DC	EA	£61

Tel: 01656 776222 Fax: 01656 776220

Email: ordersuk@invacare.com

www.invacare.co.uk

<b>Pro-tech Wheelchair Back System - Aluminium L Brackets</b>				
Model	Description	Part Number	UOM	Net Price
	1 x L Bracket 4" x 2" to Fit 12" shell	1503893	EA	£28
	1 x L Bracket 4 1/2" x 2" to fit 14" shell	1503889	EA	£28
	1 x L Bracket 6" x 3" to fit 16-20" back	1497624	EA	£28
	1 x L Bracket 6" x 4" to fit hip guides	1496350	EA	£28
	1 x L Bracket 3" x 2" to fit 12" shell to 10" chair	1522554	EA	£28
	Steel L Bracket 3" x 1 1/2"	1522833-0205	EA	£28
	Steel L Bracket 4 1/2" x 1 1/2"	1522834-0205	EA	£28
	Steel L Bracket 6" x 2"	1522835-0205	EA	£28
<b>Pro-tech Wheelchair Back System - Aluminium Easy Clamps with L Brackets</b>				
	1 x Aluminium Easy Clamp & 6" x 3" L Bracket to fit 7/8" Tube	1504223	EA	£67
	1 x Aluminium Easy Clamp & 6" x 3" L Bracket to fit 1" Tube	1504224	EA	£67
<b>Pro-tech Wheelchair Back System - Tension Hooks</b>				
	1 x 7/8" Tension Hook	1497538	EA	£4.83
	1 x 1" Tension Hook	1497611	EA	£4.83
<b>Pro-tech Wheelchair Back System - Easy Clamps</b>				
	1 x Aluminium Easy Clamp to fit 7/8" Tube	1509760	EA	£32
	1 x Aluminium Easy Clamp to fit 1" Tube	1509761	EA	£32
	1 x Plastic Easy Clamp to fit 7/8" Tube	1497613	EA	£23
	1 x Plastic Easy Clamp to fit 1" Tube	1497623	EA	£23
<b>Pro-tech Wheelchair Back System - U Clamp</b>				
	1 x Plastic U Clamp	1497625	EA	£9.82
<b>Pro-tech Wheelchair Back System - Stopper</b>				
	1 x Plastic Stopper	1497632	EA	£1.21
<b>Pro-tech Wheelchair Back System- Reinforcement Plate</b>				
	Reinforcement Plate 16"	1522555	EA	£56
	Reinforcement Plate 18"	1522556	EA	£56
	Reinforcement Plate 20"	1522557	EA	£56
<b>Pro-tech Wheelchair Back System- Hip Guides - Offset Bracket</b>				
	1 x 1" / 2.5cm Offset Bracket for Hip Guides	1496351	EA	£56



Yes, you can.™

Tel: 01656 776222 Fax: 01656 776220







Email: ordersuk@invacare.com

www.invacare.co.uk

**RETAIL PRICELIST**

Pro-tech spares

**April 2020**

<b>Pro-tech Wheelchair Back System - Screw Pack A</b>				
Model	Description	Part Number	UOM	Net Price
	Screw Pack A - Consisting of 8 x 1" weld nuts, 4 x 2" weld nuts, 2 x single weld nuts, 12 x 5/8 dome heads, 12 x 7/8" dome heads, 8 x 3/4" dome heads, 44 x washers, 2 x stoppers, 2 x U-Clamps, 2 x 1" tension hooks, 2 x 7/8" tension hooks, 2 x 1" easy clamps, 2 x 7/8" easy clamps.	1503884	EA	£122
<b>Pro-tech Wheelchair Back System- Screw Pack B</b>				
	Screw Pack B - Consisting of 8 x 1" weld nuts, 4 x 2" weld nuts, 2 x single weld nuts, 12 x 5/8 dome heads, 12 x 7/8" dome heads, 8 x 3/4" dome heads, 44 x washers.	1503885	EA	£15.00
<b>Pro-tech Wheelchair Back System - Slide Tracks</b>				
<b>Optional, Facilitates vertical adjustment of lateral supports. Fits to back shell</b>				
	5" / 12.7cm Slide Track 7" / 17.8cm Slide Track 9" / 22.8cm Slide Track	1503890 1503891 1503892	PR PR PR	£45 £45 £45
<b>Pro-tech Wheelchair Back System - Screws/Washers</b>				
	Pack of 50 - 3/4" Countersunk Screws	1504237	PK	£8.66
	Pack of 50 - 1" Buttonhead Screws	1504236	PK	£8.66
	Pack of 50 - 7/8" Buttonhead Screws	1504233	PK	£8.66
	Pack of 50 - 3/4" Buttonhead Screws	1504235	PK	£8.66
	Pack of 50 - 5/8" Buttonhead Screws	1504234	PK	£8.66
	Pack of 100 1/4" Washers	1511267	PK	£15.75
<b>Pro-tech Wheelchair Back System - Weld Nuts</b>				
	1 x 1" Weld Nut	1497641	EA	£1.31
	1 x 2" Weld Nut	1504303	EA	£1.31
	Pack of 50 - 1" Weld Nuts	1511268	PK	£63.00
	Pack of 25 - 2" Weld Nuts	1511269	PK	£31.50
<b>Pro-tech Wheelchair Back System - Complete Standard Stem &amp; Occipital Headrest Pad</b>				
Model	Description	Part Number	UOM	Net Price
	Standard Rock & Roll Headrest fitted with Small Occipital headrest pad	1504017	EA	£297
	Standard Rock & Roll Headrest fitted with Medium Occipital headrest pad	1504018	EA	£297
	Standard Rock & Roll Headrest fitted with Large Occipital headrest pad	1504019	EA	£297

Order No :  
Customer Ref :



Yes, you can.™

Tel: 01656 776222 Fax: 01656 776220

Email: ordersuk@invacare.com

www.invacare.co.uk

**RETAIL PRICELIST**

Pro-tech spares

**April 2020**

Pro-tech Wheelchair Back System - Complete Standard Stem & Slimline Headrest Pad				
	Standard Rock & Roll Headrest fitted with Small Slimline headrest pad	1504020	EA	£287
	Standard Rock & Roll Headrest fitted with Medium Slimline headrest pad	1504021	EA	£287
	Standard Rock & Roll Headrest fitted with Large Slimline headrest pad	1504022	EA	£287
Pro-tech Wheelchair Back System - Complete Standard Stem & Soft Headrest Pad				
	Standard Rock & Roll Headrest fitted with Small Soft headrest pad	1504023	EA	£297
	Standard Rock & Roll Headrest fitted with Medium Soft headrest pad	1504024	EA	£297
	Standard Rock & Roll Headrest fitted with Large Soft headrest pad	1504025	EA	£297
Pro-tech Wheelchair Back System - Complete Standard Stem & Tri-Pad Headrest Pad				
	Standard Rock & Roll Headrest fitted with Medium Tri-Pad headrest pad	1504026	EA	£399
	Standard Rock & Roll Headrest fitted with Large Tri-Pad headrest pad	1504027	EA	£399
Pro-tech Wheelchair Back System - Complete Flip Down Stem & Occipital Headrest Pad				
Model	Description	Part Number	UOM	Net Price
	Flip Down Rock & Roll Headrest fitted with Small Occipital headrest pad	1504028	EA	£342
	Flip Down Rock & Roll Headrest fitted with Medium Occipital headrest pad	1504029	EA	£342
	Flip Down Rock & Roll Headrest fitted with Large Occipital headrest pad	1504030	EA	£342
Pro-tech Wheelchair Back System - Complete Flip Down Stem & Slimline Headrest Pad				
	Flip Down Rock & Roll Headrest fitted with Small Slimline headrest pad	1504031	EA	£331
	Flip Down Rock & Roll Headrest fitted with Medium Slimline headrest pad	1504032	EA	£331
	Flip Down Rock & Roll Headrest fitted with Large Slimline headrest pad	1504033	EA	£331
Pro-tech Wheelchair Back System - Complete Flip Down Stem & Soft Headrest Pad				
	Flip Down Rock & Roll Headrest fitted with Small Soft headrest pad	1504034	EA	£341
	Flip Down Rock & Roll Headrest fitted with Medium Soft headrest pad	1504035	EA	£341
	Flip Down Rock & Roll Headrest fitted with Large Soft headrest pad	1504036	EA	£341

Order No :  
Customer Ref :

Pro-tech Spares  
5 of 14

Subject to Invacare's standard terms and conditions.  
Invacare reserves the right to alter product specification without prior notice



Yes, you can.®

Tel: 01656 776222 Fax: 01656 776220





Email: ordersuk@invacare.com

www.invacare.co.uk

**RETAIL PRICELIST**

Pro-tech spares

**April 2020**

Pro-tech Wheelchair Back System - Complete Flip Down Stem & Tri-Pad Headrest Pad				
	Flip Down Rock & Roll Headrest fitted with Medium Tri-Pad headrest pad	1504037	EA	£443
	Flip Down Rock & Roll Headrest fitted with Large Tri-Pad headrest pad	1504038	EA	£443
Pro-tech Wheelchair Back System - Occipital Headrest Pad				
An adapter plate is included if the headrest hardware requires the 10-32 screw mounting				
Model	Description	Part Number	UOM	Net Price
	Small Occipital headrest pad	1493458	EA	£110
	Medium Occipital headrest pad	1493459	EA	£110
	Large Occipital headrest pad	1493460	EA	£110
Pro-tech Wheelchair Back System - Slimline Headrest Pad				
An adapter plate is included if the headrest hardware requires the 10-32 screw mounting				
	Small Slimline headrest pad	1493461	EA	£101
	Medium Slimline headrest pad	1493462	EA	£101
	Large Slimline headrest pad	1493463	EA	£101
Pro-tech Wheelchair Back System - Soft Headrest Pad				
An adapter plate is included if the headrest hardware requires the 10-32 screw mounting				
	Small Soft headrest pad	1493464	EA	£110
	Medium Soft headrest pad	1493473	EA	£110
	Large Soft headrest pad	1493474	EA	£110
Pro-tech Wheelchair Back System - Tri-Pad Headrest Pad				
An adapter plate is included if the headrest hardware requires the 10-32 screw mounting				
	Medium Tri-Pad headrest pad	1493475	EA	£212
	Large Tri-Pad headrest pad	1493574	EA	£212



Pro-tech Wheelchair Back System - Standard Rock & Roll Headrest Stem				
Model	Description	Part Number	UOM	Net Price
	Standard Rock & Roll Headrest Stem	1493575	EA	£188
Pro-tech Wheelchair Back System - Flip Down Rock & Roll Headrest Stem				
	Flip Down Rock & Roll Headrest Stem	1493576	EA	£232
Pro-tech Wheelchair Back System - Headrest Adapter Plate for Third Party Headrests				
	Headrest Adaptor Plate for Third Party Headrests (Mounts inside back shell)	1503916	EA	£80
Pro-tech Wheelchair Back System - Curved Lateral Pads to fit Old Style Bracket (Pair)				
Small Curved Pad Size - 5" L x 3" W x 3/4" D / 12.7cm L x 7.6cm W x 2cm D Medium Curved Pad Size - 6" L x 4" W x 3/4" D / 15.2cm L x 10.2cm W x 2cm D Large Curved Pad Size - 7" L x 5" W x 3/4" D / 17.8cm L x 12.7cm W x 2cm D				
	Small Curved Pad to fit Old Style Swingaway Bracket complete with 10/32" Screws	1494024	PR	£62
	Medium Curved Pad to fit Old Style Swingaway Bracket complete with 10/32" Screws	1494025	PR	£62
	Large Curved Pad to fit Old Style Swingaway Bracket complete with 10/32" Screws	1494026	PR	£62
Pro-tech Wheelchair Back System - Fixed Lateral Brackets with D Pads (Pair)				
Model	Description	Part Number	UOM	Net Price
	Fixed Lateral Hardware, complete with Small D Pad (To fit 12-14" Back Shell)	1494029	PR	£188
	Fixed Lateral Hardware, complete with Large D Pad (To fit 16-20" Back Shell)	1494030	PR	£188
Pro-tech Wheelchair Back System - Lift & Swingaway Lateral Brackets with Curved Pads (Pair)				
	Lift & Swingaway Lateral Hardware complete with Small Curved Pads	1494031	PR	£343
	Lift & Swingaway Lateral Hardware complete with Medium Curved Pads	1494032	PR	£343
	Lift & Swingaway Lateral Hardware complete with Large Curved Pads	1494033	PR	£343



Yes, you can.™

Tel: 01656 776222 Fax: 01656 776220

Email: ordersuk@invacare.com

www.invacare.co.uk

**RETAIL PRICELIST**

Pro-tech spares

**April 2020**

Pro-tech Wheelchair Back System - Lift & Swingaway Lateral Bracket with D Pads (Pair)				
	Lift & Swingaway Lateral Hardware, complete with Small D Pad	1495224	PR	£343
	Lift & Swingaway Lateral Hardware, complete with Large D Pad	1495225	PR	£343
Pro-tech Wheelchair Back System - D Lateral Pads (Pair)				
Small D Pad Size - 4 1/2" L x 1/2" W x 4" D / 11.4cm L x 1.3cm W x 10.2cm D Large D Pad Size - 6" L x 1/2" W x 5" D / 15.2cm L x 1.3cm W x 12.7cm D				
	Small D Pad to fit Lift & Swingaway and Fixed Lateral Bracket	1494017	PR	£62
	Large D Pad to fit Lift & Swingaway and Fixed Lateral Bracket	1494018	PR	£62
	Small D Pad to fit Push Button Lateral Bracket	1494019	PR	£62
	Large D Pad to fit Push Button Lateral Bracket	1494020	PR	£62
Pro-tech Wheelchair Back System - Curved Lateral Pads (Pair)				
Small Curved Pad Size - 5" L x 3" W x 3/4" D / 12.7cm L x 7.6cm W x 2cm D Medium Curved Pad Size - 6" L x 4" W x 3/4" D / 15.2cm L x 10.2cm W x 2cm D Large Curved Pad Size - 7" L x 5" W x 3/4" D / 17.8cm L x 12.7cm W x 2cm D				
	Small Curved Pad to fit Lift & Swingaway Lateral	1494021	PR	£62
	Medium Curved Pad to fit Lift & Swingaway Lateral	1494022	PR	£62
	Large Curved Pad to fit Lift & Swingaway Lateral	1494023	PR	£62
Pro-tech Wheelchair Back System - Hip/Thigh Guide Spacers				
	1/2" / 1.3cm Spacers	1495286	PR	£6.09
	1/4" / 0.6cm Spacers	1495287	PR	£6.09
Pro-tech Wheelchair Back System - Lateral Brackets Only (Pair)				
Model	Description	Part Number	UOM	Net Price
	Fixed Lateral Bracket Small (To fit 12" - 14" Back Shell)	1494027	PR	£71
	Fixed Lateral Bracket Large (To fit 16" - 24" Shell)	1503917	PR	£71
Pro-tech Wheelchair Back System - Lift & Swingaway Lateral Bracket Small				
	Lift & Swingaway Lateral Bracket Small (Left) (To fit 12" - 14" Shell)	1503918	LH	£152
	Lift & Swingaway Lateral Bracket Small (Right) (To fit 12" - 14" Shell)	1503919	RH	£152
	Lift & Swingaway Lateral Brackets Small (Pair) (To fit 12" - 14" Shell)	1504001	PR	£306
Pro-tech Wheelchair Back System - Lift & Swingaway Lateral Bracket Large				
	Lift & Swingaway Lateral Bracket Large (Left) (To fit 16" - 24" Shell)	1503999	LH	£152
	Lift & Swingaway Lateral Bracket Large (Right) (To fit 16" - 24" Shell)	1504000	RH	£152
	Lift & Swingaway Lateral Brackets Large (Pair) (To fit 16" - 24" Shell)	1504002	PR	£306



Yes, you can.™

Tel: 01656 776222 Fax: 01656 776220

Email: ordersuk@invacare.com

www.invacare.co.uk

**RETAIL PRICELIST**

Pro-tech spares

**April 2020**

Pro-tech Wheelchair Back System - Lateral D Pad Removable Covers				
	D Pad Removable Covers - Small	1495226	PR	£48
	D Pad Removable Covers - Large	1495227	PR	£72
Pro-tech Wheelchair Back System - Lateral Curved Pad Removable Covers				
	Curved Pad Removable Covers - Small	1495228	PR	£48
	Curved Pad Removable Covers - Medium	1495229	PR	£59
	Curved Pad Removable Covers - Large	1495230	PR	£72
Pro-tech Wheelchair Back System - Abductors with Std Track & Pad				
Model	Description	Part Number	UOM	Net Price
	Flip Down Abductor, fitted with 3" Standard Track and Small Pad	1495674	EA	£312
	Flip Down Abductor, fitted with 3" Standard Track and Medium Pad	1495723	EA	£312
	Flip Down Abductor, fitted with 3" Standard Track and Large Pad	1495724	EA	£312
	Flip Down Abductor, fitted with 3" Standard Track and Xtra Large Pad	1495744	EA	£312
Pro-tech Wheelchair Back System - Abductors with Extended Track & Pad				
	Flip Down Abductor, fitted with 5" Extended Track and Small Pad	1495745	EA	£312
	Flip Down Abductor, fitted with 5" Extended Track and Medium Pad	1495746	EA	£312
	Flip Down Abductor, fitted with 5" Extended Track and Large Pad	1495788	EA	£312
	Flip Down Abductor, fitted with 5" Extended Track and Xtra Large Pad	1495917	EA	£312
Pro-tech Wheelchair Back System - Abductor Brackets Only				
	Flip Down Abductor Bracket - Standard (3" / 7.6cm height)	1503920	EA	£171
	Flip Down Abductor Bracket - Extended (5" / 12.7cm height)	1503921	EA	£171
	Abductor Pad Mounting Bracket only - Standard (3" / 7.6cm height)	1495624	EA	£52
	Abductor Pad Mounting Bracket only - Extended (5" / 12.7cm height)	1495636	EA	£52

Order No :  
Customer Ref :

Pro-tech Spares  
9 of 14

Subject to Invacare's standard terms and conditions.  
Invacare reserves the right to alter product specification without prior notice



Yes, you can.™

Tel: 01656 776222 Fax: 01656 776220

Email: ordersuk@invacare.com

www.invacare.co.uk

**RETAIL PRICELIST**

Pro-tech spares

**April 2020**

Pro-tech Wheelchair Back System - Abductor Pads Only				
	Abductor Pad - Small	1495288	EA	£143
	Abductor Pad - Medium	1495321	EA	£143
	Abductor Pad - Large	1495622	EA	£143
	Abductor Pad - Extra Large	1495623	EA	£143
Pro-tech Wheelchair Back System - Knee Adductors				
Model	Description	Part Number	UOM	Net Price
	Knee Adductor LH to fit 7/8" / 2.2cm Tube	1504135	LH	£200
	Knee Adductor RH to fit 7/8" 2.2cm Tube	1504136	RH	£200
	Knee Adductor LH to fit 1" / 2.54cm Tube	1504137	LH	£200
	Knee Adductor RH to fit 1" / 2.54cm Tube	1504138	RH	£200
	Knee Adductors 7/8" / 2.22cm	1495918	PR	£400
	Knee Adductors 1" / 2.54cm	1495919	PR	£400
Pro-tech Wheelchair Back System - Knee Adductor Removable Covers				
	Knee Adductor - Removable Covers	1495920	PR	£44
Pro-tech Wheelchair Back System - Hip/Thigh Guides - Complete Assy RH/LH				
	Hip/Thigh Guides with Small Slimline Pad	1495931	PR	£187
	Hip/Thigh Guides with Medium Slimline Pad	1495932	PR	£187
	Hip/Thigh Guides with Large Slimline Pad	1495933	PR	£187
	Hip/Thigh Guides with Small Standard Pad	1503877	PR	£187
	Hip/Thigh Guides with Medium Standard Pad	1503879	PR	£187
	Hip/Thigh Guides with Large Standard Pad	1503880	PR	£187
Pro-tech Wheelchair Back System - Hip/Thigh Guides 1" Offset Bracket - Complete Assy RH/LH				
	Hip/Thigh Guides - 1"/2.5cm offset Small Slimline Pad	1496061	PR	£187
	Hip/Thigh Guides - 1"/2.5cm offset Medium Slimline Pad	1496062	PR	£187
	Hip/Thigh Guides - 1"/2.5cm offset Large Slimline Pad	1406093	PR	£187
	Hip/Thigh Guides - 1"/2.5cm offset Small Standard Pad	1503881	PR	£187
	Hip/Thigh Guides - 1"/2.5cm offset Medium Standard Pad	1503882	PR	£187
	Hip/Thigh Guides - 1"/2.5cm offset Large Standard Pad	1503883	PR	£187



Yes, you can.™

Tel: 01656 776222 Fax: 01656 776220



Email: ordersuk@invacare.com

www.invacare.co.uk

**RETAIL PRICELIST**

Pro-tech spares

**April 2020**

<b>Pro-tech Wheelchair Back System - Hip/Thigh Guide Removable Covers</b>				
Model	Description	Part Number	UOM	Net Price
	Hip Thigh Guide Removable Covers for the Slimline pad - Small	1496219	PR	£44
	Hip Thigh Guide Removable Covers for the Slimline pad - Medium	1496220	PR	£53
	Hip Thigh Guide Removable Covers for the Slimline pad - Large	1496349	PR	£65
	Hip Thigh Guide Removable Covers for the Standard pad - Small	1503886	PR	£44
	Hip Thigh Guide Removable Covers for the Standard pad - Medium	1503887	PR	£53
	Hip Thigh Guide Removable Covers for the Standard pad - Large	1503888	PR	£65
<b>Pro-tech Wheelchair Back System - Hip/Thigh Guide Slimline - Pad Only</b>				
Small Hip Guide Pad Size - 6" L x 1/2" W x 4" D / 15.2cm L x 1.3cm W x 10.2cm D Medium Hip Guide Pad Size - 8" L x 1/2" W x 4" D / 20.3cm L x 1.3cm W x 10.2cm D Large Hip Guide Pad Size - 10" L x 1/2" W x 4" D / 25.4cm L x 1.3cm W x 10.2cm D				
	Hip Guide Pad - Small Slimline RH	1504227	RH	£41
	Hip Guide Pad - Small Slimline LH	1504215	LH	£41
	Hip Guide Pad - Medium Slimline RH	1504228	RH	£41
	Hip Guide Pad - Medium Slimline LH	1504217	LH	£41
	Hip Guide Pad - Large Slimline RH	1504229	RH	£41
	Hip Guide Pad - Large Slimline LH	1504218	LH	£41
<b>Pro-tech Wheelchair Back System - Hip/Thigh Guide Standard - Pad Only</b>				
Small Hip Guide Pad Size - 6" L x 1" W x 4" D / 15.2cm L x 2.5cm W x 10.2cm D Medium Hip Guide Pad Size - 8" L x 1" W x 4" D / 20.3cm L x 2.5cm W x 10.2cm D Large Hip Guide Pad Size - 10" L x 1" W x 4" D / 25.4cm L x 2.5cm W x 10.2cm D				
	Hip Guide Pad - Small Standard RH	1504230	RH	£41
	Hip Guide Pad - Small Standard LH	1504219	LH	£41
	Hip Guide Pad - Medium Standard RH	1504231	RH	£41
	Hip Guide Pad - Medium Standard LH	1504220	LH	£41
	Hip Guide Pad - Large Standard RH	1504232	RH	£41
	Hip Guide Pad - Large Standard LH	1504221	LH	£41

Order No :  
Customer Ref :

Pro-tech Spares  
11 of 14

Subject to Invacare's standard terms and conditions.  
Invacare reserves the right to alter product specification without prior notice

Tel: 01656 776222 Fax: 01656 776220

Email: [ordersuk@invacare.com](mailto:ordersuk@invacare.com)

[www.invacare.co.uk](http://www.invacare.co.uk)

Pro-tech spares  
**April 2020**

Pro-tech Wheelchair Back System - Drop Seat Complete Kit 7/8"				
Pro-tech Wheelchair Back System - Complete Drop Seat Kit to fit 7/8" tube, consisting of 1 Drop seat board, 4 L-Brackets, 2 Tension hooks, 2 Aluminium Easy Clamps, 2 Stoppers, 2 U Clamps, weldnuts and fasteners				
NB. The actual width of the drop seat board will measure 2 3/4" or 7cm narrower than the frame width. For example, the 18" or 45.72cm seat board will be 15 1/4" or 38.7cm wide, to fit an 18" or 45.72cm seat frame				
Model	Description	Part Number	UOM	Net Price
	Drop Seat 12" Wide x 12" Deep 30.48cm Wide x 30.48cm Deep to fit 7/8" tube	1503979	EA	£199
	Drop Seat 12" Wide x 14" Deep 30.48cm Wide x 35.56cm Deep to fit 7/8" tube	1503980	EA	£199
	Drop Seat 14" Wide x 14" Deep 35.56cm Wide x 35.56cm Deep to fit 7/8" tube	1503981	EA	£199
	Drop Seat 16" Wide x 14" Deep 40.64cm Wide x 35.56cm Deep to fit 7/8" tube	1503982	EA	£199
	Drop Seat 14" Wide x 16" Deep 35.56cm Wide x 40.64cm Deep to fit 7/8" tube	1503983	EA	£199
	Drop Seat 16" Wide x 16" Deep 40.64cm Wide x 40.64cm Deep to fit 7/8" tube	1503984	EA	£199
	Drop Seat 16" Wide x 18" Deep 40.64cm Wide x 45.72cm Deep to fit 7/8" tube	1524143	EA	£199
	Drop Seat 18" Wide x 16" Deep 45.72cm Wide x 40.64cm Deep to fit 7/8" tube	1503985	EA	£199
	Drop Seat 20" Wide x 16" Deep 50.8cm Wide x 40.64cm Deep to fit 7/8" tube	1503986	EA	£199
	Drop Seat 18" Wide x 18" Deep 45.72cm Wide x 45.72cm Deep to fit 7/8" tube	1503987	EA	£199
Drop Seat 20" Wide x 18" Deep 50.8cm Wide x 45.72cm Deep to fit 7/8" tube	1503988	EA	£199	

Tel: 01656 776222 Fax: 01656 776220

Email: [ordersuk@invacare.com](mailto:ordersuk@invacare.com)

[www.invacare.co.uk](http://www.invacare.co.uk)

Pro-tech Wheelchair Back System - Drop Seat Complete Kit 1"				
Pro-tech Wheelchair Back System - Complete Drop Seat Kit to fit 1" tube, consisting of 1 Drop seat board, 4 L-Brackets, 2 Tension hooks, 2 Aluminium Easy Clamps, 2 Stoppers, 2 U Clamps, weldnuts and fasteners				
NB. The actual width of the drop seat board will measure 2 3/4" or 7cm narrower than the frame width. For example, the 18" or 45.72cm seat board will be 15 1/4" or 38.7cm wide, to fit an 18" or 45.72cm seat frame				
Model	Description	Part Number	UOM	Net Price
	Drop Seat 12" Wide x 12" Deep 30.48cm Wide x 30.48cm Deep to fit 1" tube	1503989	EA	£199
	Drop Seat 12" Wide x 14" Deep 30.48cm Wide x 35.56cm Deep to fit 1" tube	1503990	EA	£199
	Drop Seat 14" Wide x 14" Deep 35.56cm Wide x 35.56cm Deep to fit 1" tube	1503991	EA	£199
	Drop Seat 16" Wide x 14" Deep 40.64cm Wide x 35.56cm Deep to fit 1" tube	1503992	EA	£199
	Drop Seat 14" Wide x 16" Deep 35.56cm Wide x 40.64cm Deep to fit 1" tube	1503993	EA	£199
	Drop Seat 16" Wide x 16" Deep 40.64cm Wide x 40.64cm Deep to fit 1" tube	1503994	EA	£199
	Drop Seat 16" Wide x 18" Deep 40.64cm Wide x 45.72cm Deep to fit 1" tube	1524144	EA	£199
	Drop Seat 18" Wide x 16" Deep 45.72cm Wide x 40.64cm Deep to fit 1" tube	1503995	EA	£199
	Drop Seat 20" Wide x 16" Deep 50.8cm Wide x 40.64cm Deep to fit 1" tube	1503996	EA	£199
	Drop Seat 18" Wide x 18" Deep 45.72cm Wide x 45.72cm Deep to fit 1" tube	1503997	EA	£199
	Drop Seat 20" Wide x 18" Deep 50.8cm Wide x 45.72cm Deep to fit 1" tube	1503998	EA	£199





Yes, you can.™

Tel: 01656 776222 Fax: 01656 776220

Email: ordersuk@invacare.com

www.invacare.co.uk

**RETAIL PRICELIST**

Pro-tech spares

**April 2020**

Pro-tech Wheelchair Back System - Drop Seat Board Only				
NB. The actual width of the drop seat board will measure 2 3/4" or 7cm narrower than the frame width. For example, the 18" or 45.72cm seat board will be 15 1/4" or 38.7cm wide, to fit an 18" or 45.72cm seat frame				
Model	Description	Part Number	UOM	Net Price
	Drop Seat 12" Wide x 12" Deep 30.48cm Wide x 30.48cm Deep	1497642	EA	£91
	Drop Seat 12" Wide x 14" Deep 30.48cm Wide x 35.56cm Deep	1497643	EA	£91
	Drop Seat 14" Wide x 14" Deep 35.56cm Wide x 35.56cm Deep	1497656	EA	£91
	Drop Seat 16" Wide x 14" Deep 40.64cm Wide x 35.56cm Deep	1497657	EA	£91
	Drop Seat 14" Wide x 16" Deep 35.56cm Wide x 40.64cm Deep	1497658	EA	£91
	Drop Seat 16" Wide x 16" Deep 40.64cm Wide x 40.64cm Deep	1497659	EA	£91
	Drop Seat 16" Wide x 18" Deep 40.64cm Wide x 45.72cm Deep	1504109	EA	£91
	Drop Seat 18" Wide x 16" Deep 45.72cm Wide x 40.64cm Deep	1497660	EA	£91
	Drop Seat 20" Wide x 16" Deep 50.8cm Wide x 40.64cm Deep	1497661	EA	£91
	Drop Seat 18" Wide x 18" Deep 45.72cm Wide x 45.72cm Deep	1497669	EA	£91
	Drop Seat 20" Wide x 18" Deep 50.8cm Wide x 45.72cm Deep	1497670	EA	£91
Pro-tech Wheelchair Back System - Fixed Drop Seat Transportation Kits				
	12" - 14" Drop Seat Heavy Duty Hardware Kit with 4 L-Brackets, 4 sets of weld nuts & screws.	1503922	EA	£171
	16" - 20" Drop Seat Heavy Duty Hardware Kit with 4 L-Brackets, 4 sets of weld nuts & screws.	1503923	EA	£171
Pro-tech Wheelchair Back System - Drop Seat Hardware Kit - includes 2 Aluminium Easy Clamps, 4 L Brackets, 2 Tension Hooks, 2 Stoppers, 2 U Clamps and Fasteners				
	Drop Seat Hardware Kit for 12" -14" seats to fit 7/8" tube	1497361	EA	£170
	Drop Seat Hardware Kit for 16" -24" seats to fit 7/8" tube	1497829	EA	£170
	Drop Seat Hardware Kit for 12" -14" seats to fit 1" tube	1497386	EA	£170
	Drop Seat Hardware Kit for 16" -24" seats to fit 1" tube	1497830	EA	£170



Tel: 01656 776222 Fax: 01656 776220  
Email: ordersuk@invacare.com  
www.invacare.co.uk

Freedom Seating  
April 2020

Contact: \_\_\_\_\_  
Service/PCT: \_\_\_\_\_  
City: \_\_\_\_\_  
Phone Number: \_\_\_\_\_  
Marked For: \_\_\_\_\_  
Purchase Order # \_\_\_\_\_

Client reference \_\_\_\_\_

Assessment Date \_\_\_\_\_

- Special request required
- Quote
- Order
- E-mail Address \_\_\_\_\_
- Fax Number \_\_\_\_\_

**Wheelchair Specifications:**

Model: \_\_\_\_\_  
Width: \_\_\_\_\_  
Depth: \_\_\_\_\_

**Seating Specifications:**

A - Back Height \_\_\_\_\_  
B - Lateral Height \_\_\_\_\_  
C - Lateral Width \_\_\_\_\_  
D - Hip Width \_\_\_\_\_  
E - Set Up Seat Depth \_\_\_\_\_  
G - "E" + 3" for Growth \_\_\_\_\_  
H - Seat Width \_\_\_\_\_  
I - Back Width \_\_\_\_\_

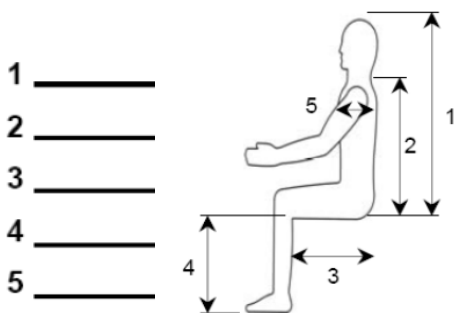
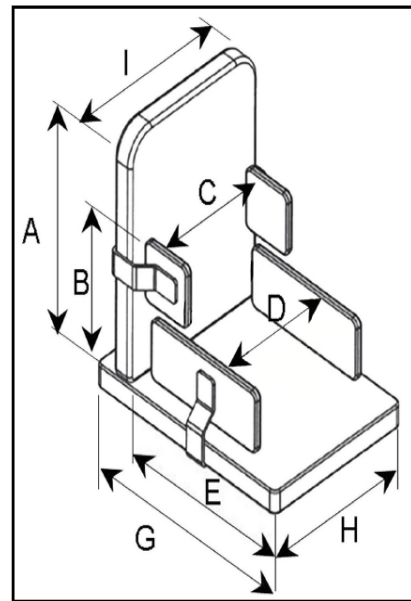

**Supine**

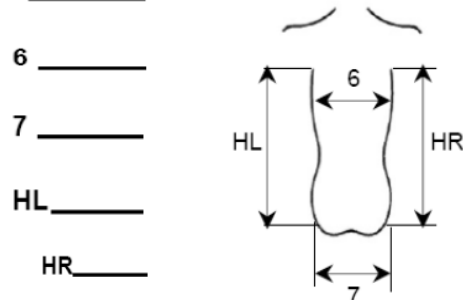

**Special Request**

Please fill out any special requests you may have here:			
Part number	Description	Quantity	Net Price

**Notes**

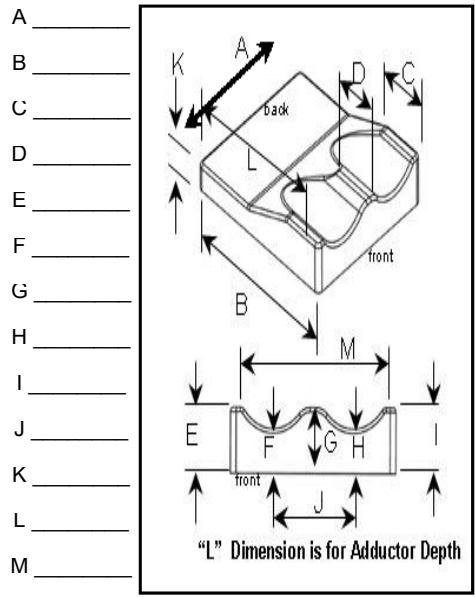

Tel: 01656 776222 Fax: 01656 776220  
Email: ordersuk@invacare.com  
www.invacare.co.uk

Freedom Seating  
**April 2020**

**Upholstery and Monograms:**

Client \_\_\_\_\_

Total system covered in:  Black Wipedown  Black Smooth

Contact Surface:  Black Wipedown  Black Smooth Non-contact Surface:  Naugahyde  Lycra

Naugahyde Color Choices:

- |  |  |  |   |
|--|--|--|---|
| <input type="checkbox"/> K-16 Nutmeg (Red Sparkle) | <input type="checkbox"/> K-09 Bright Yellow  | <input type="checkbox"/> F-09 Royal Blue | <input type="checkbox"/> K-10 Bright Green    |
| <input type="checkbox"/> F-117 Orange Sizzle       | <input type="checkbox"/> K-17 Sparkle Purple | <input type="checkbox"/> F-28 Bright Red | <input type="checkbox"/> F-112 Purple Passion |
| <input type="checkbox"/> F-118 Lime Punch          | <input type="checkbox"/> F-119 Rosalee       | <input type="checkbox"/> F-75 Space Blue | <input type="checkbox"/> F-124 Shimmer        |

Monogram Name: \_\_\_\_\_

Font:  Script OR  **BLOCK**

Name Colour \_\_\_\_\_

**Step 1. Choose Hardware for Planar / Flat Seat**

Note: Price includes 1/2" wood & 1-1/2" 4# foam.

- |                                     |   |      |
|-------------------------------------|---|------|
| <input type="checkbox"/> EE1        | Seat - Econo-eze 2 point hardware (Add Back Hardware)                 | £349 |
| <input type="checkbox"/> Fastclamp1 | Seat - Fast Clamp 2 point hardware (Add back hardware)                | £294 |
|                                     | <input type="checkbox"/> 1" posts <input type="checkbox"/> 7/8" posts |      |
| <input type="checkbox"/> 101-7500   | Seat -Econo-eze 4 point hardware                                      | £381 |

**Step 2. Choose Modifications to Planar / Flat Seat**

- |   |          |   |          |
|---|----------|---|----------|
| <input type="checkbox"/> Mod-1K Anti-Thrust Seat Foam | Add £120 | <input type="checkbox"/> Mod-1Y Contour Abd/Anti Thrust/Add | Add £205 |
|---|----------|---|----------|

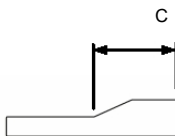

\* Height of anti-thrust shelf is 1"  
\* C = 3rd of set up seat up depth  
Specify if other \_\_\_\_\_

(see page 2)

- |   |                           |   |          |
|---|---------------------------|---|----------|
| <input type="checkbox"/> Mod-1V Contour Abd/Anti Thrust | Add £160                  | <input type="checkbox"/> Mod-1W Contour Add/Anti Thrust | Add £160 |
| <input type="checkbox"/> Mod-1U Removable Seat Cover    |                           |   | Add £59  |
| <input type="checkbox"/> Mod - 1I                       | Incontinent Liner—Plastic |   | £18      |

**2 Point Pelvic Positioning Belt**

Add £34

- SB-3331-S Centre pull/pls Push Button - Small
- SB-3331-M Centre pull/pls Push Button - Medium
- SB-3331-L Centre pull/pls Push Button - Large

**4 Point Pelvic Positioning Belt**

Add £102

- IVC-NXT-SFDI 3AP4-S
- IVC-NXT-SFDI 3AP4-M
- IVC-NXT-SFDI 3AP4-L

Tel: 01656 776222 Fax: 01656 776220  
Email: ordersuk@invacare.com  
www.invacare.co.uk

Freedom Seating  
April 2020

**Step 1. Choose Hardware for Planar / Flat Back**  
Note: Price includes 1/2" wood & 1" 4# foam.

Client \_\_\_\_\_

- |                                     |   |      |
|-------------------------------------|---|------|
| <input type="checkbox"/> EE2        | Back - Econo-eze 2 point hardware (Add Seat Hardware)                 | £349 |
| <input type="checkbox"/> Fastclamp2 | Back - Fast Clamp 2 point hardware (Add seat hardware)                | £294 |
|                                     | <input type="checkbox"/> 1" posts <input type="checkbox"/> 7/8" posts |      |
| <input type="checkbox"/> 102-7500   | Back -Econo-eze 4 point hardware                                      | £381 |

**Step 2. Choose Modifications to Planar / Flat Back**

- Mod-2I Curved Back-Wood Add £75
- Mod-2IA Curved Back-Foam Add £67

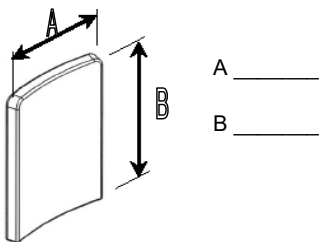

- Mod-2H I-Modification Add £72

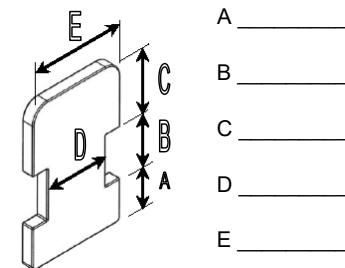

- Mod-2DD Built-In Adj.Lumbar Support Add £170

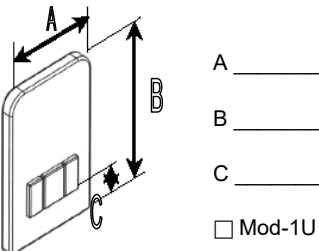

- Mod-2J T-Modification Add £72

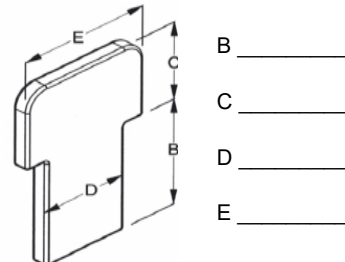

- Mod-1U Removable Seat Cover Add £59

- IVC-NXT-6B Strap risers pair Add £24

**Medial Thigh - Abductor/Pommel**

Client \_\_\_\_\_

- EE3A Adjustable/Removable Pelvic Stabilizer £166
- EE3S Push Button Flip Down Abductor £277

Standard Sizes	
<input type="checkbox"/> Small	3L x 3H x 3-2 Taper
<input type="checkbox"/> Medium	4L x 3H x 3-2 Taper
<input type="checkbox"/> Large	5L x 4H x 4-2 Taper
<input type="checkbox"/> X-Large	6L x 5H x 5-3 Taper

**Hip Guides**

- EE4A-450A Laterals-L Bracket-Std 4# £157/pr
- EE4B-442 Laterals-Offset- 1" O/S4# £157/pr
- EE4B-443 Laterals-Offset- 2" O/S4# £157/pr
- EE4B-442B Laterals-Offset- 1" REV O/S4# £157/pr
- EE4D-STD Hanger Mounted Adductor-Std 4# £419/pr
- EE4D-78 Hanger Mounted Adductor—7/8" £419/pr
- EE4E-450A Laterals Fix/Arm Hgt. Adj.-Std 4# £222/pr
- EE4E-442 Laterals Fix/Arm Hgt. Adj.-1" O/S £222/pr
- EE4E-443 Laterals Fix/Arm Hgt. Adj.-2" O/S £222/pr
- Mod-4A Custom Contour £59/pr

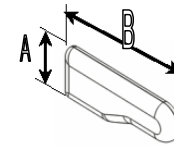

A = 4" high or \_\_\_\_\_"  
B = Set up seat depth or \_\_\_\_\_"

**Trunk Supports**

- EE5A Fixed Thoracic Support - STD 4# £157/pr
- EE5B-442 Thoracic Support-1"O/S-Std 4# £157/pr
- EE5B-443 Thoracic Support-2" O/S Std 4# £157/pr
- EE5B-442B Thoracic Support-1" Reverse O/S £157/pr
- EE5I Tracks-Thoracic Support (Chose size) £34/pr
- EE5J-450C Fixed Thoracic-Summer Winter-Std 4# £264/pr
- EE5J-442C Fixed Thoracic-Summer Winter-1"O/S 4# £264/pr
- EE5J-443C Fixed Thoracic-Summer Winter-2"O/S 4# £264/pr
- EE5P-510A S/A Lever Release Thoracic-Std-4# £347/pr
- EE5P-510B S/A Lever Release Thoracic- 1"O/S 4# £347/pr
- EE5P-510C S/A Lever Release Thoracic- 2"O/S 4# £347/pr
- EE5Q-497A S/A Trunks lever w/Summer Winter £448/pr
- EE5Q-497C S/A Trunks lever w/Summer Winter 1" O/S £448/pr
- EE5Q-497D S/A Trunk levers w/Summer Winter 2" O/S £448/pr
- EE5W S/A Thoracic Support push button £318/pr
- Mod-5F Protective Boots £35/pr

- | Pads                            | Tracks                              |
|---------------------------------|-------------------------------------|
| <input type="checkbox"/> Small  | <input type="checkbox"/> 3" Single  |
| <input type="checkbox"/> Medium | <input type="checkbox"/> 5" Single  |
| <input type="checkbox"/> Large  | <input type="checkbox"/> 7" Single  |
|                                 | <input type="checkbox"/> 9" Single  |
|                                 | <input type="checkbox"/> 11" Single |
| Trunk Supports                  | <input type="checkbox"/> 9" Double  |
| Flat <input type="checkbox"/>   | <input type="checkbox"/> 11" Double |
| Curved <input type="checkbox"/> |                                     |

**Headrest Hardware**

- 7700 Standard headrest £99
- 7708 Rock N Roll Headrest £170
- 7709 Rock N Roll Flip Back Headrest £210
- 7733 Adjustable, Universal Headrest Hardware £42
- 77Platemate Platemate £26

**Headrest Pads**

- 7750 Curved pad- 5#  Sm. 11W\* x 3.75H  Med. 11W\* x 3.75H  Lg. 12W\* x 4H  Xlg.12W\*x4H £109
- 7753 Tripad Lock 3-Piece Pad-5#  Sm. 4W x 4H  Med. 5W x 4H  Lg. 5W x 5H £301
- 7756 Soft Healdrest Pad  Sm. 10W x 4H  Med. 12W x 5H  Lg. 13.5W x 4.5 H £99
- 7760 Slimline Headrest Pad  Sm. 8W x 4.5H  Med. 10W x 4.5H  Lg. 12W x 4.5H  Xlg. 14W x4.5H £99
- 7757 Occipital low profile  Sm. 8W x 4.5H  Med. 10W x 4.5H  Lg. 12W x 4.5H  Xlg. 14W x4.5H £99

\* Outside Width

Tel: 01656 776222 Fax: 01656 776220  
Email: ordersuk@invacare.com  
www.invacare.co.uk

Freedom Seating  
**April 2020**

Client \_\_\_\_\_

**Foot Boxes**

08-10000 Leg Cradles

- Footplate/Footboard Mount    £360
- Hanger Mount

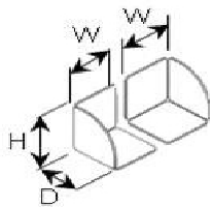

W-Fits between hangers

D \_\_\_\_\_

H \_\_\_\_\_

08-11000 Foot Box

- Footplate/Footboard Mount    £307
- Hanger Mount

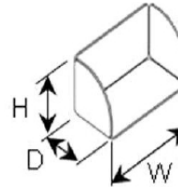

W-Fits between hangers

D \_\_\_\_\_

H \_\_\_\_\_

**Shoe Holders**

SFDI-9BB Select Line High Tops    £86



- Small    4.5" x 7.5"
- Medium    5" x 9"
- Large    5.5" x 10"

**Trays**

What is the width of the frame \_\_\_\_\_ ?

- 08-12000    EZ-Lite 1/4" thick Lexan Tray    £117
- 08-13000    EZ-Lite 1/4" thick Lexan Tray with Ribs    £126

Tray Sizes	
Size	Description
<input type="checkbox"/> X- Small	10" - 11" wide chair, Tray dimensions—21"wide x 18" deep, body cut out— 10" w x 7" deep
<input type="checkbox"/> Small	12" - 13" wide chair, Tray dimensions—21"wide x 18" deep, body cut out— 12" w x 7" deep
<input type="checkbox"/> Medium	14" - 15" wide chair, Tray dimensions—24"wide x 22" deep, body cut out— 14" w x 9" deep
<input type="checkbox"/> Large	16" - 17" wide chair, Tray dimensions—26"wide x 24" deep, body cut out— 16" w x 10" deep
<input type="checkbox"/> X- Large	18" - 19" wide chair, Tray dimensions—28"wide x 24" deep, body cut out— 18" w x 10" deep